

SCIENTIFIC AMERICAN

[Entered at the Post Office of New York, N. Y., as Second Class Matter. Copyright, 1901, by Munn & Co.]

A WEEKLY JOURNAL OF PRACTICAL INFORMATION, ART, SCIENCE, MECHANICS, CHEMISTRY, AND MANUFACTURES.

Vol. LXXXIV.—No. 14.
ESTABLISHED 1845.

NEW YORK, APRIL 6, 1901.

\$3.00 A YEAR.
8 CENTS A COPY.

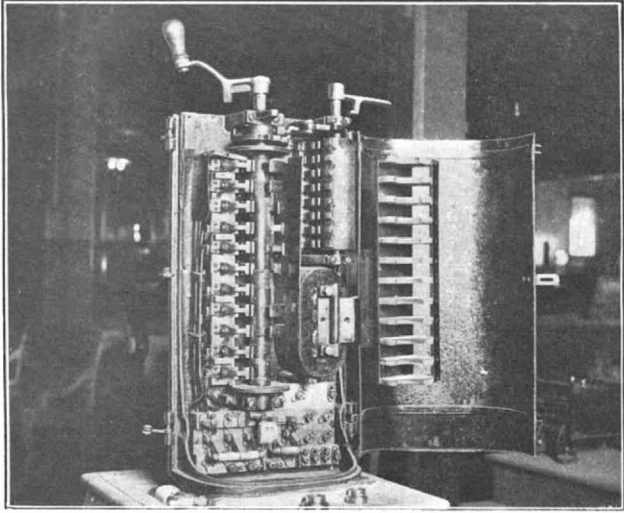

Electric Car Controller.

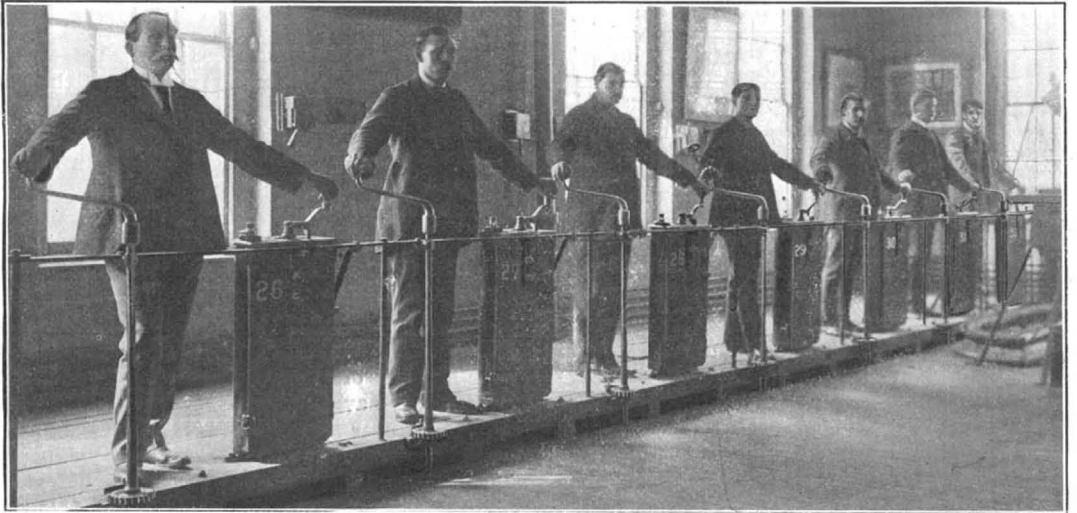

Brake and Controller Instruction.

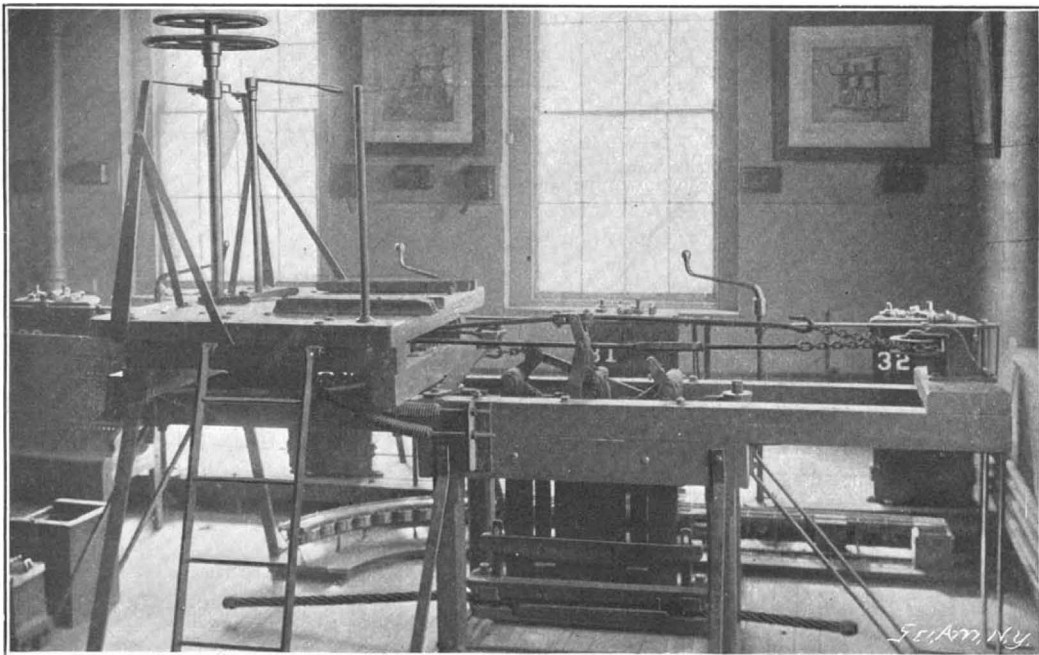

Cable-Car Grip.

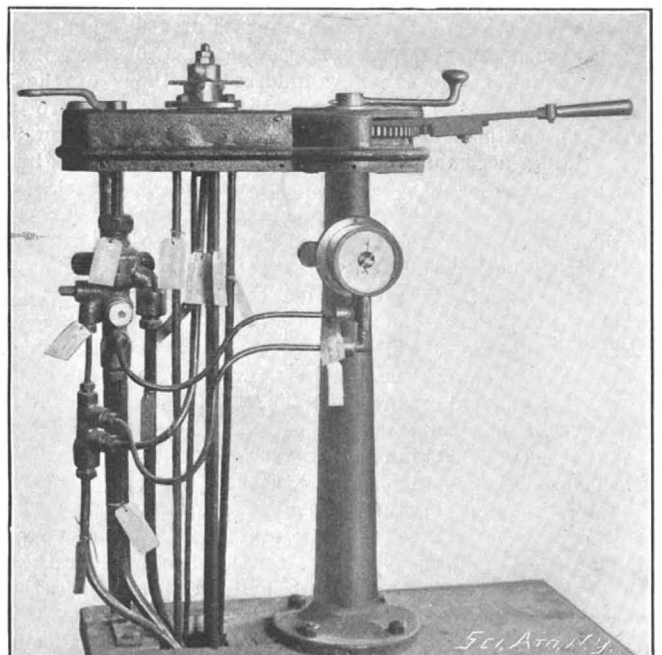

Compressed-Air Car-Controlling Gear.

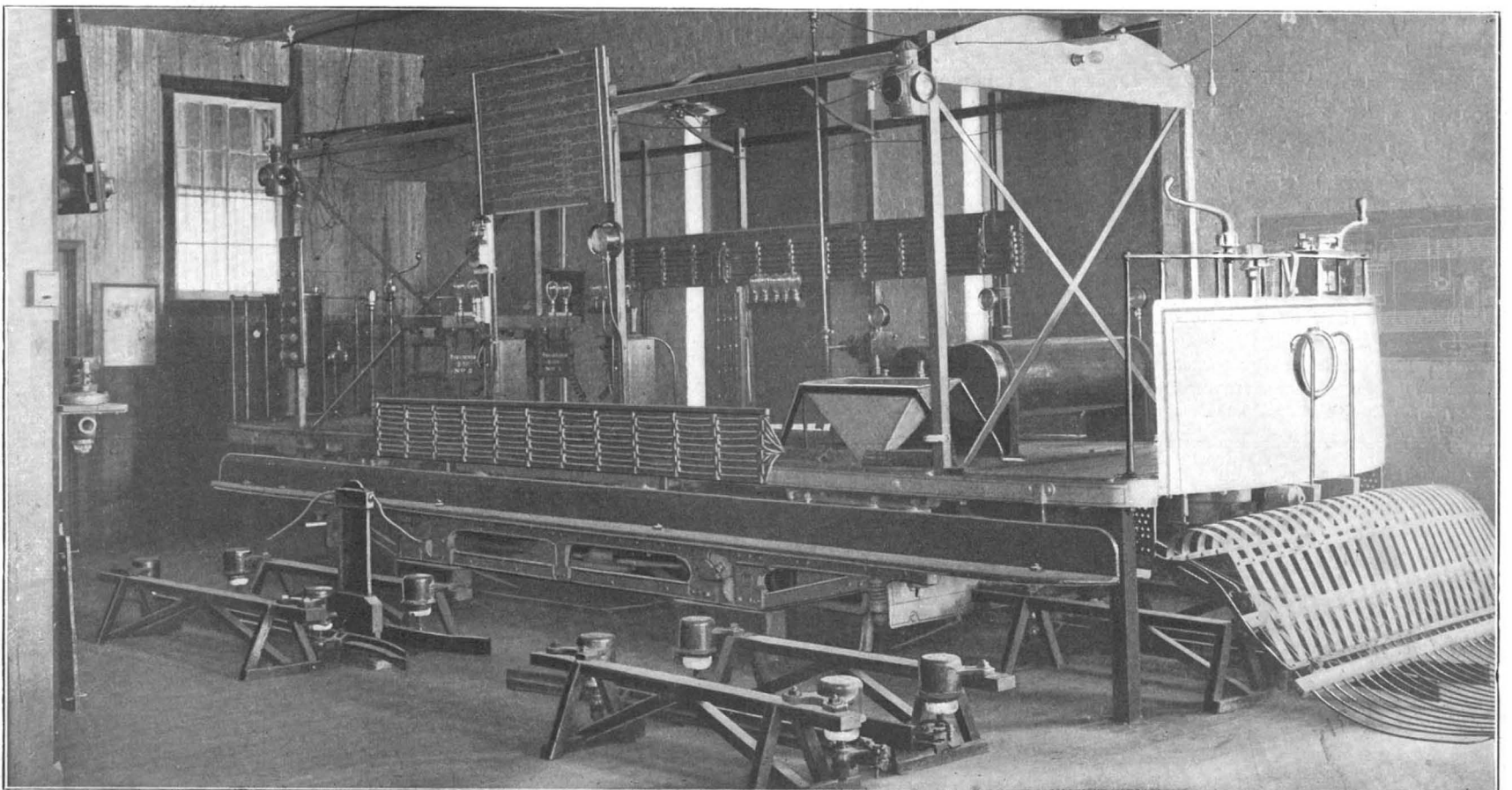

Electric Car and Section of Feeder Rails.

TRAINING SCHOOL FOR NEW YORK STREET-CAR MOTORMEN.—[See page 214.]

Scientific American.

ESTABLISHED 1845

MUNN & CO., - - - EDITORS AND PROPRIETORS.

PUBLISHED WEEKLY AT

No. 361 BROADWAY, - - NEW YORK.

TERMS TO SUBSCRIBERS

One copy, one year, for the United States, Canada, or Mexico \$3.00
 One copy, one year, to any foreign country, postage prepaid, £0 16s. 5d. 4.00

THE SCIENTIFIC AMERICAN PUBLICATIONS.

Scientific American (Established 1845) \$3.00 a year
 Scientific American Supplement (Established 1876) 5.00 ..
 Scientific American Building Edition (Established 1885) 2.50 ..
 Scientific American Export Edition (Established 1875) 3.00 ..

The combined subscription rates and rates to foreign countries will be furnished upon application.

Remit by postal or express money order, or by bank draft or check.
 MUNN & CO., 361 Broadway, corner Franklin Street, New York.

NEW YORK, SATURDAY, APRIL 6, 1901.

The Editor is always glad to receive for examination illustrated articles on subjects of timely interest. If the photographs are sharp, the articles short, and the facts authentic, the contributions will receive special attention. Accepted articles will be paid for at regular space rates.

PROSPECTS OF THE NEW ERIE CANAL.

In reply to a committee from the Commerce Convention in Syracuse, Governor Odell has expressed himself as being opposed to the policy of urging the Legislature to authorize the construction of the Erie Canal along the lines of the scheme which was strongly indorsed by his predecessor. As an alternative, the Governor is in favor of the completion of what is known as the project of 1895.

The canal, with the exception of such work as has been done in carrying out the 1895 scheme, is in the condition in which it was left after the enlargement of 1862. It has a depth of 7 feet, a bottom width of 52 feet and is capable of accommodating boats of 240 tons, with a capacity of 8,000 bushels of wheat. The plan of 1895, which is the one now indorsed by the Governor, provides for the deepening of the canal to 9 feet, with top and bottom widths of 73 and 49 feet, thereby providing accommodation for boats of 450 tons, with a capacity of 15,000 bushels of wheat. It provides for a single pneumatic, or some other form of single mechanical lift at Cohoes and Lockport, together with other changes at important points along the route of the canal. The estimated cost of this project is \$2,161,645.

The alternative scheme, which was reported upon about twelve months ago by the Special Committee on Canals, calls for the enlargement of the canal to a depth of 12 feet, and a bottom width of 75 feet, with capacity for barges of 1,000 tons carrying 33,335 bushels of wheat. The scheme is estimated to cost \$62,000,000; and it was drawn up on these ambitious lines because it was felt by the committee, in view of the recent completion of the Canadian system of canals with a minimum depth of 14 feet throughout, and in view of the strenuous effort which is being made to divert the Western wheat trade to Canadian ports, that the time had come to enlarge the Erie Canal sufficiently to enable it to compete successfully against its well-equipped rival. It was found that the 9-foot canal, while it was a decided improvement, as far as it went, would be altogether inadequate to meet the present emergency. The larger scheme, it was urged, would have a capacity of 20,000,000 tons per annum, and that the saving on that tonnage as compared with the present canal would be \$12,200,000 per annum. The proposed canal could carry freight at a third of the cost by rail, and, as compared with the lowest rail-rate ever quoted, the saving across the State of New York, on a prospective tonnage of 20,000,000 tons, would be about \$18,000,000 per annum.

After a careful study of the question, the Governor says he is satisfied that, on account of the strong opposition in some sections of the State against any further use of the State's money for canal purposes, it will be impossible to secure favorable legislation for the expenditure of the \$62,000,000 required for the larger scheme. He is satisfied that the 9-foot canal would be regarded by the Legislature in the nature of a compromise, and that the necessary money for its construction could be secured.

We thoroughly agree with the Governor in his conviction that if anything is to be done in the way of improvement in the Erie Canal, it must be done at once, and that if the question should be allowed to lie dormant a few years longer, it might be impossible to secure appropriations of any kind for canal improvement. At the same time, we cannot but feel that if the citizens of this State, particularly those that live in what are known as the "granger counties," could be induced to look upon the question broadly, and not merely from the viewpoint of local interests, they would see that the construction of the 12-foot canal would promote the interests, not only of the terminal points at Buffalo and New York, but indirectly, by the multitudinous and far-reaching benefits

which always accrue from a general increase of trade, the interests of the whole State. It is scarcely to the point that Governor Odell should draw a contrast between the crowded state of the canal docks in his boyhood's days and their comparatively deserted condition just now. In those days, not only was railroad competition less severe, but the canal, as such, was adequate in conveniences and methods to the necessities of the time; whereas to-day in its present condition, it is as much out of date as a system of one-horse street cars would be on the Broadway surface line in this city. With a 12-foot canal and 1,000-ton barges, the economic conditions of operation would be so vastly improved that we think the Governor would soon witness a return to the prosperous conditions of an earlier day.

WATER-TUBE BOILERS IN THE BRITISH NAVY.

At a time when our naval authorities are adopting the water-tube boiler, exclusively, for use in our new warships, the recent adverse report of the British Admiralty Committee against the use of the Belleville water-tube boiler cannot but excite great interest in this country. Indeed, the British navy is so vast, and its constructors and engineers have been in the main so successful in producing permanent types of vessels, that a reversal of their policy, involving the practical condemnation of the boiler power of the numerous and powerful ships that have been built during the past four or five years, has produced a pronounced sensation throughout the whole naval world.

The determination to adopt this boiler was made after a series of trials carried out in one of the gun-boats of the navy, and the "Powerful" and "Terrible," cruisers of over 14,000 tons displacement and 22 knots speed, were the first important vessels in which it was placed. Following close upon the trials of these ships came the announcement that the Admiralty had decided to install the Belleville boiler in all future battleships and cruisers. The "Powerful" and "Terrible," however, had not been long in service before complaints began to be heard against the performance of the new boilers under daily service conditions. There were difficulties in maintaining the desired steam pressure, and they proved to be very extravagant in coal consumption. Although a consumption of fuel of about 1.8 pounds per indicated horse power per hour was given out as the result of a trial, it was found that the average consumption of the same ship, when cruising, was between 2.5 and 2.8 pounds per indicated horse power per hour. When we compare this with the consumption of 1.3 pounds, actually recorded last season on the fastest transatlantic steamer, and with the consumption of 0.97 pound recently achieved on a 400-mile trial of one of the freighters of the Inch Line of steamers, it can be seen that an adverse report from the Admiralty Committee was a foregone conclusion. We cannot do more than briefly summarize the more important findings of the committee, and must refer our readers to the current issue of the SUPPLEMENT for the full report.

In the first place, the committee are of the opinion that the advantages of the water-tube boiler, from the military point of view, are so great that, provided a satisfactory type can be found, it is preferable to the ordinary cylindrical type. They do not consider that the Belleville boiler has any such advantage over other types of water-tube boilers as to lead them to recommend it. The principal objections of the committee to this type are that the circulation of the water is defective; that an automatic feeding apparatus of a delicate and complicated kind is necessary; that a great excess of pressure is required in the feed pipes and pumps over the boiler pressure; that the water-gages do not reliably indicate the water-level; and that the up-keep of the Belleville boiler has so far proved to be more costly than that of the cylindrical boilers; while the additional evaporating plant required and the greater coal consumption on ordinary service as compared with cylindrical boilers, has hitherto nullified to a great extent, the saving of weight effected by its adoption. Lastly, the evidence before the committee showed that a large proportion of the coal expended in the navy is used to distill water and for other auxiliary purposes; and for such purposes the cylindrical boiler is considered to be more suitable and economical than any type of water-tube boiler. The report recommends that, as regards future ships that may be authorized, the Belleville boilers should not be fitted; as regards ships recently ordered, on which not much work has been done on the boilers, the boilers be not fitted; while the boilers are to be retained on completed ships and on those under construction, in which any alteration would delay completion.

While condemning this particular type, the committee is fully alive to the manifest military advantages of water-tube boilers as such; and they recommend an extended trial of four types of straight-tube boilers, which are now being adopted in foreign navies. These are the Babcock & Wilcox, the Niclausse, the Dürr, and the Yarrow large-tube boiler. It will thus be seen that a large section of the most recent ships of the

British navy is equipped with a boiler which its own expert committee condemn, a fact which proves that in naval, as in many other matters, it is well to make haste slowly.

LONGITUDINAL FRAMING FOR THE HERRESHOFF CUP-YACHT.

Each of the two yachts that are being built for the defense of the "America" cup will present decided features of novelty among boats of their size and purpose. The Crowninshield yacht, as we pointed out in our issue of March 30, presents novelty of form, being for a 90-foot craft a wide departure from the Herreshoff model, and a purely original creation. The new Bristol boat, on the other hand, will adhere closely to the "Columbia" in form, but will differ radically from her in construction, her designer having broken away from traditional ideas—at least, in yacht construction—by substituting longitudinal framing for the transverse framing by which, from time immemorial, the boat-builder has given his craft the necessary strength. In the transverse system, as followed in "Independence," the form of the boat is preserved by 79 frames, spaced 21½ inches apart (not 2½ feet, as, by a typographical error, was stated in our last issue), and the longitudinal strength is afforded by tie-rod trussing in the overhangs, by side and bilge stringers, and by the natural resistance to distortion of the hull and deck plating, acting in a general way as a tubular girder. On this system, the transverse framing is the fundamental feature, and the longitudinal system is subsidiary to it. In the new Bristol boat, the main framing is longitudinal, and the transverse frames are worked in as subordinate and auxiliary. The result is a reduction in the total weight of material for a given strength. The idea is new in yachts, but not in naval architecture, Brunel having built the "Great Eastern" half a century ago on this system. It is stated that Herreshoff has reduced hull weights 25 per cent as compared with "Columbia." This is manifestly impossible; if he has saved from 7 to 10 per cent, he has done well.

OUR ADVANCING TRADE.

Although the recent increase in the exports of iron and steel manufactures from the United States has been simply phenomenal, there is at present no sign of falling off of the rate of increase. An analysis of the February export figures shows that for the eight months ending with February, 1901, the total export is six and a half millions greater than the truly phenomenal figure of last year, and nearly three times the total for the eight months ending with February, 1891, which means an increase of 10 per cent in a single year, and 333 per cent in the decade. In the eight months ending with February, 1901, iron and steel formed 3 per cent of the total domestic exports, whereas in the eight months just ended they formed 7 per cent. These total figures are particularly gratifying when it is known that the exports cover a great diversity of products, thus proving not only that our manufacturers are rapidly increasing their output, but that they are each year fabricating a large proportion of the product, and thereby securing for themselves and for the labor employed the greater share of the profits arising from such manufacture. Thus, ten years ago, such articles as typewriters, cash-registers, pumping machinery, electrical machinery, and other articles requiring a high degree of manufacture, had no place in the export schedules of the United States; whereas now they constitute an important part of our annual exportations of iron and steel, and are steadily increasing both in volume and in the number of foreign markets in which they find profitable sales. To take a single instance, we may quote electrical machinery, in which in 1891 no exports whatever were recorded; while in 1900 the figures for the transactions of two-thirds of the year had reached about \$2,500,000. For a similar period in the present year they had risen to over \$3,500,000. Another gratifying feature is the fact that the area of distribution steadily and rapidly enlarges. Exports which formerly went only to the principal countries of Europe are now shipped to China, Japan, Australasia, Africa, and the islands of the South Sea, where such articles as sewing machines and typewriters find a market in the most distant islands.

SYLVICULTURE AND THE SUEZ CANAL.

In an interesting article on the above topic, the Revue des Questions Scientifiques describes as follows the highly successful efforts of the Suez Canal Company to protect the banks and approaches of that great highway of the world's commerce by a systematic planting of trees and shrubs of various sorts.

The Suez Canal Company is utilizing to great advantage saplings, shrubs, and large trees in order to consolidate its banks, and to preserve the maritime canal from the encroachments of the desert. The operation began in 1897, and was continued from year to year with the improvements suggested by experience.

For the purpose of diminishing the effects of erosion at the edge of the banks of the maritime canal, and of the swells caused by the passage of vessels, there has been planted at the water's edge a reed of unusual dimensions, the *Arundo gigantea*, which spreads its roots rapidly in the water and quickly attains a height of from ten to twenty feet. Farther back, on the slopes of the banks, there is employed with success several varieties of tamarisks (*T. gallica*, *T. nilotica*, *T. articulata*), whose branches take root when the sand hills just cover them, and which are intermingled with herbaceous plants like the orach (*Atriplex halium*) and the alfa (*Stipa tenax*).

In addition to the foregoing precautions it was necessary to protect the canals from the encroachment of the desert sands driven by the wind. To accomplish this there has been established, at about 350 feet from the water's edge, hedges formed of arborescent species, and 170 feet long. The flao, with horsetail leaves (*Casuarina equisetifolia*), an Australian tree quite well naturalized in Egypt, the acacia of the Nile (*A. nilotica*), the eucalyptus globulus et robusta; the cypress of Lambert; the caoutchouc and Bengal fig trees (*Ficus elastica*, *F. bengalensis*); poplars, mulberry trees and even the sycamore generally thrive well on these plantations, especially in silicious soils; this, however, is due to artificial irrigation obtained by cutting ditches from the fresh water canals derived from the Nile for the sustenance of the inhabitants.

Vegetation is more rebellious where the soil is found to be argillaceous, compact or too solid. In order to overcome this the lime-bearing waters of the Nile have been brought down, after much labor, and now a number of tamarisks, willows, orachs and other trees thrive well.

On the banks where the swells of passing vessels would endanger the young plantations of reeds, they are sheltered, for the first few years, by hurdles which are taken elsewhere when the plants thus protected have acquired sufficient strength.

THE HEAVENS IN APRIL.

BY HENRY NORRIS RUSSELL, PH. D.

Although Mars is now some time past opposition and more than eighty million miles distant, he is still the most interesting object in our evening skies; and this not so much for what we know about him, as what we imagine.

The belief in his habitability, rather strengthened than diminished by the discoveries of recent years, but as yet incapable of proof or disproof, finds its most appealing presentation to the public mind in the idea of possible signaling between men and the inhabitants of the planet.

Let us for the present assume that such intelligent inhabitants exist, and that the Martian canals are their work. We may then go on to consider what signaling to them involves, and whether it would be mechanically possible.

At the outset we are limited to two ways of signaling—by means of light, and by the electric waves of the same nature but enormously longer period used in wireless telegraphy, since these alone, of all earthly means of communication, can pass through interplanetary space. Of these two, light is by far the most promising, as the unaided eye can detect a far smaller amount of energy in that form than the most delicate instruments can in the form of electric waves.

When Mars is nearest us, the earth is almost directly between him and the sun. In consequence we can only see Mars at night, and his sunlit side is turned toward us. From Mars, on the contrary, only the dark side of the earth can be seen, and that in the Martian daytime. Therefore signals from the earth to Mars would have to be made by artificial light, while those in the reverse direction might be made with reflected sunshine. Moreover, our signals would be obscured by the glare of the Martian sky close to the sun; while theirs would have only the light of the planet and stars to interfere with them. For both these reasons it is much easier for the Martians to signal to us than for us to reply, and therefore we will first calculate on the supposition that they are flashing to us with reflected sunlight.

It is surprising how small a mirror will suffice to produce signals visible at a considerable distance in broad daylight. One three inches in diameter gives flashes which are conspicuous to the naked eye ten miles away. Indeed, this is the system of heliographing messages of which we have heard so much from South Africa. The writer has no available data as to the minimum size of mirror which can be used. It is, however, probably safe to allow an inch of diameter of the mirror for each ten miles of distance if the signals are to be clearly read by the naked eye, and we will use this ratio in our work.

In the case of Mars the signals would be observed with large telescopes transmitting perhaps 10,000 times as much light as enters the naked eye from the same object. In consequence the Martians' mirror need have only 1-10,000 of the area or 1-100 of the diameter that

our heliograph rule would require. We need make no extra allowance for the fact that the Martian signals are to be observed at night, since they would be seen against the bright background of the planet's disk, just as the terrestrial flashes are seen against sunlit sky or hills.

Our final ratio is then one inch of mirror diameter for each thousand miles of distance. Now the least possible distance of Mars is 35,000,000 miles. The mirror with which its inhabitants signaled to us would therefore have to be at least 35,000 inches or nearly 3,000 feet in diameter. To produce such a piece of glass is clearly far beyond the present resources of human engineering. It seems possible, however, that beings who could construct the Martian canals could also make such a mirror, but once made its mounting would present still greater trouble. It would have to be set up so that its plane was equally inclined to the directions of the earth and sun, and moved by some sort of gigantic clockwork, to counteract the planet's rotation just as telescopes have to be moved on earth. To make flashes by covering up the whole enormous structure, or by tilting it, seems hardly possible; but this end could be attained by a mirror composed of parallel strips, like the slats of a window blind, which could all be turned out of their plane at once, and later brought back to place by relatively simple mechanism; the whole to be mounted in a great frame moved by the clockwork spoken of above. No firm on earth would take the contract for such an apparatus; but it does not seem impossible that the human engineering of a few centuries hence might be equal to the task. So we reach the interesting conclusion that it is not inconceivable that men residing on Mars might be able to heliograph messages to us; and we cannot deny the same ability to the Martians, however unlike us they may be.

How hopeless the task of signaling to them would be we can now see. What gigantic conflagration, what combination of all the searchlights of the world, could produce a ray equal in intensity to a solid beam of sunlight a thousand yards across? How could we point them all correctly? And how interrupt their light at will? Remembering that these are the conditions for sending a message from Mars and that it is much more difficult to signal in the reverse direction, we may give up once for all the idea of any regular communication between the two planets.

THE HEAVENS.

As we once more watch the heavens at 9 o'clock on the evenings of the middle of the month, we see that we must soon bid good-bye to many of our old friends among the stars.

Canis Major, Orion, Taurus, and Perseus are all close to the horizon, and before another month has passed we shall lose them all. Cassiopeia, in the far north, escapes a similar fate only because her diurnal circle about the pole does not quite dip below our horizon. Auriga, Gemini, and Canis Minor are higher in the western sky, and we shall not lose them for some time yet.

Ursa Major and Leo are at their highest, fairly on the meridian. Lower down on the east is Virgo, with the brilliant Spica, and the arc of fairly bright stars between it and Leo. Below this is the little but conspicuous quadrilateral of Corvus, the Crow, who is perched on the back of Hydra, whose whole length can now be seen stretching from Canis Minor to Libra.

Arcturus is well up in the east, and Vega has just risen. Between them are the graceful circlet of Corona Borealis, and the extensive constellation Hercules, and below are parts of Ophiuchus and Serpius.

THE PLANETS.

Mercury is morning star all the month. His greatest elongation occurs on the 3d, when he is unusually far from the sun, but as he is also south of him, he rises only about an hour before sunrise.

Venus is morning star till the last day of the month, when she passes through inferior conjunction and resumes the rôle of evening star. She is too close to the sun throughout the month to be well seen.

Mars is still in Leo, moving westward till the 4th, then slowly eastward. He comes to the meridian about 8 P. M., and does not set till nearly three in the morning.

Jupiter is in quadrature with the sun on the first; that is, he is 90 degrees west of him and on the meridian at 6 A. M. Saturn comes to a similar position on the 5th. The two planets are getting quite close together in the constellation Sagittarius and will remain so for some months.

Uranus is farther west, in Scorpio, and rises about 11 P. M. on the 15th. Neptune is in Taurus, nearly opposite the planet last named.

THE MOON.

Full moon occurs on the evening of the 3d, last quarter on that of the 11th, new moon on the afternoon of the 18th, and first quarter on the forenoon of the 25th. The moon is nearest the earth on the 18th, and most remote on the 4th.

She is in conjunction with Uranus on the night of

the 8th, Saturn on the morning of the 11th, and Jupiter on the afternoon of the same day; with Mercury on the morning of the 17th, Venus on the afternoon of the 18th, Neptune on that of the 23d, and Mars on the morning of the 27th.

AUTOMOBILES IN NEW YORK.

The above was the title of an address by G. Herbert Condict, before the New York Electrical Society, on March 27, at the new station of the Electric Vehicle Transportation Company, corner of Forty-ninth Street and Eighth Avenue, in this city. Before a very large audience, standing in an electric runabout for a platform, Mr. Condict related briefly a few facts concerning the rise and growth of electric transportation. He remarked that there were at the present time four hundred and fifty automobile vehicles in New York, as compared with about four thousand horse-drawn. In the next twenty years it was a possibility that no horse-drawn vehicles would be permitted in the streets, and so the vast expense of keeping the latter clean would be saved.

It was during seasons of snow and ice, when the smooth pavements were slippery, that the demand for electric vehicles was the greatest, and frequently overtaxed the facilities of the company. At these times, on one occasion, as many as four hundred calls an hour had been received. The company, of which Mr. Condict is the chief engineer, decided in the spring of 1900 to secure larger quarters, and began the work in August of last year of transforming half of the great building on Eighth Avenue, between Forty-ninth and Fiftieth Streets, formerly used as the Eighth Avenue car stables, where over 1,500 horses were accommodated, into an enlarged station covering three acres, equipped with motor current transformers, which take the Edison alternating current at 3,200 volts and deliver direct current at 110 volts; a special switchboard, which controls the current supply to six hundred separate sets of batteries, with room to spare for controlling one thousand batteries at a time; electric motor automatic water pumps for supplying the roof tank which produces the hydraulic pressure for elevating the sets of batteries and transferring them to and from the vehicles; an immense battery room, ventilated by two large electrically-operated fans in the roof; two great electrically-propelled cranes spanning the room, arranged with separate motors, for lifting and lowering individual sets of batteries from or to the charging fingers on the floor; a battery repair room, a well-equipped machine shop on an upper floor, a motor room for repairing and adjusting motors and parts to vehicles, a blacksmith shop, a paint shop, and adjoining the machine shop a long room having a double trolley wire overhead, on which runs a trolley carriage, and from it the current is conveyed by a flexible wire to a cab for testing the motors and the running of the vehicle without a battery.

When a vehicle comes in for the day the battery is transferred to the charging room, and the vehicle is washed and sent up stairs. There it is carefully inspected, the rubbed plate battery connections are brightened with sandpaper, the motors are cleaned, the vehicle trimmings examined, and the tires blown up. It is then ready for the next day's business.

So complete are all the arrangements that it was stated within fifteen seconds of the receipt of a telephone call a cab is started on the way to answer it.

The station and the system is regarded as the largest in the world, and is the most unique and perfect in all its appointments for the rapid handling of individual batteries and inserting and withdrawing them from vehicles. It represents the possibilities of the practical use and application of electricity on a large scale as applied to transportation. This system was illustrated in the SCIENTIFIC AMERICAN, March 25, 1899.

METHOD OF DETECTING HYPO IN PHOTOGRAPHIC WORK.

The importance of thoroughly eliminating the hypo from negatives or prints in photographic work is so well recognized that it need not be insisted upon, and it will therefore be useful to give a method which has been brought out in the Belgian Photographic Bulletin for detecting small traces of hypo in the washing water and thus observing when the operation is finished. Into a deep tray is poured a small quantity of the water or solution in question and a few pieces of granulated zinc are thrown in, after which add a few drops of hydrochloric acid. Place above the tray a filter paper wet with a solution of acetate of lead. If the least trace of hyposulphite remains in the solution the paper will become brown, and afterward assume a black metallic appearance. This action is due to the formation of hydrogen sulphide, which escapes to the surface and colors the paper by forming lead sulphide. In this way it is always easy to determine when the washing is finished or to examine a solution suspected of containing hypo.

ELECTRICALLY ILLUMINATED FOUNTAINS.

Of late years the electric illumination of fountains has been carried to such a point that the best of them form a spectacular display, which will continue for two hours before the series of designs which can be formed is exhausted. A fountain was recently erected in Philadelphia, which shows over fifty different designs illuminated in various colors by the system of illumination employed. As an amusement feature, these displays have proved very attractive, and city authorities as well as owners of private parks have gone to considerable expense in securing them. In Prospect Park, Brooklyn, a fountain is in operation, which cost \$25,000.

In planning the electric fountains, the basin to contain the water is constructed of stone or concrete in the usual manner, except that portions of the bottom are covered with glass. The electrical apparatus is usually located in a chamber beneath it. The chamber is connected with the surface by an underground passage, which is also used as a conduit for the electric cables. The wires of the cables connect with a stand, or switchboard, containing a series of electric buttons, and extend to lamps of both the arc and incandescent type, placed in the various pipes or funnels, through which the water is forced. The lamps are protected from the water by panes of colored or clear glass, some of them being covered with a set of movable panes which can be swung or whirled by the use of compressed air. Arc lights are utilized for the general illumination, and their rays are intensified by movable reflectors, so that beams can be thrown upon the upper or lower part of the water and at any angle desired. The buttons are colored to represent the tint desired in the illumination. For instance, the operator presses a red button when he wishes to introduce light through the red glass, a yellow button when it is desired to give a yellowish hue, and a green button when it is desired to give a green tint, etc. The designs in water are created by the shapes of the pipes through which it is thrown into the air, and by the arrangement of the holes in them. A conduit supplying a one-inch stream may have its nozzle pierced with holes in the shape of a star, an umbrella, or open to form a single jet, as desired. If its stream is to be thrown vertically into the air the pipe is, of course, placed in a vertical position. If it is to form an angle, the position is varied accordingly. As the larger fountains may have several hundred pipes arranged in various positions in the basin, an idea can be gained of the combinations. The water is conducted from the reservoir or pumping station to the fountain by underground conduits in the usual manner. Valves are set in the conduits and in the smaller pipes, and are connected with the operating chamber in such a manner that each is controlled merely by the pull of a lever. The set of levers is arranged somewhat similar to the apparatus in a railroad block signal station. In planning the display, the piping and wiring are, of course, installed to allow the use of single jets and combinations, and the introduction of colored illumination, as desired. This must all be arranged in advance, as the pipes and wire cables are generally inclosed in concrete, or other waterproof material, after being connected with the various funnels and jets beneath the basin.

Such is the simplicity of operation that only two men are required—one to work the levers, and the other the buttons. A small window of thick glass allows them to note the water formation from their stand in the underground chamber. When the

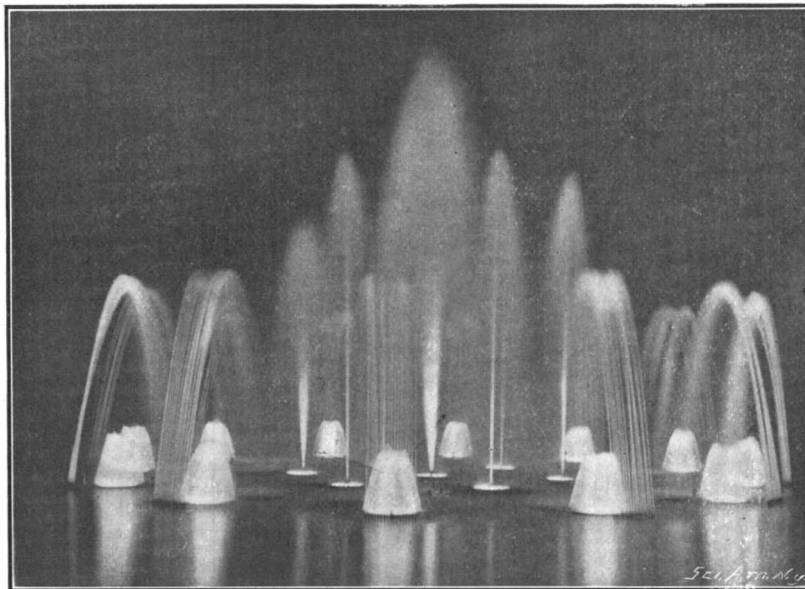
**ELECTRIC FOUNTAIN EFFECTS.**

time for the display arrives, the electrician takes his place at the switchboard, and gives his orders to his assistant. The latter pulls the lever he indicates. As soon as the column of water appears, the electrician illuminates it by pressing a button on the switchboard. If it is a single jet, it is allowed to play for two or three minutes; then several others are added by another pull of the lever. It remains illuminated by the white light until the electrician presses another button and the tint is changed. Different effects are pro-

duced in the same manner. As already stated, the combinations which can be arranged are really remarkable in their extent. The Brooklyn and Philadelphia fountains, which were designed by Mr. F. W. Darlington, of Philadelphia, display umbrellas, various flowers, sheaves of wheat, globes of liquid, and spiral columns which writhe in the air like snakes. At Willow Grove Park, Philadelphia, the arrangement is such that a cascade can be formed in the shape of a fan extended. This constitutes a background, or curtain, on which colored pictures are thrown by means of a stereopticon, giving a novel, yet beautiful, effect.

The quantity of water required varies from a few thousand gallons an hour to as high as 100,000 gallons in the larger fountains. A pressure of from 125 to 150 pounds to the inch is required for the more elaborate displays, and usually the supply is forced to the fountain by a powerful steam or electric pump. There is no necessity for waste, as the water can be forced back to the pumping station or reservoir and used over and over if desired. An electric current of 500 volts is usually sufficient for the illumination. For the larger fountains it is sometimes generated in an individual station, but when they are set up in pleasure grounds owned by street railway companies, or in cities where the municipal authorities have their own electric light plant, the current can be carried from the central station by means of the cable system.

THE NEW RUSSIAN BATTLESHIP "CZAREVITCH" AS SHE WILL APPEAR WHEN COMPLETED FOR SEA.

The sudden effort at expansion in which the Russian navy is just now engaged has led to orders for the building of new battleships and cruisers being distributed in a large number of different places and countries. Like America, France has come in for her share in this business, and one of the most important warships now under construction for the Russian navy in that country is the "Czarevitch," which is being built at the well-known yard at La Seyne, near Toulon, belonging to the Forges et Chantiers de la Méditerranée.

This ship, when complete, will be a big armor-clad of 13,000 tons displacement, bids fair to be a very formidable ship of war, and has that somewhat "ferocious" appearance for which French battleships are conspicuous. Her masts, heavy, castelated, and bristling with guns; her tumble-home sides; her high superstructure and numerous "tourelles," or turrets, all contribute to impress the onlooker with the idea of war-like power. This appearance, like others, is, however, not infrequently somewhat deceptive, but in the present case cannot be considered so, as both in offensive and defensive equipment the "Czarevitch" is extremely well provided.

Her armament consists of four 12-inch guns, twelve 5.9-inch rapid-firing guns, twenty 12-pounders, twenty

-pounders, six 1-pounders, and a couple of 2-pounders, or sixty-four guns in all, equaling the number carried in the old sailing battleships of the early part of the century. Her defensive armor is of considerable area. In the first place, she has a complete belt of armor having a maximum thickness of 9 inches, and upper and lower armored decks, while all her heavier guns are placed in barbette turrets, the heavier of which, containing the four guns forming her principal armament, are 11 inches thick in the turrets, and 10 inches in the barbettes. The hoods of the six turrets containing the twelve rapid-firers of her secondary armament are 6 inches in thickness on barbettes of 5-inch plating.

The "Czarevitch" is provided with

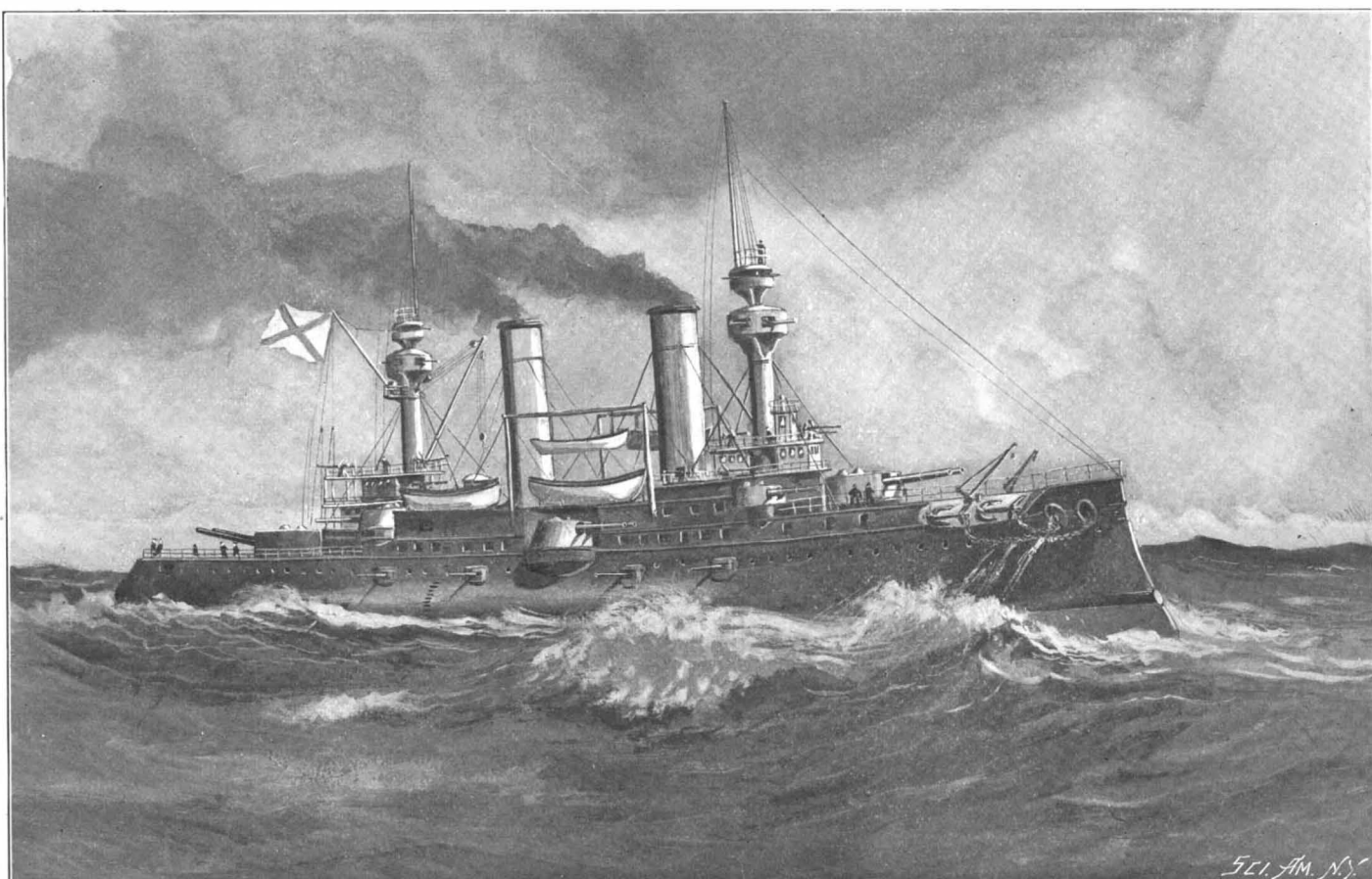
**NEW RUSSIAN BATTLESHIP "CZAREVITCH."**

Displacement, 13,000 tons. **Speed,** 18 knots. **Armor:** Belt, 9 inches; gun positions, 10 and 11 inches for main battery, 5 and 6 inches for secondary battery. **Armament:** Four 12-inch; twelve 5.9-inch rapid-fire guns; twenty 3-inch; twenty 8-pounders and 8 smaller guns. **Torpedo Tubes,** six. **Complement,** 700. **Date,** 1901.

six torpedo-tubes, of which two are below water, the remainder being situated at bow, stern, and on either broadside. The new battleship will be a twin-screw vessel, and is estimated to attain a speed of 18 knots an hour. Belleville boilers, twenty in number, are to be fitted, and will supply steam for two sets of four-cylinder triple-expansion engines, working up to 16,300 horse power. The "Czarevitch" will be fitted with six electric projectors and a complete installation of electric lighting. Electricity, too, will supply the motive power for revolving the turrets and other purposes for which local machinery is required. She is to be fitted as a flagship, and will carry a crew of 700 men.

A SUGAR CANE REAPER WANTED IN HAWAII.

The Hawaiian Sugar Planters' Association have a most important problem to solve, namely, the invention and designing of a reaper for sugar cane in plantation fields. They have set about the problem in an eminently practical manner, offering prizes which aggregate \$8,500. A prize—or reward, as the Association terms it—of \$2,000 is offered for the best practical design of a machine for reaping the cane. This competition will close on the 30th of June, 1901. The design selected is to become the property of the Association, who may cause the machine to be manufactured for actual trial. A further prize, or reward, of \$5,000 is offered for the best working machine that will actually reap cane in the field in a practical manner. This part of the competition will close on December 31, 1901. Should the machine built from the accepted design participate in the actual trials and be successful, the inventor will receive \$3,000 in addition to the \$2,000 which he has already received in the first part of the competition. If the competition is won by a machine not manufactured by the Association, it will be purchased from the inventor by the Association at the cost price delivered in Honolulu. A further prize of \$1,500 is offered for the best design of an apparatus to transport the cane to and load it in railway cars. This competition closes on the 30th of June, 1901. Competitors are required to submit drawings of the machine as a whole, together with full detail-drawings, and only a description where the design is called for. In the second part of the competition, where a machine is called for, competitors will be required to furnish the machines to be experimented with in the field by the board of judges. Should the Hawaiian Sugar Planters' Association accept a design of machine, the payment of the reward will be equivalent to the purchase of all patent rights to such design or machine in the Hawaiian Islands. All communications should be addressed to the secretary of the Association at Honolulu. In order to enable inventors to gain some idea of the practical nature of this problem, we have secured some photographs taken specially to show the conditions which prevail in sugar cane plantations in the islands. The photographs are taken on an irrigated estate, and the figures may be considered as the average.

The canes grow in furrows, 30 feet long and 5 feet apart, center to center. They follow the land contour, and for this reason are sometimes straight and very often curved. At the end of each 30-foot furrow is a water-course 18 inches wide, which supplies one set of furrows. These water-courses are from 50 feet to

several hundred feet in length, depending upon the contour of the land. They draw their supply of water from what are termed "level ditches," so called because of their very slight flow. They are from 4 to 5 feet wide and 1½ feet deep, and run through the fields at convenient distances to supply the water-courses. For the operation of any reaper these ditches would be temporarily bridged.

From the furrow-bottoms the canes emerge irregularly. They range in number from 100 to 160 canes per 30-foot furrow, and when ripe are from 14 feet

furrows, provided their growth be in that direction. The top to be removed consists of a portion of soft cane low in saccharine matter, of green leaves attached at their bases to the stalk, and of unformed leaves in process of growth. Any reaper must of necessity cut canes off where they emerge from the soil and cut off tops in a satisfactory manner.

Concerning the loading device, the illustrations show the condition of the canes. The canes when cut are laid upon the field on top of the loose leaves and tops. This mat of leaves is several inches thick. Canes are cut in lengths about 5 feet long. As far as possible, they are laid straight; owing, however, to the curving of cane stalks, they are frequently laid irregularly. Portable tracks are placed in the fields, running generally parallel to one another, from 150 to 250 feet apart. Cars are run on these tracks in trains of about forty in number, and placed to suit. The car bottom is 2 feet from the ground; its length is 11 feet, and breadth 6 feet. It is assumed that canes on the ground will have to be placed on the conveyor of loader by hand. Any machine for cutting or loading should be operated by either horse power, gasoline, or electricity. Any engine deriving its power from coal or wood, which would either drop cinders or throw sparks, cannot be used in a cane field.

The quantity of cane loaded per day at this particular plantation averages 1,150 tons. For season of 1902 this will be doubled. From this it will be gathered that competitors should design substantial machines, capable of handling cane in large quantities.

It is hoped that American inventors will not be backward in devising an acceptable reaper and loader. We already lead the world in agricultural machinery, and we shall probably continue to do so.

The Becquerel Rays.

A new technical journal, Kirchhoff's Technische Blätter, to be issued within a few days, will contain an interesting article concerning the latest rays.

In 1895, a French chemist discovered rays emanating from the element uranium, which possessed properties similar to the Roentgen rays. They were called Becquerel rays, after their discoverer. But while the discovery of Roentgen aroused great interest in the whole civilized world, leading to radical changes in medical diagnosis, the Becquerel rays were only employed in a very limited way in physical laboratories, and an assertion by the French scientist, Demarcays, that they were not emitted from uranium, but from a new element, made no impression.

Recent experiments by the Berlin High School of Technology have proven this assertion—that a new element is responsible

for the Becquerel rays—and the interesting fact has been observed that these rays render almost every transparent substance luminous in the darkness.

These rays make it possible to tell genuine diamonds from artificial ones in the dark. This will prove of great practical importance in testing. The experiments have also resulted in obtaining, for the first time, larger quantities of the new element, which has demonstrated that rays emanating from a larger quantity make the air such a conductor of electricity that it is hoped this property can be utilized in wireless telegraphy. Experiments for this purpose are being made in the Berlin institution, but the deepest secrecy

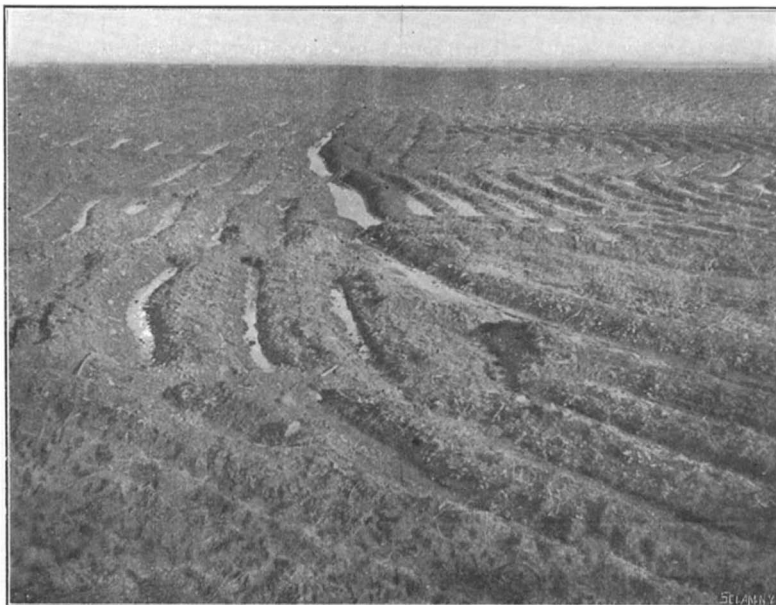

SUGAR CANE FIELD JUST PLANTED, SHOWING FURROWS AND WATERCOURSES.



CANE CUTTERS AT WORK ALONG LINE CUT OUT FOR TRACK.

to 20 feet long, with an average stalk diameter of 1.60 inches. The weight of cut cane runs from 70 tons to 105 tons per acre, with an average of 86 tons. They contain 11 per cent to 12 per cent of fiber.

The canes do not stand upright. Owing to their own weight, they lie along the ground for three-fourths of their length, with a perpendicular upturn for the remaining fourth, surmounted by the green leaves, or "top." After emerging from the soil, they reach out in all directions, forming a sort of mat of interlacing canes below these fairly upright tops. It will, therefore, be noticed that, with furrows 5 feet apart, the canes of above lengths will lie across two



A TRAIN OF CARS ALMOST LOADED.



LOADING CARS ON THE TEMPORARY TRACK.

is maintained concerning them. It is stated that the results will soon be laid before the Emperor, which seems to indicate that the discovery is regarded as one of great importance.

TRAINING SCHOOL FOR NEW YORK STREET-CAR MOTORMEN.

To the man in the street, the running of a 38-foot electric car of the underground conduit system, at a fairly high rate of speed, through the most crowded and busy streets of the world, is a matter which involves merely the turning of a controller-handle and of a brake-lever in obedience to the signals given by the conductor. But the man on the car is chosen, not because his work is apparently so simple, but because he has proved his fitness to hold his position by an arduous preliminary training. The heavy cars of our large cities cannot be controlled unless the starting apparatus be properly manipulated, unless the brakes are operated in a certain way, and cannot be safely driven through an interminable stream of wagons unless the motormen have no inconsiderable presence of mind and reasonably good judgment.

In order to train its men to think and act with coolness and precision, the Metropolitan Street Railway Company established a training-school some two years ago, in which ambitious recruits were to be systematically taught how to become not only acceptable motormen, but also fairly good electricians, thoroughly familiar with the mechanical and electrical construction of an electric car. The school was the first of its kind ever founded. When it was started by President Vreeland it was scoffed at; but the best proof of its success is to be found in the fact that the street railway-companies of the largest cities have followed the example of the New York company.

Before he is admitted to this training-school, the applicant is examined by a physician. If his eyes be weak, or if he be not sufficiently robust, he never even sees the training-school. The applicant who has successfully passed the physical examination is admitted to the school, and is assigned to one of thirty dummy car-platforms, disposed around the classroom, each fitted with a controller, a brake, a ground-switch, and a fuse-box. He is given a book of rules—his electric-car gospel—which he must learn as thoroughly as he once learned his forgotten catechism and the Ten Commandments. The breaking of one of these rules is a sin for which almost any punishment may be meted out. But, of all offenses, the most heinous is the neglect to remove the handles of the controller upon leaving the car. "Never leave the car-platform for an instant without removing the handles of the controller," is so thoroughly and persistently drilled into the embryo motorman's ears that the rule is followed in the end almost instinctively. Even the men who are tolerated in the school merely because they will not be convinced of their unfitness, never leave the dummy-platform with the controller-handles in place, although as a ruse they may be called by the instructor to his desk to receive some paltry information.

During the few days passed on the dummy platform, the motorman is taught how to start his imaginary car without hurling the passengers from their seats, and how to stop gradually under ordinary circumstances, and suddenly in a case of emergency. The advisability of turning the controller-handle one contact-point at a time, so that the power is applied gradually, is forcibly impressed upon him. In order that he may obey the signals of the conductor, the school-master conveys his orders largely by means of an ordinary car-bell.

When he has learnt the rudiments of his calling, the pupil is taught something of the mysteries of electricity. He is taken to the classroom controller, the casing of which is open, so that all who have eyes may see how it is constructed, and the meaning of each contact-point, each resistance, is clearly explained. He is taught how to cut out the disabled motor of a car from the controller, and how to manipulate the reversing-lever. The terms "multiple" and "series" are defined not only in unmistakable words, but objectively by means of the controller and the motors.

For this purpose the classroom is equipped with an operative skeleton-car, jacked up from the floor so that its wheels may spin with even more freedom than they would on the road. At this period the motorman enters upon the most difficult part of his education. On the road he must be able not only to run his car in a manner which will be a credit to his teaching, but he must also be able to locate open circuits whenever occasion may require. Accidents of all kinds may happen, and the pupil must be able to cope with them before he is graduated. Each man in turn is placed on the platform of the skeleton-car, is instructed practically how to operate the apparatus of which he has charge, and how to locate open circuits on a "dead" car, as it is called in road parlance. If, after having been brought to a stop, the car refuses to move when the current is turned on, the motorman knows that something must be amiss. In accordance with the teaching of the instructor, he

orders the conductor—usually another pupil—to switch on the lights. When the glow within the car shows that current is at hand, the motorman steps from his platform and examines the overhead switches on both ends of the car, not, however, without removing his handles. Should the switch-handles be in proper position he inspects the fuse-boxes. If he finds that a fuse has been burnt out he proceeds to the ground-switches to cut off the current, then inserts a new fuse, replaces the ground-switches, mounts his platform again, and starts the car. But if the fuses be intact the motorman is instructed to cut out the motors in succession from the controller in order to ascertain which motor is defective. Should the lamps fail to light he examines the ground-switches. If they be properly set and the headway short, he knows that nothing can be done and that the following car must push him to the terminus. But if the headway be sufficient he continues his inspection. Entering the car he lifts a trap-door and examines the leads of the plow by which the current is fed to the motors. If the circuit be open at the regular connections the leads are replaced in position; but if they be properly connected, then the motorman knows that some injury has been sustained which he cannot repair and that his car must be pushed to the stable. This instruction in making repairs is accompanied by striking illustrations of the consequences of the motorman's breach of the inflexible rule which requires him never to leave the car-platform without removing the controller-handles. Either the instructor or an advanced pupil plays the part of an excitable, forgetful motorman—the man who, when he finds that his car will not start, leaves his controller-handle perhaps on the sixth or ninth point, frantically rushes off to renew a burnt fuse or turn a switch-handle to its proper position, and then suddenly finds himself standing alone with his car speeding away so rapidly that it cannot be easily overtaken.

When a car is disabled by an open circuit and the brakes fail to arrest the car, the motorman is instructed to pull the reversing-lever toward him and then to turn the controller-handle to the sixth point. Thus the motors are placed in multiple and converted into dynamos, sufficient power being generated to stop the car almost immediately. If an emergency stop be necessary, the brake is released, the power is reversed, the controller-handle turned to the first point, and sand applied to the rails. Should a fuse or automatic switch be blown out, the controller-handle is moved to the sixth or ninth point, whereby the car is stopped in the manner already described. The motorman must also learn that, when on a heavy grade, an open circuit requires his attention and that the brake fails to hold his car, he has only to turn the controller-handle to the sixth or ninth point to stop the car, the reversing being left in the forward position since the car is already traveling backward.

The skeleton-car is provided with the usual resistance panels, raised, however, so that they can be readily seen, and fitted with lamps which clearly indicate when the resistance is partially or entirely cut in or out of the circuit. By means of these resistance lamps, the controller, and wiring-charts, the men are taught that with the controller-handle on the first point, the 1,550-volt current furnished by the power-house passes through all the resistance; that on the second point, one-quarter of the resistance is cut out; that on the third point, one-half the resistance is cut out; and that finally when the fifth point is reached, the motors are running in series with all resistance out. The transition from the fifth to the sixth point connects the motors in multiple, the controller-handle passing over three unmarked transition points. The motorman is instructed to make this transition rapidly, so that the motors may sustain no injury from the change to multiple. On the first transition point one-quarter of the resistance is cut in; on the second transition point three-quarters of the resistance are in the circuit, the motors still being in series. On the third transition point, motor No. 2 is dropped out of the circuit. On the sixth point both motors are in multiple with three-quarters of the resistance in the circuit. On the seventh point one-half of the resistance is in the circuit; and on the ninth point, the resistance is out of the circuit, both motors running under full speed in multiple.

The training which the motorman receives on the skeleton-car is supplemented by lectures on the method of crossing avenues and streets through which other cars travel. For classroom demonstration two sets of channel-rails are used, separated any desired distance, to represent the breach in the underground conductor. The schoolmaster constantly reiterates the necessity of shutting off the power at the point indicated by long white marks on the road, and of "floating" across the break. The consequences of turning off the power without sufficient headway are shown by means of a plow used in connection with the channel-rails.

When the applicant has learnt in the school all that he need know, he must pass through a post-graduate

course on the road under the guidance of an expert motorman before he is permitted to don the blue uniform which is his diploma, and to mount the platform of his own car. If the road practice prove that he has not fully grasped all that the instructor has impressed upon him, he is either sent back to the classroom, provided there is still hope for him, or summarily dismissed without ever entering the service of the company. The road is the crucial test which the training-school graduate must withstand. There all his faults and all his virtues glaringly exposed are carefully observed by the chief instructor; and there the electric-car career of many an applicant ends.

Our article has been confined to the training of the electric-car motorman. But the school is also equipped with the dummy platform of an air-motor car, and with a cable-grip. The air-motor car is controlled with more difficulty than a locomotive; and for that reason not more than ten per cent of the training school pupils are capable of manipulating its complex starting apparatus. Nowadays the cable-car grip is rarely used. In ten or fifteen years the tall model which now stands in the classroom and towers above everything else will be a relic of the bygone days of the cable-car—an interesting, antique curiosity.

Automobile News.

A long trip through Algeria has been lately made by Messrs. Joseph and Pierre de Crawhez, two prominent chauffeurs. Starting from Algiers, they proceeded toward the south, passing through Boghari, Djelfa and Laghouat, then returning by way of Bou-Saada and Aumale. The distance covered on the tour is about 850 miles, in a region where the roads are but little more than footpaths. The machines were an object of curiosity to the natives, as well as to the Europeans, who saw an automobile visit their region for the first time.

Some additional information has been received as to the operation of electric omnibuses in Berlin. An omnibus line has been lately put in operation to connect the Stettin and Anhalt depots. The Siemens & Halske vehicle with which the company has been making experiments during the last year has proved satisfactory. This omnibus has 12 places interior and 6 on the rear platform. The battery of 44 Pollak elements is placed under the seats and is sufficient for a 10 to 12 mile run. The present line is about 2½ miles long and the trip is made in 25 minutes. The fare for the whole distance is 2½ cents. Each omnibus makes about 60 miles per day; the route has some rather steep grades, reaching 7 per cent. At each end of the line is a central station for charging the batteries. The new system is said to work well and there is some talk of establishing other omnibus lines in different parts of the city.

The annual automobile race, organized by the St. Petersburg Club, had to be abandoned on account of a heavy snowfall, and postponed till a later date. The race was fixed for the 17th of February, and seven competitors were engaged, Messrs. Mazi, Barkett, Henrik and Loginoff in large machines and Sourmetz, Kroupscky and Alexieff in motorcycles. The prize was a challenge cup. The day before the race the thermometer marked 18 degrees below zero (Centigrade), and thick whirlwinds of snow filled the air. Four of the competitors declined to run; the other three left the next morning by railroad for Alexandrovskaya, on the Warsaw line, from which the start was to be made. Upon arriving the starter made a tour in his machine and decided that the snow was too deep to permit of running. The jury, composed of Dr. Klimenko, secretary of the club, and two other members, then declared the race off.

The Automobile Club of America now has clubrooms adjacent to Central Park, and a fine library and grill room are provided. The Board of Governors has issued a resolution asking all members to regard the speed regulations. They strongly disapprove of an excessive rate of speed on the public highways, in disregard of the comfort and safety of other users of the common roads, as an injury to the sport and to a great industry. They expect that when members driving automobiles meet a driver of a horse or horses which are restive or frightened, the automobilists, on request or a signal from such driver, will in all cases stop and use every precaution to avoid the possibility of an accident. Any member of the club who shall be found, after a fair hearing, to be guilty of driving at a dangerous or excessive speed on the public highway, or who has disregarded the comfort and safety of other users of the same by failure to stop when requested by the drivers of frightened horses, or who has been guilty of such conduct in the use of automobiles on the highways as shall tend to bring odium or reproach on the organization, shall be duly warned and suspended, and upon the repetition of such offense, shall be expelled from the club. This step taken by the Automobile Club of America will win respect for the organization, which has always done everything in its power to help, not only the sport, but the motor industry as well.

Correspondence.

The 7-inch vs. the 6-inch Gun.

To the Editor of the SCIENTIFIC AMERICAN:

I have followed with interest the controversy now in progress in your paper concerning the armament for the cruisers of the "California" class. It is most satisfactory to know that there are people who take such deep interest in the development of our navy as do your correspondents. It is well that our people take an active interest in such matters, and that their opinions be brought forth. While some very good points are raised on both sides of the question, erroneous ideas are apt to appear. It is to such an idea that I wish to call attention, not for mere argument's sake, but in the hope that its correction may lead to further discussion of the subject in question on a more comprehensive basis.

I refer to the communication in your issue of March 23, 1901, in which your correspondent suggests the substitution of 7-inch for the 6-inch rapid-firing guns as a means of solving the battery question of the "California" class of armored cruisers. That would be a great mistake; for there would be no gun of intermediate caliber between the 7-inch and the 3-inch (14-pounder) guns. Moreover, if an intermediate caliber could be introduced the difference in efficiency between the 7-inch and the 8-inch would not warrant the installation of the two on the same ship. In fact, it would be considered a very unwise policy to have two so closely related guns on one ship, be they 4-inch and 5-inch, or 6-inch and 7-inch. The 6-inch (100-pounder) is a very good "stepping stone" between the 8-inch (250-pounder) and the 3-inch (14-pounder).

One of the lessons of the Spanish war has evidently escaped the consideration of your correspondent, and that is the moral effect of rapid fire upon an enemy. What overwhelmed the Spanish gunners was not the accuracy of our fire, far from it—only from two to three per cent of the shots having taken effect; it was the rapidity of our fire that filled the air with shell that demoralized them.

It is safe to assume that the latest 6-inch gun will be able to deliver more metal within a time limit than the 7-inch gun, and with the same, probably superior, accuracy due to its more manageable size; for the smaller the caliber the greater the rapidity of fire. If the 7-inch gun were adopted, as proposed, the 8-inch gun and the 6-inch gun would have to be discarded and the 5-inch gun brought into play to fill in the gap between the 7-inch and the 3-inch guns, and that is not as effective for all-around work as the 6-inch gun against the latest ships.

The following also attracted my attention while reading the correspondence referred to, viz.:

"If fighting is the primary object of a warship, it would certainly seem that her offensive power should not be made of secondary importance to other qualities in her make-up."

According to that let us take our "Californias" and remodel them so that the machinery is reduced to ten or twelve knots efficiency, the coal capacity to about 500 tons, the high freeboard of some twenty feet to the low one of a foot and a half or two, and reduce everything else that we do not actually use in fighting. The result would be a monitor—an excellent fighting ship, but of what strategic value? Surely a monitor with four 8-inch, fourteen 6-inch, eighteen 4-pounders and twelve 3-pounders and four 1-pounder guns would be a most formidable fighting vessel, even more formidable than the "California" of the same armament before being changed. Anchor them both within fighting range and let them bang away at each other. The result would be the cruiser much the worse for the experience, due to her greater exposed surface; for her high freeboard would serve as a short stop for many shots. If, however, the cruiser be permitted to use her superior speed she would be able to accept or refuse battle. If accepting battle her speed would serve her for constant maneuvering which the slow speed of the monitor could not offset. But give your monitor speed, hence greater coal capacity, hence a greater crew, hence greater freeboard, hence greater displacement, and you have a rival for the cruiser on an equal standing. Thus it will be seen that a ship, to be an all-around fighting ship, must combine such qualities as belong to vessels of another class—the protected cruiser or even the gunboat, which are strategically excellent but offensively poor.

It seems that for all-around efficiency the "California" and class are first-class ships and I am sure that they are the result of conscientious work on the part of our naval constructors, to whose benefit it is to produce only first-class work.

CARLOS DE ZAFRA.

118 West 44th Street, New York, N. Y.

The great Serpent Mound in Ohio has been transferred to the Ohio Archaeological and Historical Society.

Engineering Notes.

The Cape-to-Cairo railroad is now in operation to a point 100 miles beyond the southern line of Lake Tanganyika.

The company making cellulose for war vessels, explosives, etc., now has three large factories in successful operation, besides two cutting plants. A fourth factory is nearly completed.

The French art critic, M. Arsène Alexandre, has discovered that our machinery showed a distinct beauty of racial type. The national character was clearly marked, he thinks, even in our locomotives. This theory is an ingenious one, and is worthy of elaboration.

A scheme is on foot to start a fast line of steamers on the Thames between Kew and Woolwich. Certainly there is no river in the world that needs fast service of boats as the Thames. The boats which run to Hampton Court make phenomenally slow time. They are retarded by the locks.

The sizes of anthracite coal and the screens through which they are made are as follows, says Steam Engineering: Coal which runs through a screen having a mesh of 3-16 of an inch is called barley; $\frac{3}{8}$, rice; 9-16, buckwheat; $\frac{7}{8}$, pea; $1\frac{1}{2}$, chestnut; 2, stove; $2\frac{3}{4}$, egg; $4\frac{1}{2}$, grate; 7, steam. Coal beyond this size is known as lump coal. Bituminous lump coal passes over bars $1\frac{1}{2}$ inches apart; bituminous nut coal passes through bars $1\frac{1}{2}$ inches apart; slack coal passes through bars $\frac{3}{4}$ of an inch apart.

Germany offers abundant market for a large number of American commodities, especially in the way of office furniture and supplies. The safes are mostly of obsolete types with old-style locks, and judicious efforts on the part of our manufacturers would result in large sales of our medium styles store and office safes. German offices and stores are rapidly adopting modern furniture including desks, typewriters, file cases, cash-registers, etc., and safes will prove equally as popular. Heidelberg students carry ink in bottles to and from classes and, indeed, the fountain-pen seems to be very little known in Germany.

In December a serious country fire occurred along the line of the Great Southern Railway in the Argentine. It extended 60 miles, and burned some freight rolling stock as well as telegraph poles and fence posts. The fire appears to have been spread by the great amount of "paja voladora," or flying grass. It is blown about by the wind and whatever care the railroad companies may take naturally they cannot keep it off their right of way so long as it exists. It is difficult for the trains to cut their way through it, and it causes hot boxes and even derailments, while foremost of all is the terrible danger of its taking fire. The shifting of the wind a few points after the section hands have cleared the track of the flying grass may result in its immediately being buried in the dangerous stuff again.

Vauluse, in South France, is a center of the ocher industry. Sometimes the ocher is excavated direct without mining, but often shafts are sunk. The material when brought to the surface is transported to the valley below on carts and is then washed. Mining is only done in the winter season, as the watercourses are dry in summer. By means of successive settling basins various degrees of fineness are secured in washing the ore. At the end of the winter these basins are filled with ocher in the form of mud, which dries hard during the heated term, and is then cut into blocks of regular size and dried in the sun. It is then either cut into blocks or crushed into powder for shipment and is sorted for color; the yellow shades command the highest price. The total production of these mines last year was about 180,000 tons, and of this amount 3,000 tons were shipped to the United States. Although the mines have been worked for many years they are not exhausted.

The London County Council have issued their annual report reviewing the work accomplished in the metropolis during 1899 concerning tramways, dwellings, and numerous other schemes which were carried out at an aggregate cost of more than \$56,250,000. Twenty-three miles of new thoroughfares were undertaken, which will result when completed in an increase in the population under the jurisdiction of the Council from its present 4,700,000 persons to 7,096,400 persons. The maintenance of the Fire Brigade cost \$1,000,000, while a similar sum was expended upon the drainage of the city. The present sewers are too small to cope with the rapidly-increasing exigencies of the population, and a new scheme for reconstructing the drainage system is being projected at a cost of \$15,000,000. London possesses 3,809 acres of open spaces and parks, to maintain which cost \$572,575. In 1889 the cost in this direction was only \$263,755. The Council also maintains the coroners' courts and the asylums; is responsible for the highways, bridges and public health; controls the theaters and music halls; and attends to the enforcement of the Weights and Measures act, in which 1,100 offenses were punished during the year.

Electrical Notes.

The London United Tramways, upon which electric traction has been introduced in place of horses, are meeting with considerable opposition from the scientists of Kew Observatory. A section of the line passes within three-quarters of a mile of that building and the observers complain that their delicate instruments are deranged and the records spoiled by the near neighborhood of the electric current. The Board of Trade have the matter in hand, and experiments are to be carried out to ascertain to what the electrical disturbances at Kew will amount, and the best methods of insulation. The tramway engineers do not feel disposed to resort to elaborate and expensive means for insuring complete insulation, so that a complete deadlock is the result, and the tramways cannot yet be opened to public traffic.

The separation of wireless messages is now receiving great attention by electricians. M. P. Jégou has adopted a new system in which he employs mast-wires of different ranges. Four such mast-wires are employed, two at the sending station and two at the receiving station. Their heights are so arranged that one of them covers, say, a range of five miles, while the other does not. The circuits of the coherers attached to the two mast-wires are so arranged that their simultaneous action produces no effect upon the galvanometer, but at a distance of five miles the galvanometer will respond to a message from the sending stations addressed to both coherers, as only one of them is brought into action. At half the distance when both coherers are within range no effect is produced on the galvanometer.

There is a project on foot for the construction of a movable electric platform on the right bank of the Seine. It will be underground and its length will be about six miles. The route proposed passes under the Avenue de l'Opera, the great boulevards, Boulevard Sebastopol, the Rue Turbigo and the Rue de Rivoli. The new scheme calls for four platforms instead of three as was in use at the Exposition. The first platform will be stationary, the second will have a velocity of $1\frac{1}{2}$ meters a second, the third 3 meters and the fourth 5 meters or $16\frac{1}{4}$ feet. This will enable pedestrians to have a very rapid means of transit afoot, in a portion of Paris which is greatly encumbered by vehicular traffic, for as all the locomotion is in one direction persons can walk very fast on the fourth platform, and will be able to cover a great distance. Some means of transit on the streets mentioned is so necessary that it is very likely the scheme will be carried into effect.

Attempts are being made by the Marconi Wireless Telephone Company, of London, to inaugurate a wireless telegraph service to Australia. Although the total distance is considerably in excess of that from England to this country, it can be more easily negotiated owing to the facilities offered at various points en route, for the installation of subsidiary transmitting stations. Arrangements are being made to erect stations at Prawl Point, the Lizard, Ushant, Cape Finisterre, Gibraltar, Malta, Algiers, Sardinia, Sicily, Cape Malea in Greece, Alexandria, Aden, Socotra, Colombo, Sumatra, the Cocos Islands, Perth, Albany, Adelaide, and Melbourne. The various governments of the countries in which these points are situated are being approached to obtain permission to install the stations. In no single instance is the span between two points so great as that from the west of Ireland to New York, so that, if success attends the experiments in this case, it will probably be equally possible to extend the distance and to establish ether communication between this country and Great Britain. If the vessels plying between England and the Antipodes are supplied with instruments, it will be possible for passengers to dispatch and receive messages during the voyage.

A new process for making plates of porous lead for use in accumulators or for acid filters has lately been patented in Germany by Richard Bauer. In place of treating the melted lead by a jet of gas or vapor, as is often done, the inventor uses a material which by contact with the melted metal is volatilized and penetrates through the mass during the cooling. Sulphur is best adapted for this purpose; it has the property of combining with the lead to form sulphide, and this sulphide when decomposed by dilute hydrochloric acid leaves a mass of porous lead. In practice the operation is carried out as follows: The two halves of a plate mould are heated and a small quantity of melted sulphur is introduced, so that after cooling the sides of the mould are covered with a layer of sulphur. The lead, heated to redness, is then poured into the mould; the sulphur is vaporized and penetrates into the mass. After cooling, the plate taken from the mould is composed of lead, sulphide of lead and an excess of sulphur. The latter is removed by a preliminary washing and the plate is then treated with dilute sulphuric acid, which decomposes the sulphide and leaves a plate of pure lead which is extremely porous and well adapted for accumulators and other uses.

THE OMNIGRAPH—AN INSTRUMENT FOR TEACHING TELEGRAPHY.

Old telegraph operators will still remember how messages were once received on a tape driven by a clock train. The skill acquired soon rendered it possible to dispense with the tape and to translate the message directly from the sounder. But the acquisition of that skill came only with long practice; for which reason the modern novice must spend hours and hours before the ticking of a sounder becomes instantly intelligible to him. An instrument which is designed to simplify instruction in telegraphy, and to impart in a comparatively short time a complete knowledge of the Morse alphabet, has recently been introduced by the Omnigraph Manufacturing Company, of 39 Cortlandt Street, New York city. Patents have been applied for.

The Omnigraph, as the instrument is called, consists of a baseboard on which are secured an ordinary key and sounder, between which a disk is mounted, formed on its periphery with teeth. A spring contact adjacent to the wheel engages the peripheral teeth of the disk. Although irregular, the arrangement of the teeth is arbitrary. For if the disk be rotated by means of a small crank-shaft geared with the disk-shaft, the spring contact is forced outwardly by the teeth, but drops back by its own elasticity, and thus makes and breaks the circuit. The experienced telegraph operator detecting these makes and breaks at the sounder, recognizes them as the dots and dashes of the Morse alphabet. A close inspection of the disk would reveal to him that the teeth are so arranged as to spell the sentence, "John quickly extemporized five tow bags." If the disk be rotated forwardly, this sentence, thus oddly worded to include every letter in the alphabet, is ticked off at the sounder; if rotated in the opposite direction, the sentence will be telegraphed backward.

The disk is completely under the control of the student. It can be rotated as slowly as desired; or it can be so rapidly turned that its curious sentence will be received at the sounder with a speed that would open the eyes of a good operator. Moreover, the message on the disk is transmitted with a distinctness and faultlessness which

the letter to be transmitted cannot possibly be anticipated. Thus the student learns how to receive a cipher message, the meaning of which he cannot know.

When sufficient proficiency has been obtained in receiving messages from the sounder, the student can learn to transmit messages in the regular method by

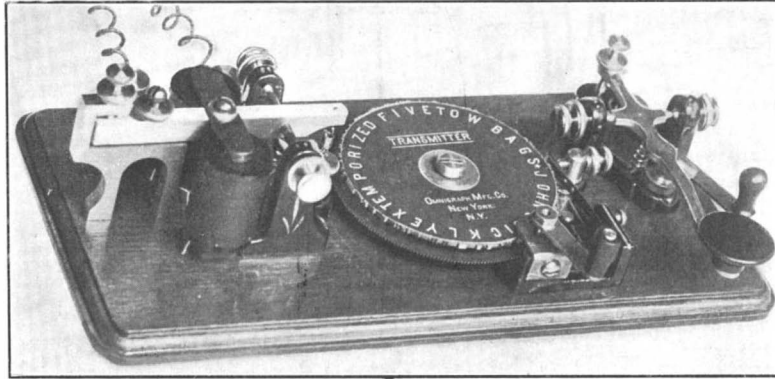

THE OMNIGRAPH.

means of the key which forms part of the apparatus.

HYDRAULIC ELECTRIC-CAR BRAKE.

The extraordinary development of city and suburban electric car service is making the question of a proper control of the cars of increasing importance. Not only is the average running speed increasing, but the headway between cars is growing less. Coupled with the growing number of cars and the higher speed, there is the fact that traffic is becoming denser, all of which conditions render it imperative that the cars should be provided with a brake system which will be powerful, and instantaneous in its application, and safe-guarded against any possibility of failure at the critical moment. Although many forms of mechanically-operated brakes, showing more or less ingenuity, have been devised, it is a fact that a great majority of the cars are still

the other a sectional view, showing what is known as the Neal-Duplex brake, which is operated on the hydraulic principle, and has the advantage of being applicable to any standard car, and of being operated by the same brake handle to which the ordinary chain-brake is attached, and available for use at any time. The device consists essentially of a pump carried upon and operated from the axle, and a hydraulic-brake cylinder, which is fastened to the bottom of the car and supplied directly from the pump with a non-freezable oil under hydraulic pressure.

The oil reservoir, with the pump and its valves, is contained in a casting which is made, for convenience, in three separate sections, which are bolted together, and completely shut in the working parts to the exclusion of all dust and dirt. It incloses and is carried directly upon the axle, the escape of oil being prevented by means of stuffing boxes, one of which is clearly seen in the perspective view.

The pump piston, *P*, is driven by means of an eccentric, *B*, which is mounted on the axle, and, of course, is in constant operation when the car is running. The brake cylinder, *D*, contains two pistons, whose piston rods, *E* and *F*, projecting through opposite ends of the cylinder, are connected directly with the ordinary brake levers, *G*. This cylinder is provided with a piston valve, *H*, which is connected directly through the rod, *I*, with an eccentric, *K*, carried on the lower end of the brake-staff, the turning of the brake-handle from a quarter to a third of a revolution by the motorman serving to open or close this valve. The brake cylinder is connected with the pump by means of two pieces of steel hose, *M* and *L*. Normally, when the brake is not in operation, the piston valve in the brake cylinder remains open, and the oil is driven through the hose, *M*, to the brake cylinder and thence back to the suction pump valves, the flow of oil being continuous and perfectly free. By a quarter turn of the brake-

handle, however, the piston valve is closed and the full hydraulic pressure of oil is exerted upon the pistons of the brake cylinder, driving them to the center of the cylinder, as indicated by the arrows, and thereby setting the brake shoes. When the piston is opened by the motorman the free circula-

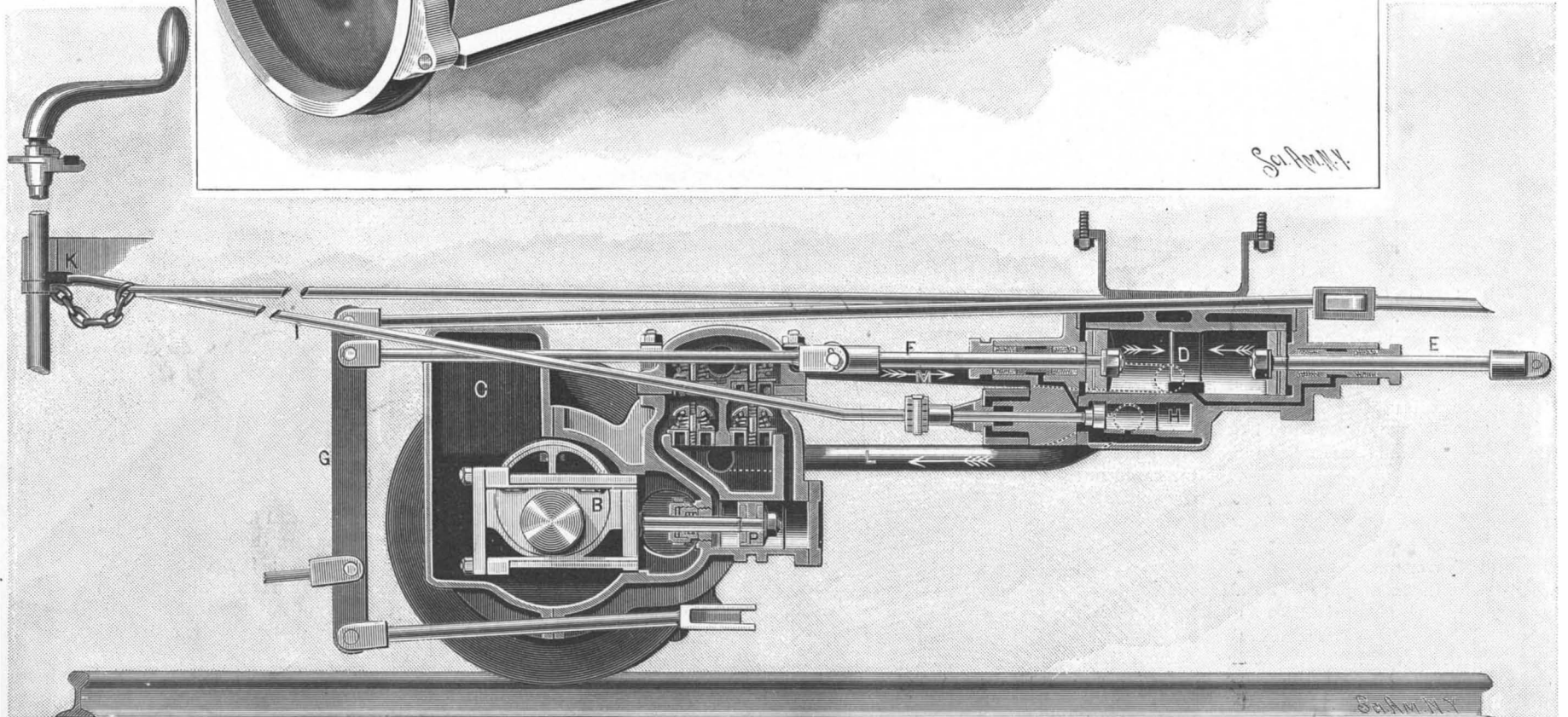
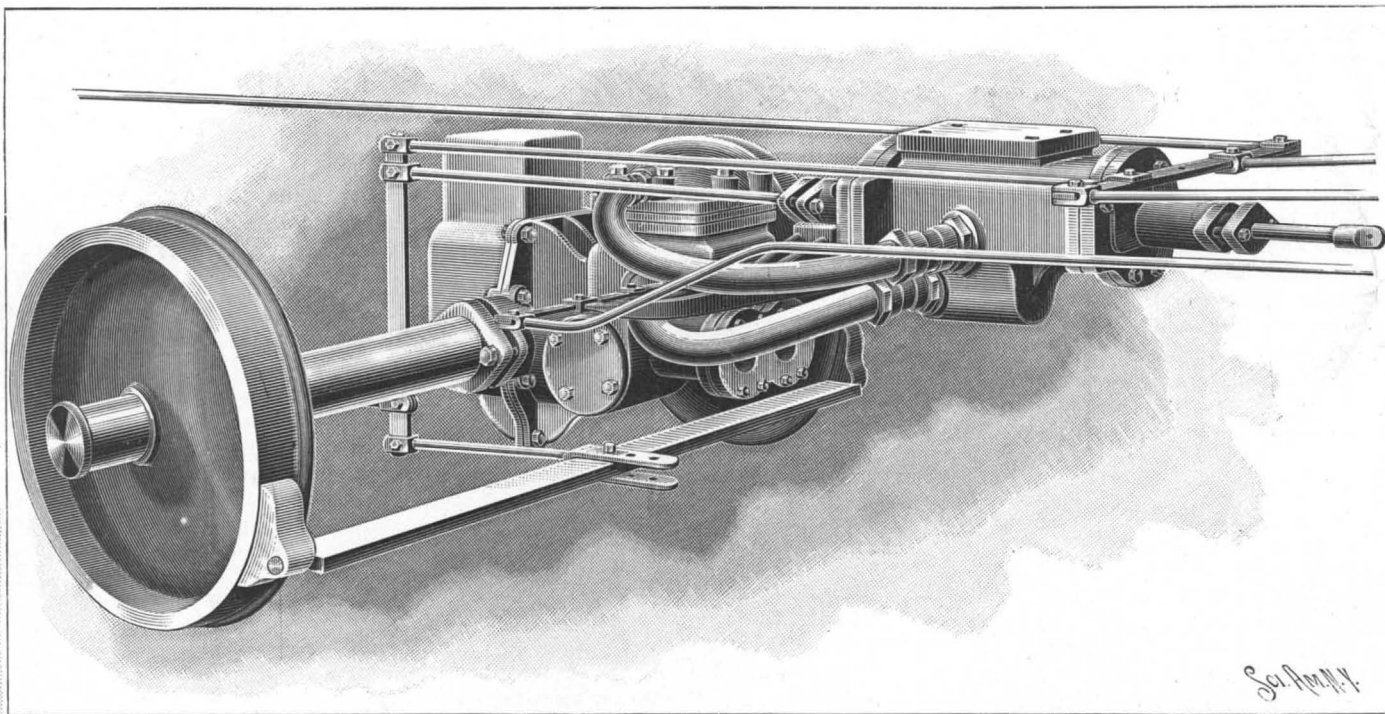

HYDRAULIC ELECTRIC-CAR BRAKE.

the most perfect operator can never hope to attain. At first blush it might seem that the student simply learns one sentence forward and backward, and that the instrument is a good teacher only within very narrow limits. But this disk can be partially rotated forward and backward any number of times, in any place, so that

controlled by the old hand-brake; and while this is fairly efficient, it has the drawback of being slow in its application, whereas in cases of emergency, the gain of a fraction of a second in the action of the brake may be of the most vital importance.

We present two engravings, one a perspective and

tion of oil takes place as before. This brake, which was invented by J. H. Neal, and is manufactured by the United States Steel Company, 145 Oliver Street, Boston, Mass., is the outcome of considerable experience in the operation of the Boston Elevated Railway Company's system, and it has many advantages

which have been proved by the test of actual service. In the first place, it is instantaneous in its action, the brake being set, as we have said, by a quarter turn of the brake handle, and the appreciable delay which occurs in the winding up of an ordinary hand-operated chain-brake avoided. Another most important advantage, which will be appreciated by the repair shop, is that the actual locking or "skidding" of the wheels is impossible, the brake being under automatic control; for should the wheel, and, therefore, the pump, stop, the pressure on the brake cylinder piston heads is lowered, and the braking effect removed. At the same time the motorman has at command the full efficiency of the ordinary chain-brake. The mechanism is adjustable to any brake that allows 6 inches or more of axle space. Its total weight is less than 500 pounds, and the cost of power for its operation is, practically, nothing at all. The whole brake being carried in an air-tight casing filled with oil, the mechanism is self-lubricating, and repairs, as proved by actual operation, are very light.

A REMARKABLE SALT DEPOSIT.

BY CHARLES F. HOLDER.

Few readers of the SCIENTIFIC AMERICAN had heard of the Sea of Salton up to 1892. At this time the Colorado River broke its barriers and flowed into the desert of California, flooding it to an extent of hundreds of square miles. In the vicinity of Salton was one of the largest salt deposits in America; the water encroached upon it, and for a time threatened the industry, but after creating an excitement which spread over the entire West, it receded. The rumor was to the effect that the new sea was so vast that it would change the climate of Southern California.

The deposit of salt at Salton is one of the sights of California. It lies in a depression almost three hundred feet below the sea level, and was at some time in the past the bed of a sea, or extension of the Gulf of California. From the train, which passes nearby, the tract looks like a vast snow field, and in the early morning is frequently the scene of beautiful mirage effects. The salt deposit, which is essentially rock salt, covers about one thousand acres, and is at present the center of interest on account of the dispute of rival companies over the possession of the property. The company in possession has shipped from this place annually about two thousand tons of salt, valued at from \$6 to \$34 per ton, according to quality. The outfit of the salt mine consists mainly of a crusher, a drying building, and a dummy line from the salt beds to the Southern Pacific Railroad, not far distant. The work is carried on mainly by Indians, who can withstand the intense heat of the desert—150 deg. in June—and the glare better than white men. The work is interesting and novel. The drying house is a building six hundred feet in length, about which hundreds of thousands of tons of salt are heaped, having all the appearance of snow. Here the salt is dried and milled. The salt is collected at first with a plow—a singular machine with four wheels, in the center of which sits an Indian guiding it; the motive power is a dummy engine some distance away, which hauls the plow along by cables. As it passes, the steel breaker is seen to cut a broad but shallow furrow, eight feet wide and three feet long, throwing up the ridges on either side. Indians now follow along, and with hoes pile up the salt in pyramidal forms, which later is transported to the mill. Each plow harvests seven hundred tons of salt per day. A singular feature of this bed is that the

salt is being deposited daily by springs which run into the basin, and as the water evaporates it leaves a crust of almost pure chloride of sodium, which ranges from ten to twenty inches in thickness, over the lake. It will be seen that there is no danger of exhausting the supply, which is forming all the time; and, in point of fact, the plows have in the past years worked almost continuously over the same area, only about ten acres having been plowed.

The salt, when delivered at the plant, is hoisted to the upper floor and placed in a bulkhead breaker,

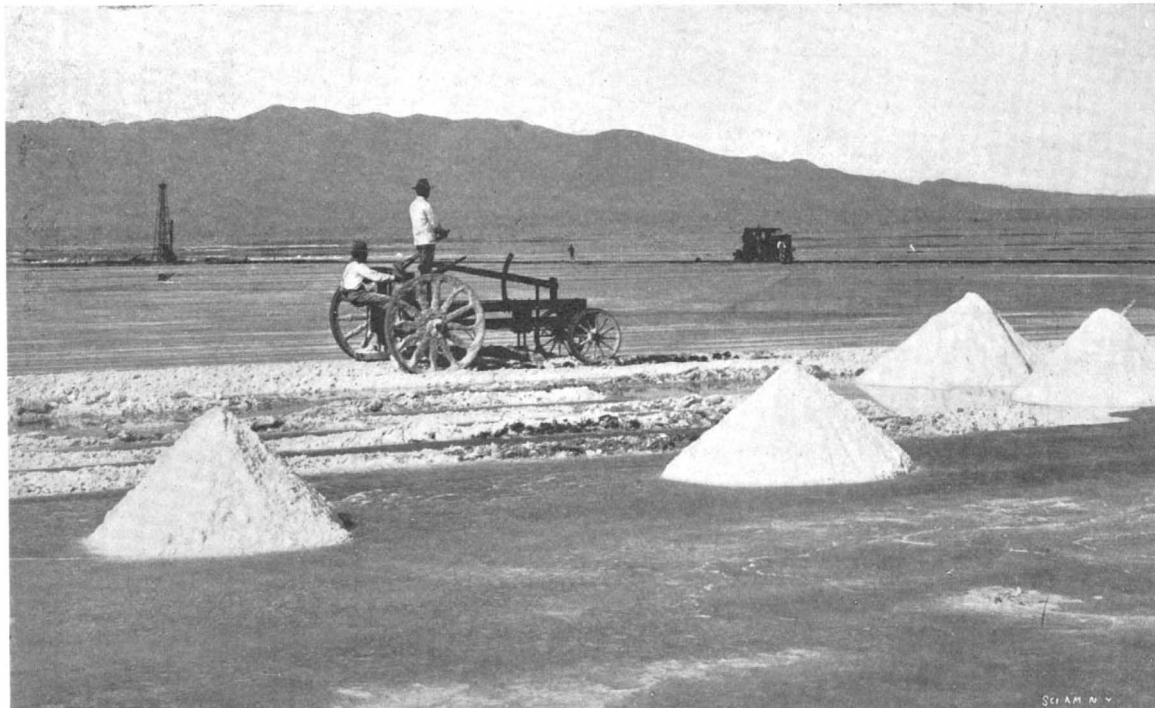

SALT DEPOSITS AT SALTON, CAL.—SIDE VIEW OF SALT PLOW.

where it is reduced to particles of the same size. It then passes through a burr mill and is well ground. After this it is sifted and is finally passed through an aspirator, which cleanses it of all foreign material, when it is ready for packing in bags. The salt is used for a variety of purposes, and is of several different grades, the lowest being unrefined—a product called hide salt, used in manufactories. Large quantities are sold for sea-bathing purposes, a certain amount producing a very similar chemical equivalent to sea water. Other grades are prepared for the table, dairy and for the use of druggists.

Copper Casting.

For some purposes, such as valve seating and the like, states Walter J. May, in *The Practical Engineer*, copper has considerable advantages, but there is usually some trouble in getting them sound; in fact,

At the same time, old sheet scrap, when carefully cleaned from tin and solder, gives very good castings, but the waste is greater, this often more than balancing the difference in price.

Having your copper, it should be melted in crucibles kept for copper only, and it is well to use the best non-sulphurous coke for melting. Gas coke holds too much sulphur to be useful, and some of the hard cokes are not to be recommended for the best work, as some of the impurities get into the metal at times. Clean melting is essential to obtaining good results, and must not be overlooked.

In preparing the moulds care must be taken to ram fairly hard, and to vent well, giving large runners, and, where required, risers, but the gates should be only of ordinary size as for iron. Thin sprues are not desirable, as it is policy to keep the connection between the runner and casting fluid until the latter has set, so that metal can keep drawing in until contraction ceases; in fact, the writer has found that a large head of metal and moderate feeding is of great assistance; therefore, in making moulds this should be provided for. The moulds should be coated—sleeked—over with plumbago, and dried, and, needless to say, the boxes should fit well. So far as possible a slight inclination from the pour-

ing gate should be allowed when setting the boxes for pouring; but due attention to the shape of the castings must be paid in arranging this part of the business. The metal should be poured hot, and the feeding rod should be kept at work longer than for iron, and the castings should not be opened out before they are black hot or even cold. In every case it will be necessary to flux the metal, and for this purpose either muriate of ammonia and chalk, well ground together in equal proportions, or roughly-crushed chloride of manganese, should be used, from 4 ounces to 12 ounces to the hundredweight of metal being necessary, according to local requirements; but the writer finds that either of these is effective. In applying these fluxes, they may only be put into the metal after it is melted, the best time being soon before the crucible is taken from the furnace, throwing the flux on the metal and well stirring in, not taking the crucible from the fire until the fumes have ceased. It is no earthly use putting chloride fluxes into the pot before the metal is melted, as you only destroy the pot and make a stink by so doing, without affecting the metal. You are not using glass or other hard material that has to be melted, it must be remembered, and if you want to obtain the due effect from any flux which you are using you must add it when it will be effective.

There is no reason why copper should not be cast as soundly as brass, although it needs more care, and copper can be hardened, if necessary, to the hardness of mild steel; but alone, copper would not make a good bearing metal. The small amount of manganese added in using the chloride mentioned above does not

seriously affect the copper, if it is of good quality to start with.

The difference between the specific heats of cobalt and nickel increases as the temperature rises. According to the results obtained by Pionchon the specific heat of nickel is at first a little greater than that of cobalt, and becomes very much less at higher temperatures. The electrical conductivity is very different for the two metals. Taking silver as 100, cobalt equals 17.22, and nickel 13.11.



PILING THE SALT AT SALTON, CAL.—280 FEET BELOW THE LEVEL OF THE SEA.

many brass-foundry people say that sound castings cannot be made in copper, and probably such has been their experience, using ordinary brass-foundry moulding and cheap brands of copper; but all the same for that, under proper conditions, copper can be cast as readily and as soundly as gun metal if you go the right way to work. In the first place, you require good metal, and probably you cannot do better than use good new sheet scrap, as this would give the highest grade of tough metal at a moderate price, and such metal as would probably give the best castings,

AN IMPROVED PIPE-WRENCH.

The illustration presented herewith pictures a novel pipe-wrench which has been recently patented by Charles M. Ingersoll, of Summit Hill, Penn. The wrench has a hollow body in which a rolling carrier is mounted. Through this carrier the threaded shank of the movable jaw of the wrench is passed. By means of a nut which encircles the shank, and which is fitted in the carrier, the movable jaw can be adjusted to grip pipes of various sizes. The fixed jaw is mounted at the lower front portion of the wrench, and is formed with

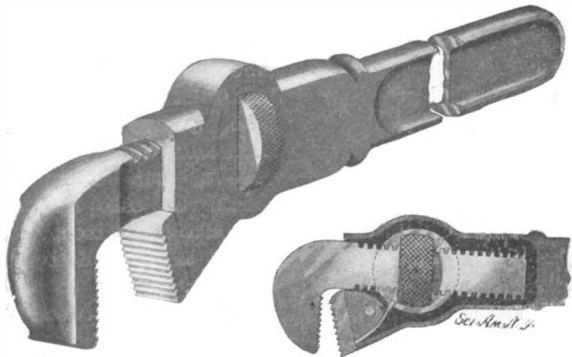
**THE INGERSOLL PIPE-WRENCH.**

a lug engaged by a transverse pin. By reason of this simple arrangement the fixed jaw is rigidly, though removably held in place. The fixed jaw presses against the end of a spring and holds it firmly in position. The free end of the spring is connected with and actuates the rolling carrier. The spring is so set that it tends to throw the inner end of the shank of the movable jaw upward, holding the shank and jaw, when not operating, in the position shown by the larger illustration.

By turning the wrench in the usual manner when a pipe is to be gripped, the oppositely-ratcheted faces of the jaws will engage the metal. When the working strain on the wrench is relaxed, and movement of the wrench reversed to recover the grip of the jaws on the pipe, the shank of the movable jaw is moved by the force of the spring so that its inner end is thrown up. Thus the jaw itself is pressed yieldingly against the pipe. The jaws, by reason of this arrangement, can be moved idly over the pipe to recover their grip; when the wrench is moved again to turn the pipe, the jaws are again brought into action.

It will be observed that, owing to the protrusion of the jaws, the wrench is enabled to turn a pipe close to a wall or ceiling.

A NEW WICKLESS OIL BURNER.

The possibility of generating from common kerosene or petroleum a gas equal in heating power to that obtained from the street mains of a large city is something that has long been desired. The difficulty has been that in heating oil to a vapor there is a certain proportion of carbon that adheres to the tubes through which the vapor passes, and in a short time the generator tubes are filled with this deposit and rendered useless. It is difficult to remove this pipe carbon, and this has been one of the reasons why the use of petroleum has met with little success.

But in the modern improved burners which have been introduced by the Hydrocarbon Burner Company, of 197 Fulton Street, New York city, which form the subject of the present article, the difficulty is very simply overcome. A novel cleaning device is now used, which answers all requirements and insures a steady flow of vapor.

The improved hydrocarbon burner consists of an oil-reservoir provided with an air-pump and with a filler-cap, on which reservoir a burner is supported by three standards. By means of the air-pump sufficient pressure is obtained to force the oil upwardly through a small tube into the vaporizing-tube extending horizontally above the burner. From the vaporizing-tube the vaporized oil passes into an air-tube curved downwardly and terminating beneath the burner. The vaporizing and air tubes are not directly connected, but are slightly separated so that the vapor, in bridging the space between the tubes, is mingled with sufficient air to give an intensely hot, blue flame. The vaporizing-tube is located above the burner, so that the oil may be converted into gas by the heat of the burner. In order to start the generation of gas, the vaporizing-tube is first heated by alcohol. As soon as the burner is ignited, vaporization proceeds automatically.

To control the flow of vapor from the vaporizing-

tube to the air-tube, a needle-valve is employed. And the particular formation of the stem of this needle-valve constitutes one of the most important features of the apparatus. For the stem in question is not merely a straight rod, but an auger, or screw, which permits the passage of oil, and also acts as a cleaner. A slight rotation of the valve causes the auger-like stem to remove from the entire interior wall of the vaporizing-tube the accumulation of carbonized matter. By this simple device, the tube can be readily cleaned whenever desired, and the regular flow of oil and gas at all times controlled.

The present device seems practical, and is said to be efficient in removing carbon from the tubes by the ordinary operation of the stove, at the same time keeping the exit opening for the vapor clear of obstructions. It has great power. The pump which forces the oil into the burner gives any reasonably strong power desired. By means of the needle-valve, the power can be so regulated that a flame can be obtained, varying from a consumption of 35 feet of gas per hour to 1 foot of gas per hour. This principle can be applied to a larger burner of greater power.

THE WENTWORTH COTTON-GIN.

Cotton-growers have ever been reluctant to cultivate long, fine staple cotton for the reason that the proper gin to separate the lint from the seed and to prevent the breaking and cutting of the fiber has never been invented. The objections to existing machines seem, however, to have been overcome by Mr. William H. Wentworth, of Fort Sam Houston, San Antonio, Texas, who is well known as the first successful grower of Egyptian cotton in America.

Mr. Wentworth's experience with the roller system of ginning taught him that the main disadvantages encountered were slowness or lack of capacity, and the impossibility of treating any but the long free ginning cottons. In the belief that our common cottons, if ginned in the roller process, would command better prices he associated himself with Mr. Otto Klaus, of the same town, and patented the gin which forms the subject of the accompanying illustration.

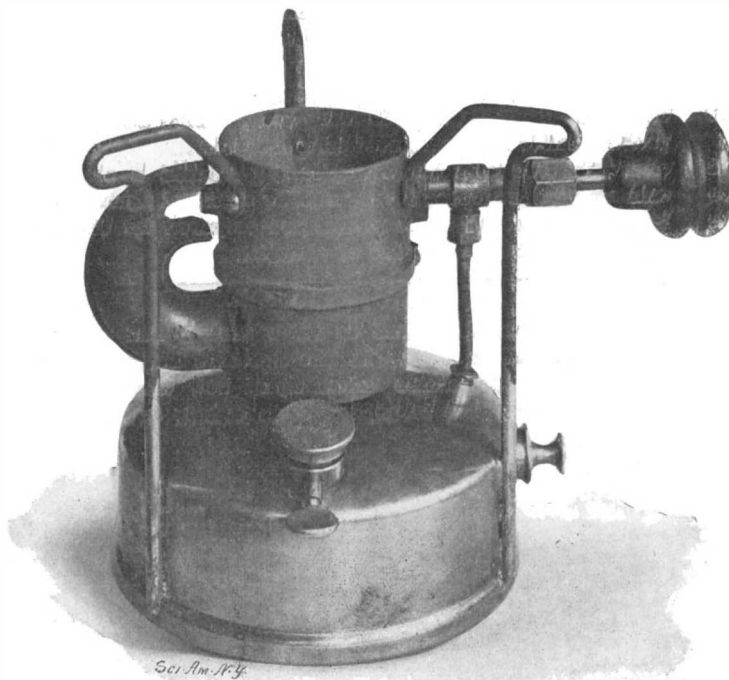
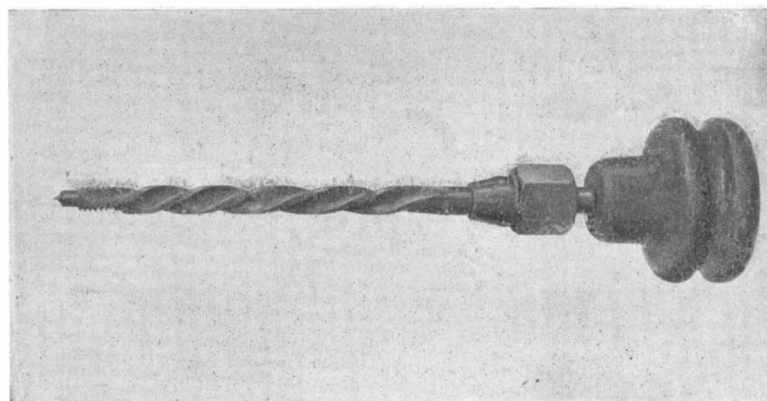
**AN IMPROVED HYDROCARBON BURNER.****THE NEEDLE-VALVE AND ITS AUGER-STEM.**

In the Wentworth machine the seed-cotton is fed through openings in the head of the gin-casing to a series of compartments each containing a ginning-roller covered with hide, the hair of which has been cut short. In each compartment are vertical feed-boards pivoted at their upper ends. Between the feed-boards and the rollers the seed-cotton falls, the feed-boards being reciprocated to force the seed-cotton to the rollers. Vertical seeding-blades each coat with a roller, one of the blades being fixed and the other movable to and from the fixed blade. The rollers con-

duct the cotton to the space between the fixed and movable blades. By reason of the operation of the coating fixed and movable blades the cotton-seeds are forced from the fiber. The bottom of the casing of the machine is provided with a central opening for the fiber and openings for the seed.

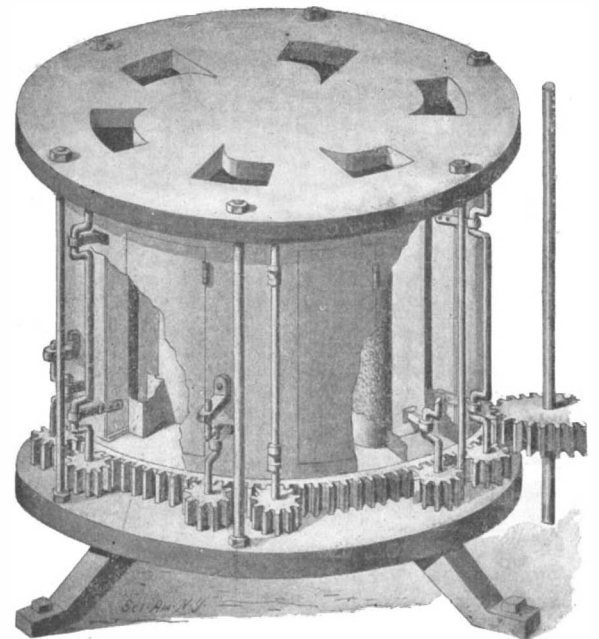
**THE WENTWORTH COTTON-GIN.**

The driving mechanism comprises a system of gearing which consists of a master-wheel having teeth on its inner edge meshing with gears on the rollers and teeth on its outer edge meshing with pinions on the cranked shafts by which the feed-board and movable blades are operated.

The capacity of the machine is regulated by the number of rollers used, one roller representing one bale per day. The hide covering of these rollers grips readily the short-linted common cottons. A gin of ten rollers will occupy about the floor space of one horizontal roller gin, or 15 square feet.

New Alkaloids of Tobacco.

Three new alkaloids of tobacco have been isolated by Messrs. A. Pictet and A. Rotschy. One of these has received the name of nicotine ($C_{10}H_{12}N_2$). It is a liquid body, easily soluble in water and the organic solvents, and has a strongly marked alkaline reaction. Its odor is agreeable, somewhat resembling that of parsley. It is extracted from nicotine in the proportion of two per cent. The second alkaloid is solid, and has received the name of nicotelline. It appears in the form of small prismatic needles, melting at 148 degrees C. The proportion of this body contained in tobacco is extremely small. It is but slightly soluble in water and ether, but dissolves easily in alcohol and chloroform. The third alkaloid, which has not yet been well examined, has been called nornicotine; its composition appears to be very close to that of nicotine, and it is supposed to be derived from it by the elimination of the methyl group attached to the nitrogen. The physiological action of these substances has not yet been determined.

The Current Supplement.

The current SUPPLEMENT, No. 1318, is filled with interesting articles. The first-page engravings are views in Taormina, one of the most beautiful places in Sicily. "The Effect of Physical Agents upon Bacterial Life" is a very practical article by Dr. Allan Macfadyen. "Information Concerning the Angora Goat" is concluded. "The Oil Fields of Baku" is by Prof. G. Frederick Wright. "The Museum of Artillery at Paris" is accompanied by a large number of interesting engravings showing arms and armor. "Wooden Railways" describes some curious old railways. The third installment of "American Engineering Progress" deals with the "Influence of Combination," which is very timely at the present moment. "A New Elliptical Cutting Machine" is by Prof.

C. W. MacCord.

Contents.

(Illustrated articles are marked with an asterisk.)	
Automobile news.....	214
Automobiles in New York.....	211
Battleship, Russian*.....	210
Boilers, water-tube.....	210
Brake, hydraulic*.....	216
Burner, wickless oil*.....	218
Canal, prospects of the.....	210
Correspondence.....	215
Cotton gin*.....	218
Electrical notes.....	215
Engineering notes.....	215
Fountains, electrical*.....	212
Heavens in April.....	211
Inventions, index of.....	219
Inventions recently patented.....	219
Motormen, training school.....	214
Notes and queries.....	210
Omniramb*.....	216
Pine wrench*.....	218
Rays, Becquerel.....	214
Salt deposit, remarkable*.....	217
Sugar reaper*.....	213
Supplement, current.....	218
Sylviculture and the Suez Canal.....	210
Tobacco, alkaloids of.....	218
Trade, advancing.....	210
Yacht, new, framing.....	210

RECENTLY PATENTED INVENTIONS.

Electrical Apparatus.

REVERSING APPARATUS FOR ELECTRICAL DEVICES.—ROBERT J. HUGHES and ALEXANDER B. SHAW, Duquesne, Pa. This apparatus comprises a reversing controller for connecting the terminals of an electric generator interchangeably with the wires of a two-wire line. The device dispenses with one set of wires usually employed in electric travelers to be found in machine-shops, and enables the motor on the traveler to be reversed with only one set of wires. By means of the novel reversing device employed the current passes through the field-coils as before, but is made to change its direction in the armature-coils in order to drive the motor in the desired direction.

Mechanical Devices.

CHIP-BREAKER.—WALTER L. CROUCH, Thomaston, Conn. The purpose of this invention is to provide a more efficient chip-breaker for molding and similar wood-working machines than has hitherto been known. The invention comprises a carrier arranged to rock around the axis of a rotary cutter and carrying a finger which engages the work to break the chips, and which moves concentrically to the axis of the rotary cutter.

KNEADING AND MIXING APPARATUS FOR SOAP.—ANATOLE and ERNEST DES CRESSONNIERES, Brussels, Belgium. The crushing, kneading and mixing apparatus is designed to subject the soap to an alternate crushing and mixing treatment in shavings, instead of subjecting it to simple crushing by means of three cylinders, thus enabling an absolute homogeneity of the paste to be obtained and permitting its mixture with color while preventing waste of soap. This alternate crushing and mixing is obtained by the arrangement of crushers in couples of two cylinders each provided with a scraping comb and placed in such a way that the shavings from the two coupled cylinders are intermixed for crushing by the next crushing-cylinders, and so on up to the last.

DIPPING-MACHINE.—JOHANN A. JENA, South Bend, Ind. The invention relates to machines for dipping, and particularly for enameling crockery and other goods. At the upper portion of a vat a dish-holder is journalled, provided with end portions having apertures. A rack has a longitudinal inner member adapted to be seated upon the peripheries of the end portions of the holder. Arms extend from the rack inwardly beyond the inner member, and are provided with projections adapted to fit into the apertures of the end portions.

DYNAMOMETER.—KARL LEVERKUS, Charlottenburg, Germany. The dynamometer serves to measure power transmitted from one shaft to another. In the dynamometers usually employed the relative revolution or distortion of the members of which they are composed is too small to render the measuring of the power easy and exact. To remedy this defect the inventor employs a toothed gearing for increasing or enlarging the motion of the lengthwise-movable part. Moreover, this lengthwise-movable part is provided with longitudinal and spiral grooves engaged by rollers on the movable part and the one member. The efficiency of the apparatus is increased and the cost of manufacture very considerably reduced.

ACTUATING MECHANISM FOR RETAINING VALVES IN AIR-BRAKE SYSTEMS.—EDWIN J. EMMONS, Brandon, Manitoba, Can. Mr. Emmons has devised a means by which all the valves are under the control of the engineer and can be simultaneously operated, the ordinary air signal-pipe of the train being utilized. The actuating mechanism comprises an air-motor having connection with the stem of the valve and with the air signal-pipe. The signal-pipe is connected with the main reservoir, and is provided with a reducing valve. The pipe has a controlling-valve. A signal-valve has connection with the pipe. By means of this invention the brakemen are no longer required to turn the handle of each retaining-valve to close the exhaust from the brake-cylinder to keep the brakes on while the engineer is recharging the auxiliary cylinders.

Designs.

TWINE-CUTTER.—BEVERLY P. HERNDON, Florence, Arizona Territory. The device consists of a ring adapted to receive one of the fingers of the hand and an S-shaped prong or arm formed in one piece with the ring and projecting laterally therefrom, the same being adapted to pass over the finger adjacent to the ring and under the next one, so that the device may be conveniently held. The cutter proper is attached to the side of the ring opposite the spring, and arranged transversely thereon, so as to be adapted for convenient use.

BOLT-GUARD.—WILLIAM TAYLOR, 40 East Harrison Street, Chicago, Ill. The bolt-guard is designed for use on doors to prevent the insertion of a case-knife or other thin blade for the purpose of throwing the bolt back. The guard is formed to present an obstruction to the entrance of the blade and so prevent its adjustment into engagement with the bolt and thus forms an efficient guard for the purpose.

NOTE.—Copies of any of these patents will be furnished by Munn & Co. for ten cents each. Please state the name of the patentee, title of the invention, and date of this paper.

Business and Personal Wants.

READ THIS COLUMN CAREFULLY.—You will find inquiries for certain classes of articles numbered in consecutive order. If you manufacture these goods write us at once and we will send your name and address to the party desiring the information. **In every case it is necessary to give the number of the inquiry.**

MUNN & CO.

- Marine Iron Works. Chicago. Catalogue free.
- Inquiry No. 299.**—For a machine for making ice in small quantities adapted for hotel and family use. For logging engines. J. S. Mundy, Newark, N. J.
- Inquiry No. 300.**—For dealers in electrical supplies, such as small motor and dynamo castings, etc. "U. S." Metal Polish. Indianapolis. Samples free.
- Inquiry No. 301.**—For gas engine adapted for acetylene gas.
- Motor Vehicles, Duryea Power Co., Reading, Penn.
- Inquiry No. 302.**—For wholesale dealers in rifles and sporting goods.
- WATER WHEELS. Alcott & Co., Mt. Holly, N. J.
- Inquiry No. 303.**—For manufacturers of special wooden and sporting articles suitable for the German market.
- Yankee Notions. Waterbury Button Co., Waterbury, Ct.
- Inquiry No. 304.**—For a carriage elevator, platform 8 by 15 feet, to hoist 11 or 12 feet, capacity 1,500 to 2,000 pounds, completed and put up.
- Brass Cups, Threaded. Bliss Chester Co., Prov., R. I.
- Inquiry No. 305.**—For the manufacturers of the "Pan-American Electric Lamp."
- La Porte Watch School, La Porte Ind. Catalogue free.
- Inquiry No. 306.**—For catalogues of paint-making machinery.
- Handle & Spoke Mch. Ober Mfg. Co., 10 Bell St., Chagrin Falls, O.
- Inquiry No. 307.**—For parties who drill deep wells with a core or bit drill.
- Machine chain of all kinds. A. H. Bliss & Co. North Attleboro, Mass.
- Inquiry No. 308.**—For machinery for extracting grease and moisture from wet glue stock and other animal refuse.
- Sawmill machinery and outfits manufactured by the Lane Mfg. Co., Box 13, Montpelier, Vt.
- Inquiry No. 309.**—For manufacturers of pressed steel for metal boxes.
- Rigs that Run. Hydrocarbon system. Write St. Louis Motor Carriage Co., St. Louis, Mo.
- Inquiry No. 310.**—For manufacturers or dealers in cheap albumen, such as that taken from blood, etc.
- SAWMILLS.—Variable friction feed. Send for Catalogue B. eo. S. Comstock, Mechanicsburg, Pa.
- Inquiry No. 311.**—For parties to make an apparatus for oaking talc.
- Ten days' trial given on Daus' Tip Top Duplicator. Felix Daus Duplicator Co., 5 Hanover St., N. Y. city.
- Inquiry No. 312.**—For manufacturers of motor fans for stores, rooms, etc.
- Wanted. Pan Am. Exposition Patent Novelties suitable for souvenirs. Address J. M. B., 320 B'way, N. Y.
- Inquiry No. 313.**—For Grimme, Natus & Co.'s calculating machine.
- For Machine Tools of every description and for Experimental Work call upon Garvin's, Spring cor. Varick Street, N. Y.
- Inquiry No. 314.**—For the manufacturer or dealer in the "kinodrome."
- Guns and Sporting Goods. Keating Wheels. New catalogue out now. The H. & D. Folsom Arms Co., 314 Broadway, New York.
- Inquiry No. 315.**—For a new, novel and ornamental article for sale in the country, not high in price.
- The celebrated "Hornsby-Akroyd" Patent Safety Oil Engine is built by the De La Vergne Refrigerating Machine Company. Foot of East 138th Street, New York.
- Inquiry No. 316.**—For a practical automobile adapted to carry six passengers, the operator and some freight; gasoline preferred.
- The best book for electricians and beginners in electricity is "Experimental Science," by Geo. M. Hopkins. By mail, \$4. Munn & Co., publishers, 361 Broadway, N. Y.
- Inquiry No. 317.**—For machines for making spring tickets.
- Government Relics—guns, swords, revolvers, saddles, cannons, etc. from Government Auction are now being sold at ridiculously low prices. Send for illustrated lists. Francis Bannerman, 579 Broadway, N. Y.
- Inquiry No. 318.**—For manufacturers of aluminum novelties.
- Wanted—Revolutionary Documents, Autograph Letters, Journals, Prints, Washington Portraits, Early American Illustrated Magazines. Correspondence Solicited. Address C. A. M. Box 773, New York.
- Inquiry No. 319.**—For hard wood veneer, birch or maple.
- Machinery for Sale.—One Cataract Tool Company lathe with slide rests, chasing attachment, milling attachment, counter attachment and chuck; one turret head lathe; five special speed lathes for light brass work. All in first-class condition, nearly new. Address The Vogt Optical Company, Rochester, N. Y.
- Inquiry No. 320.**—For manufacturers of machinery for making hair felt.
- Manufacturing agents to sell the Reagan Improved Shaking Grate. We will guarantee to evaporate 25 per cent more water than any other grate on the market and do this when evaporating as many pounds of water per pound of coal as you do now. Good men wanted in all parts of the United States. Write for particulars and terms. Reagan Grate Bar Co., 209 North Front Street, Philadelphia, Pa.
- Inquiry No. 321.**—For manufacturers in the United States of antimony goods such as plugs, seats, cocks, etc.
- For Sale.—A fine man'g business, articles covered by patent. You will say it is a chance of a lifetime; we have filled export orders to four foreign countries. Answer and we will give you all particulars. Address G. Box 773, N. Y.
- Inquiry No. 322.**—For manufacturers of novelties for advertising purposes.
- Inquiry No. 323.**—For manufacturers of fiber conduit.
- Inquiry No. 324.**—For manufacturers of fire escapes.
- Inquiry No. 325.**—For a burglar alarm that uses a blank cartridge, and which can be attached to a door or window.
- Inquiry No. 326.**—For manufacturers of glass marbles or small glass balls, 5/16 or 3/8 inch.

- Inquiry No. 327.**—Formachinery used in pickling factory, such as steam kettles, etc.
- Inquiry No. 328.**—For manufacturers of glass bottles for pickles.
- Inquiry No. 329.**—For manufacturers of a thermometer with an electric attachment which rings a bell when the thermometer gets low or high.
- Inquiry No. 330.**—For manufacturers of light malleable iron castings.
- Inquiry No. 331.**—For makers of open eye bolts, size, 3/8 iron.
- Inquiry No. 332.**—For outfits for making rubber stamps.
- Inquiry No. 333.**—For manufacturers of steel street letter boxes; to be constructed of well finished soft rolled steel 18 gage English standard, and back to be of Bessemer steel 11 gage English standard.
- Inquiry No. 334.**—For dealers in electric batteries for discharging dynamite.
- Inquiry No. 335.**—For parties to make wooden staples and easels in quantities.
- Inquiry No. 336.**—For a glue filter which will clarify glue liquors.
- Inquiry No. 337.**—For manufacturers of waxing machines for tissue paper.
- Inquiry No. 338.**—Wanted to buy one portable, galvanic cautery battery with conducting cables and electrodes.
- Inquiry No. 339.**—For manufacturers of augers for boring wooden pump logs and rills for fitting the same.
- Inquiry No. 340.**—For a manufacturer of a hand drilling diamond drill.
- Inquiry No. 341.**—For parties to manufacture a vehicle simple in construction, propelled by hand and foot power and run on two wheels, front and back and two side wheels.
- Inquiry No. 342.**—For manufacturers of dynamos of about 8 volts.
- Inquiry No. 343.**—For dealers in silk-worm gut for use in fishing tackle.
- Inquiry No. 344.**—For machines for automatic numbering in printing.
- Inquiry No. 345.**—For machinery for making feather dusters.
- Inquiry No. 346.**—For manufacturers of pneumatic coating machines for applying whitewash.
- Inquiry No. 347.**—For parties willing to manufacture a number board, patented, in some Eastern city.
- Inquiry No. 348.**—For parties engaged in building theaters.
- Inquiry No. 349.**—For manufacturers of meteorological instruments.
- Inquiry No. 350.**—For manufacturers of kilns for burning lime continuously; kilns from which the lime can be taken out without interfering with the burning.
- Inquiry No. 351.**—For manufacturers of air compressors to lift water out of wells.
- Inquiry No. 352.**—For fans run by spring or weight, for ceiling or otherwise.
- Inquiry No. 353.**—For machinery for bending brass and iron tubing.
- Inquiry No. 354.**—For manufacturers of spring steel.
- Inquiry No. 355.**—For manufacturers or dealers in small ball-bearing hubs, also spokes and nipples for constructing small wheels, of 16 inches in diameter.

Notes & Queries

HINTS TO CORRESPONDENTS.

Names and Address must accompany all letters or no attention will be paid thereto. This is for our information and not for publication. References to former articles or answers should give date of paper and page or number of question. Inquiries not answered in reasonable time should be repeated; correspondents will bear in mind that some answers require not a little research, and, though we endeavor to reply to all either by letter or in this department, each must take his turn. Buyers wishing to purchase any article not advertised in our columns will be furnished with addresses of houses manufacturing or carrying the same. Special Written Information on matters of personal rather than general interest cannot be expected without remuneration. Scientific American Supplements referred to may be had at the office. Price 10 cents each. Books referred to promptly supplied on receipt of price. Minerals sent for examination should be distinctly marked or labeled.

(8144) B. B. asks: What power the motor requires, described in December 8 and 15 copies of the SCIENTIFIC AMERICAN? Also, which are the best batteries to use—the bi-chromate of potash or storage batteries—and how many of each? If storage batteries are the best, what make is the best, and what size? A. Or cell f either of these batteries will run the motor. It makes no difference which is used. Any size will answer, and any make. We do not suppose there is any such thing as a best in these cells. It requires 4 or 6 cells for doing work.

(8145) A. L. L. asks: 1. Can a satisfactorily illuminated picture be produced with acetylene gas light in a moving-picture machine, or can only oxyhydrogen gas (lime light) and electric (arc) light be used? A. The acetylene burners as used in lanterns do not give much above 100 candles, and it is not supposed that a moving picture can be properly illuminated with such a light. 2. Which is the cheaper to use, acetylene or oxyhydrogen gas, when it is made for its own use, and about what will it cost. A. Acetylene is cheaper than the oxyhydrogen light, but there is in it very much less light. Per candle, we presume acetylene is cheaper. Calcium carbide can now be had for a moderate price. We have not the exact figure for the present time. Our advertisers can give them on application.

(8146) C. W. W. asks: Can hilly roads be climbed easier on a high-gear bicycle, say, 80 or 90, than on a low gear, 55 or 60? What is the philosophy of it? A. The hill can be climbed by rider on a low-gear machine easier than on a high-gear machine, because with the low gear he does not have to lift himself so far up the hill with one tread as with the high gear. A 90 gear goes half as far again for one tread as a 60 gear, and therefore requires 1 1/2 times the work for one revolution of the pedal.

(8147) J. W. B. writes: I am trying to make some bar and U magnets, and am

having bad luck. What shall I do? A. For permanent magnets use only the best tool steel, Jessop's or Stub's, though fine American tool steel will doubtless give satisfactory results. Harden the ends only glass hard. It is useless to harden the whole length of the bar. Wind a coil into which the bar will slip easily of any convenient size of wire, and with perhaps 100 turns, the number is not important. There should be enough that the coil will not heat badly when in circuit. Put the coil in circuit with your dynamo of lowest voltage, and while the current is flowing push the bar to be magnetized to and fro from end to end of the bar in the coil, stopping at the middle at last. Open the circuit and remove the bar, which should be strongly magnetized.

(8148) R. R. W. asks: 1. In an isolated district would it be feasible to run a 1 or 2 horse power dynamo for private house and barn lighting, by means of a windmill? Could storage batteries be used without great expense when the wind would not blow—the dynamo to be used for charging? A. Very good results have been obtained in operating an electric-lighting plant from a windmill and storage battery in country districts. It must not be expected that the light will be obtained at less expense than oil. 2. Immediately above the photosphere of the sun lies a layer of gases having a spectrum. What name do astronomers give to the spectrum? A. The layer is the reversing layer of the sun. It is composed of the vapors of metals, and the spectrum of a vapor is a line or discontinuous spectrum. Such a spectrum is given by sodium, for example. It consists of two yellow lines. 3. In what year was the first patent for a level gear to a bicycle granted? What book could I look up to learn the particulars? A. We cannot state the year. No one can claim the use of level gear on bicycles uncombined with any other feature.

(8149) A. S. writes: Please give the dimensions of the face of the cam, with a diagram, if possible, of the simple engine described in the issue of the SCIENTIFIC AMERICAN of November 17, 1900. A. The an-

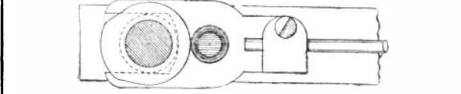

nexed cut shows the cam roller and fork full size.

(8150) W. H. B. asks: Is it necessary, in order to make a spark that the two glass plates of a Wimshurst machine should revolve at the same speed? A. It is not necessary that the plates of a Wimshurst machine should revolve at the same speed, though it is usually simpler to have them do so.

(8151) B. T. M. asks: Which is the heavier, dry air or an equal volume of moist air, each under the same pressure and at the same temperature? A. Moist air is lighter than dry air at the same temperature and pressure. Water vapor is only about 1/8 as heavy as air.

(8152) R. P. W. writes: A curious explosion occurred February 15 at the house of Mr. Rufus P. Williams, Cambridge, Mass. A new, quart, beer bottle was nearly filled with water which had been run through a Pasteur filter. It was tightly closed by the usual beer-bottle device, and at first put into the cellar, subsequently being placed on a marble washstand in a room at, say, 70 deg. F.—about the temperature at which it was filled. After standing some three or four hours, it suddenly exploded, landing the base and neck of the bottle a foot away in the wash bowl. The glass was about 0.5 centimeter in thickness. A. The breaking of the bottle must have been caused by the straining of the glass from some cause in the making of the bottle. It was not an explosion in the ordinary sense of the term. The parts did not fly far enough to be propelled by expanding gas. The force of the cracking glass threw the parts a foot or so. The case of the ink bottle recently published in our columns is similar to this.

TO INVENTORS.
An experience of over fifty years, and the preparation of more than one hundred thousand applications for patents, at home and abroad, enable us to understand the laws and practice on both continents, and to possess unequalled facilities for procuring patents everywhere. A synopsis of the patent laws of the United States and all foreign countries may be had on application, and persons contemplating the securing of patents, either at home or abroad, are invited to write to this office for prices, which are low, in accordance with the times and our extensive facilities for conducting the business. Address MUNN & CO., office Scientific American, 361 Broadway, New York.

INDEX OF INVENTIONS

For which Letters Patent of the United States were Issued for the Week ending MARCH 26, 1901, AND EACH BEARING THAT DATE.

[See note at end of list about copies of these patents.]

Abdominal bandage, E. A. Richmond.....	670,814
Adjustable wrench, J. C. Burgess.....	670,890
Air brake, F. Linco.....	670,901
Air-ship, O. Olsen.....	670,807
Alarm, C. H. Bryan.....	670,702

(Continued on page 220)

Alloys of iron and hydrogen, making, G. W. Goshier..... 670,775
Ammunition hoist, Matthews..... 670,775
Anderson, J. D. Cox..... 670,471
Animal trap, J. W. Barnes..... 670,757
Animal trap, I. Hyman..... 670,449
Animal trap, T. D. & C. Sapp..... 670,736
Ashes, device for use in extracting, E. C. Cole..... 670,767
Assurance apparatus, C. G. Beechey..... 670,527
Atomizer, C. H. Gulbor..... 670,494
Automatic running gear, L. T. Gibbs..... 670,776
Automatic operating switch, G. W. Specht..... 670,907
Ax or tool, camper's, E. K. Leffingwell..... 670,790
Axle box, car, W. F. Richards..... 670,642
Axle, vehicle, J. Parr..... 670,596
Bag. See Paper bag. Wash bag.
Bag cleaning apparatus, G. F. Goddard..... 670,609
Baking apparatus, W. S. Hadaway, Jr..... 670,668
Balling press, P. K. Dederick..... 670,505
Bandage suspensory, J. Jarrell..... 670,428
Bank or toy safe, coin, M. S. Clarke..... 670,841
Basket, laundry, J. E. Cutcliff..... 670,848
Bath apparatus, portable steam or vapor, M. Rostovsky..... 670,545
Battery element, secondary, J. T. Storey..... 670,648
Bed and feet heater, E. T. Keener..... 670,786
Bed and fire escape, combined spring, I. U. Malphurs..... 670,798
Belt, Garford Hunt..... 670,708
Belt, G. L. Pierce..... 670,726
Bicycle, T. L. Dennis..... 670,608
Bicycle brake, L. N. Dyrberg..... 670,473
Bicycle driving mechanism, Mahana & Pompe..... 670,715
Bicycle luggage carrier, F. H. Cowles..... 670,503
Bicycle support, R. P. Finley..... 670,422
Blinder, loose sheet, W. F. E. Gurley..... 670,666
Blotting pad, O. J. Deckmann..... 670,853
Boat hoisting or lowering device, S. Bergstein..... 670,659
Boat lowering device, Allen & Danforth..... 670,831
Boiler furnace, marine, J. O. Morris..... 670,719
Book mark, M. G. Carleton..... 670,766
Bottle capping machine, H. G. Davis..... 670,768
Brake shoe, J. P. McIntyre..... 670,639
Bran duster and grain scourer, G. R. Davidson..... 670,851
Bridges, W. F. Walker..... 670,670
Broom, antiseptic, O. S. Kulman..... 670,713
Brush and dentifrice bracket, C. A. Kirkwood..... 670,481
Buckle, E. W. Groeschel..... 670,493
Burnishing machine, J. B. Carolin..... 670,703
Cabinet, W. Downie..... 670,558
Calculating kettle agitator, W. T. Powers..... 670,597
Calcium carbide, treating, Borch & Hvild..... 670,607
Camera timing attachment, Fernbuter..... 670,635
Can. See Sheet metal can.
Can capping machine, Bergland & Teigen..... 670,835
Canceling and postmarking machine, stamp, J. L. Lister..... 670,619
Candle holder, J. Thomas..... 670,625
Car door, hopper bottom, G. I. King..... 670,615
Car draft rigging, railway, G. P. Ritter..... 670,734
Car, hopper bottom, G. A. Hancock..... 670,614
Car, railway, E. H. Blossom..... 670,526
Car seat ticket holder, F. K. Stephens..... 670,647
Car ticket holder, railway, G. F. Sanborn..... 670,623
Carpet sweeper, Johnston & Stewart..... 670,513
Carriage wheel, horseless, J. Caulfield..... 670,664
Carburetor, R. E. Olds..... 670,921
Carburetor, W. J. Powers..... 670,433
Carburetor, C. I. Tenney..... 670,599
Case or box holding block, Fletcher & Bulkley..... 670,446
Casein and producing same waterproof, A. Schmidt..... 670,689
Casting elevator, J. J. Davin..... 670,704
Caster, J. P. Henries..... 670,426
Casting, steel, A. G. Lundin..... 670,453
Chain grate furnace, F. R. Tibbitts..... 670,694
Chair. See Dental chair.
Chairs, etc., clutch for adjusting rods for adjustable back, C. H. Clement..... 670,896
Chart, V. Bowman..... 670,762
Chimney cowl, Mills & Reese..... 670,682
Chisel making die, J. Swan..... 670,742
Chuck, nipple, D. Collins..... 670,468
Churn, J. H. Cooper..... 670,469
Cigar bunch rolling machine, S. Wulkan et al..... 670,574
Cigar protector, W. G. B. Tyrrell..... 670,462
Clamp making machine, F. P. Cady..... 670,891
Clasp. See Lacing clasp.
Cleaning or polishing machine, C. F. & C. H. J. Dilg..... 670,856
Clock, electric, F. L. Gregory..... 670,634
Coal loading apparatus, J. L. Lamb (re-issue)..... 11,898
Coaster and brake, J. G. Ziegler..... 670,575
Cock, ball, J. M. Smith..... 670,818
Coin, N. O. Emery..... 670,894
Commutator, G. W. Nistic..... 670,454
Compass, ship's, W. J. Reynolds..... 670,733
Composition, J. Kelsey..... 670,919
Compound engine, S. M. Vauclain..... 670,745
Concentration, process of, Sutton & Steele..... 670,441
Copied effects, apparatus for producing press, B. S. Creamer..... 670,472
Corn, machine for hulling green, J. Ritty..... 670,687
Cotton chopper, P. Caldwell..... 670,564
Crum whipper, A. S. Benedict..... 670,834
Cultivator, A. Lindgren..... 670,885
Cultivator, listed corn, C. C. Keith..... 670,541
Current machine and apparatus, continuous, M. Derl..... 670,557
Curtain rod, H. A. Fowler..... 670,585
Curtain stretcher frame, R. Hoffheins..... 670,589
Cut out, suspension, J. J. Wood..... 670,573
Cutter boxing, H. Gaucho..... 670,448
Cutting rod, oval blanks machine for, C. W. Hobbs..... 670,636
Cycle, motor, G. M. Holley..... 670,590
Dental chair, E. M. Fredericks..... 670,773
Dental plate, A. Biber..... 670,604
Dibber, J. Hall..... 670,874
Digerator for chemical treatment of substances, B. S. Summers..... 670,485
Display cabinet for spoons, etc., A. E. Cobb..... 670,555
Ditching machine, J. H. Koehler..... 670,787
Door check, G. Stubbs..... 670,821
Door fastener, J. F. H. Deibel..... 670,854
Door hanger, sliding, A. Newell..... 670,640
Door holder, P. F. Lehmann..... 670,791
Door or window screen fastener, J. W. Lyons..... 670,797
Doors, etc., antirattling device for, D. G. Musselman..... 670,515
Draft equalizer, W. C. Campbell..... 670,839
Draft equalizer, A. H. Niesley..... 670,431
Draft equalizer, H. Spangue..... 670,459
Draft regulator, J. A. Selph..... 670,739
Drier, cooker, and presser, combination, A. Schmidtseder..... 670,436
Drill, H. Paulson..... 670,543
Drill socket, J. D. Cox..... 670,470
Drip pan alarm attachment, Wahl & Keyes..... 670,463
Elevator safety device, A. Carson..... 670,535
Eaves trough hanger, C. A. Karpenstein..... 670,675
Electric accumulators, apparatus for forming elements for, W. Gardner..... 670,774
Electric battery, primary, J. P. Fontaine..... 670,583
Electric heater, W. S. Hadaway, Jr..... 670,667
Electric light handle and adjuster, E. E. Brown..... 670,552
Electric light shield and reflector, Clark & Ernst..... 670,536
Electric waves, coherer for detecting, A. Koepsel..... 670,711
Electrical connecting device, J. S. Schenck..... 670,547
Electrical distribution, J. B. Entz..... 670,476
Electrical heating resistance and making same, W. S. Hadaway, Jr..... 670,671
Electrically operated brake, G. D. Burton..... 670,415
Elevator, H. Bolander..... 670,496
Elevator safety device, V. H. Yarnall..... 670,830
End gate, J. C. Butler..... 670,532
Engine, R. D. Watson..... 670,867
Engines, sparking igniter for internal combustion, C. H. Blomstrom..... 670,914
Envelope, Keller & Titaworth..... 670,882
Exercising machine, E. R. Ernst..... 670,706
Expanding clamp, J. Marquardt..... 670,922
Eye-glasses, H. F. Wallace..... 670,652
Fabric, knitted, J. F. Behny..... 670,759
Farm or yard gate, H. W. Thompson..... 670,650
Fastener, Applebon & Sibenthaler..... 670,655
Fastening devices for gloves, etc., manufacture of, W. B. Murphy..... 670,721
Fastening, fixture, J. Krodel..... 670,789
Feeder, boiler, J. N. Rice..... 670,813
Feeder, calf, M. L. Swope..... 670,823

Feeding device, W. H. Baush..... 670,910
Fence, water, Walton & Ball..... 670,464
Fence wire tightener, P. Boger..... 670,661
Fiber winding and curling machine, S. A. Flower..... 670,540
Fire escape, hydraulic telescopic, W. H. Silger..... 670,548
Fireproof construction, F. W. Garretson..... 670,478
Fireproof door or shutter, I. W. Emerson..... 670,858
Fireproof partition, J. C. Perry..... 670,909
Fluid pressure engine, E. A. Stark..... 670,439
Folding box, J. Clarke..... 670,840
Folding box, F. H. Houghland..... 670,612
Fork for handling heaves, L. C. Sturman..... 670,822
Fruit brusher, H. B. Ruggles..... 670,457
Fruit gatherer, W. H. Spencer..... 670,568
Fruit packing device, C. W. Arrasmith..... 670,525
Funnel, D. S. Horton..... 670,512
Furnace front, J. B. Houston..... 670,781
Gage, Traut & Gerry..... 670,927
Game device, I. M. Van Wagner..... 670,487
Garbage burner, domestic, E. S. Nowlab..... 670,806
Garment stretcher, W. H. Shindler..... 670,817
Gas engine, T. McMahon..... 670,803
Gas engine, duplex, W. O. Worth..... 670,550
Gas generator, acetylene, J. S. McGinn..... 670,542
Gas generator, acetylene, W. G. Ross..... 670,815
Gas generator, acetylene, J. H. Willers..... 670,696
Gas machine, acetylene, W. J. Baulieu..... 670,657
Gas, preparing materials for purifying, J. P. Ihart..... 670,450
Gas, preparing materials for purifying illuminating, J. P. Ihart..... 670,451
Gate, Mcke..... 670,722
Generator, F. Windham, Jr..... 670,829
Glass moulding machine, F. & A. Shuman..... 670,438
Glass pressing apparatus, W. Buttler..... 670,764
Glazier's point, J. O. Thilow..... 670,649
Go-cart, A. E. Howlett..... 670,918
Golf club, E. F. Thompson..... 670,522
Grain elevator, fireproof, J. L. Record..... 670,456
Grain elevators, adjustable spout and cover for, Jordan..... 670,881
Grain heater, M. W. Hunt..... 670,638
Graphophone record duplicating machine, C. S. Tainter..... 670,442
Grease cup, J. Power..... 670,516
Grinding machine, O. S. Walker..... 670,523
Grinding or polishing disk, D. J. Murnane..... 670,593
Gun, air, F. Bennett..... 670,760
Gun mount, F. Sachs..... 670,906
Guns, ramrod and jacket for rapid fire or machine, F. Sachs..... 670,735
Gyration machine supporting apparatus, J. Warrington..... 670,653
Hair structure, H. Dorenwend..... 670,857
Hand, artificial, A. C. Mueller..... 670,684
Hand rake, W. Cronk..... 670,417
Handle. See Lever handle. Trunk handle.
Harness attachment for poles and shafts, W. F. Schafer..... 670,435
Harp, S. Raffael..... 670,732
Harrow, J. B. Gebhardt..... 670,709
Harrow, disk, R. L. Wight..... 670,524
Harvester attachment, O. Nygren..... 670,455
Harvester reel, C. Bransgrove..... 670,662
Hat and coat hanger, F. Marek, Jr..... 670,680
Hat fastener, E. T. Miller..... 670,482
Hat fastener, F. Staufenberger..... 670,501
Hay press, R. D. Emmons..... 670,421
Hay press, J. W. Trout..... 670,461
Heating apparatus, S. Schwarzschild..... 670,437
Heating apparatus, steam, J. A. Donnelly..... 670,893
Hinging machine, box, D. H. Saunders..... 670,816
Hook and eye, T. J. Browning..... 670,701
Hop drier and curer, J. K. Mount..... 670,620
Hopper discharge device, Waechter & Hetzel..... 670,747
Horseshoe nail points, machine for forging, Pierce & Newell..... 670,622
Horseshoeing apparatus, G. N. Barcus..... 670,603
Hub, vehicle, Kelly & Keena..... 670,480
Hydrocarbon heater, A. Fillgrove..... 670,769
Hydrometer and syringe, combined, T. D. Bunce..... 670,663
Ice machine valve, W. J. Francke..... 670,770
Ice planer, H. Bodenstein..... 670,698
Incubator, D. C. Coble..... 670,490
Indexing machine, L. B. Thomas..... 670,517
Indicator, J. J. McTigue..... 670,903
Ironing machine, E. G. Smith..... 670,567
Irrigation, pump battery system for rice, E. M. Ivens..... 670,784
Kiln for burning or calcining limestone, W. Spencer..... 670,820
Kitchen table, G. C. Conklin..... 670,845
Knitted fabric and producing same, W. H. Jackson..... 670,880
Knitting machine attachment, automatic circular, Black & Dodd..... 670,489
Knitting machine, circular, H. Clarke..... 670,892
Knitting machine, circular, L. N. D. Williams..... 670,828
Knitting machine needle, E. E. Newton..... 670,886
Lacing clasp, shoe, E. B. Hoegemann..... 670,561
Lamp burner, attachment, G. H. Rose..... 670,633
Lamp, electric arc, E. A. Beck..... 670,658
Lamp, gasolene, G. Ruppel..... 670,484
Lamp, hydrocarbon incandescent, P. B. Curran..... 670,630
Lamp shade or reflector, R. W. Pittman..... 670,905
Lamp supporting bracket, R. W. Pittman..... 670,904
Lantern, P. C. Bemis..... 670,913
Last, L. Lanols..... 670,574
Lath, H. Dent..... 670,506
Lathe feed attachment, E. H. Mack..... 670,430
Lathe tool post, R. M. Russell..... 670,546
Lathe, turret, D. B. Bullard..... 670,837
Legging, J. Pullman..... 670,838
Lens cutting and edging machine, Morgan & Brown..... 670,500
Letter box, W. L. Vestal..... 670,825
Lever handle, lock, A. Weaver..... 670,571
Liquid separator, centrifugal, G. J. R. Strom..... 670,669
Lock key holder, T. S. Thorn..... 670,626
Loom picker stick lug strap, O. A. Lyon..... 670,429
Lubricants, making, M. S. Hudnall..... 670,783
Machinery legs, securer for, M. Brodeur..... 670,763
Mail bag catcher, Sorensen & Alden..... 670,693
Mail box, collection and delivery, J. P. Brown..... 670,553
Mail box, rural delivery, C. Pfeiffer..... 670,686
Mandrel and chuck, expanding, A. A. A. Byrd..... 670,533
Marker, land, F. M. Engle..... 670,705
Mashing and brewing apparatus, L. Prochazka..... 670,730
Mashing grain, F. Stitzel..... 670,520
Massage apparatus, J. A. Riviere..... 670,688
Match making machine, C. R. Bannibr..... 670,656
Meat chopper, H. K. Wood..... 670,572
Metal and wood working machine, combination, G. W. Hoadley..... 670,672
Metal expanding machine, L. E. Curtis..... 670,606
Metal plates, machine for upsetting edges of, G. J. Hoskins..... 670,498
Metal sheets or plates, clamp for bundling corrugated, F. G. Caldwell..... 670,765
Metal structure, expanded, C. B. White..... 670,827
Moistening, closing, and applying stamps to envelopes, machine for, W. S. Post..... 670,729
Molding apparatus, J. C. Reed..... 670,641
Molding frame or box, L. Tillet..... 670,695
Monkey wrench, F. X. Miller..... 670,799
Motion converting mechanism, M. L. Knapp..... 670,884
Mower and roller, combination power lawn, W. P. Simpson..... 670,458
Musical instruments, pneumatic or bellows for, T. P. Brown..... 670,700
Needle, belt lacing, N. M. Cripe..... 670,445
Needle holder, W. C. Crowe..... 670,665
Nest protector, hen's, C. F. Auer..... 670,832
Oil burner for heating purposes, C. Blumer..... 670,660
Oil can, W. H. Erwin..... 670,509
Ornament sighting apparatus, A. A. Common..... 670,579
Ore concentrator, electric, Sutton & Steele..... 670,440
Organ, portable, P. P. Bilhorn..... 670,551
Oven, baking, A. J. Baxley..... 670,911
Packing piston rod, E. Reynolds..... 670,565
Pad. See Blotting pad.
Pail support, milk, W. C. Adams..... 670,628
Paint compound and making, G. R. King..... 670,678
Paper bag, A. Diem..... 670,507
Paper box, E. M. Scott..... 670,690
Paper coating machine, C. F. W. Schumacher..... 670,518
Paper cutters, combined auxiliary gage and clamp for, H. P. Hammond..... 670,876
Paper folding and stapling machine, E. C. Seymour..... 670,624
Paper holder, H. Hornbostel..... 670,562
Paper, manufacture of, Friese-Greene & Knell..... 670,511
Paper wrappers for bottles, machine for making, E. Bowen..... 670,761

Pattern, drag, J. G. Johnston..... 670,613
Pegging machine anvil, I. Frechette..... 670,771
Pegging machine presser foot, I. Frechette..... 670,772
Pegs, J. E. O. Dahlberg..... 670,846
Photographic roll holder, W. N. Moore..... 670,683
Photographic shutter, N. A. Cobb..... 670,843
Photomicrographic plate holder, N. A. Cobb..... 670,844
Pianoforte, C. R. S. J. Halle..... 670,875
Picture, H. H. Vinton..... 670,826
Picture hanger, I. H. Solomon..... 670,692
Pipe and nut wrench, adjustable, H. J. Martin..... 670,610
Pipe and pipe coupling, A. Fowle, Jr..... 670,870
Pipe hanger, J. R. Drozeski..... 670,870
Pipes and protecting covers made of plastic materials, mouthpiece for presses for the manufacture of, C. Hoffmann..... 670,611
Plauter, corn, T. Knapp..... 670,781
Planter, corn, Olsen & Evanson..... 670,467
Planter, cotton, R. A. Brown..... 670,467
Planter, pea, E. W. Hubbard..... 670,870
Plow, J. A. Lee..... 670,514
Plow, C. E. A. Swebluis..... 670,733
Plowshare fastener, Shock & Russell..... 670,566
Pneumatic tool, W. H. Soley..... 670,645
Pokey, animal, C. H. McBroom..... 670,800
Poultry decapitating device, P. J. Higgins..... 670,479
Power transmitting apparatus, J. N. & L. D. Fulton..... 670,447
Posting device, E. S. Weatherly..... 670,908
Press. See Balling press. Hay press.
Pressure regulator, E. B. Erwin..... 670,539
Primary battery and regenerating same, H. K. Hess..... 670,877
Printing and product thereof, W. Friese-Greene..... 670,510
Printing, changeable form for, L. K. Mearkle..... 670,718
Printing press attachment for printing from linked ribbons, C. E. Adamson..... 670,576
Profile instrument, W. M. McCarty..... 670,594
Projectile, firearm, H. E. Pool..... 670,728
Protractor, draftsman's, D. J. Kelsey..... 670,677
Pruning shears, W. Cronk..... 670,416
Pump, P. J. Bode..... 670,868
Pump, double acting, W. R. Lynch..... 670,796
Pump, portable air, J. C. Phelps..... 670,811
Pump, power force, P. A. Myers..... 670,902
Quilting frame, H. Glacken..... 670,872
Rack generating machine, E. R. Fellows..... 670,859
Rails, etc., apparatus for increasing the cross sectional area of metal, G. S. Merrill..... 670,592
Rails, etc., increasing the cross sectional area of metal, G. S. Merrill..... 670,591
Railway brake, A. Duppler..... 670,419
Railway brake, A. Green..... 670,873
Railway, electric, W. T. Van Dorn..... 670,651
Railway signaling apparatus, P. Bemis..... 670,912
Railway tie and chair, metallic, B. R. Allhouse..... 670,754
Railway tie, composite, C. C. Harrell..... 670,495
Railways, switch mechanism for surface contact, Hanchett & Murphy..... 670,425
Railways, unit-multiple system of electric, F. C. Esmond..... 670,896
Range gas attachment, F. L. Sheppard..... 670,740
Range drill, A. Kery..... 670,710
Reach control, T. Beator..... 670,434
Refrigeration system, C. W. Coleman..... 670,915
Revolver cylinder latch, O. F. Mossberg..... 670,862
Rock-drill, W. Wood..... 670,750
Rocker arm, A. Cowperthwait..... 670,556
Rolling apparatus, sheet-metal, B. E. V. Luty..... 670,920
Rolling mill guide, T. V. Aills..... 670,654
Roofing pin, F. B. Henderson..... 670,779
Roofing, connecting corrugated metal sheets for, F. A. Abelevan..... 670,753
Roofs weatherproof, means for rendering grooved tile, G. A. Neberling..... 670,723
Rotary engine, compound, I. M. House..... 670,637
Saddron, Hoyt & Minturn..... 670,499
Sash balance, R. A. Mackenzie..... 670,679
Scoring device, F. P. Gorin..... 670,610
Seaming machine, double, W. F. Daniels..... 670,632
Seeding machine and fertilizer distributor, O. L. Carmichael..... 670,534
Shade adjuster, window, H. M. Sturgis..... 670,460
Shade roller, E. F. Hartshorn..... 670,587
Shafting flexible, P. Weddeler..... 670,748
Sheave, J. R. Ball..... 670,756
Sheet metal can, J. C. Lewis..... 670,618
Sheet metal can, J. M. Mungiven..... 670,720
Sheet metal edging machine, A. Danzer..... 670,594
Shingle machine, F. Bader..... 670,602
Ship's course recorder, J. Hope..... 670,861
Shutter bower, J. Hoopes..... 670,780
Signal device, rural, F. C. Bates..... 670,833
Silk finishing machine, J. White..... 670,749
Sink, J. A. Duffy..... 670,418
Sled propeller, A. M. Banks..... 670,526
Smoke distributor, M. B. Cope..... 670,580
Solenoid, F. L. Lippcott..... 670,792
Solar generator, A. G. Enes..... 670,916
Speed indicator, R. N. Powers..... 670,432
Spoon holder, B. Anderson..... 670,502
Spring seat, J. F. Pope..... 670,483
Stacker and derrick, hay, M. C. Hutchings..... 670,674
Stamp mill attachment, L. R. Tulloch..... 670,549
Starting gate, T. Barnett..... 670,578
Steam engine, J. W. Powers..... 670,863
Steam engine for air compressors, G. E. Petsche..... 670,810
Steam trap, B. F. Allen..... 670,909
Stereoscope, J. S. Wyatt..... 670,752
Stokers, driving mechanism for mechanical, H. R. Nelson..... 670,804
Stone sawing machine hanger, G. D. Hunter..... 670,673
Stopper. See Tube stopper.
Storage battery, J. B. Entz..... 670,474
Storage battery, W. S. Hadaway, Jr..... 670,669
Stove, gas, E. J. Daschbach..... 670,850
Stove, heating, J. Simpson..... 670,741
Stove, hot blast, J. Kennedy..... 670,883
Straw discharger and shredder, M. A. Flaunt..... 670,860
Street and station indicator, F. Schubert..... 670,644
Stuffing box, oscillating, D. W. Kenney..... 670,900
Sulfuric anhydride, apparatus for making, W. Hasenbrich..... 670,559
Tacking tool, hand, A. Dechart..... 670,496
Tape, electric, for discharging..... 670,581
Tap, expanding, G. H. Burley..... 670,531
Tay wrench, W. E. Horsfield..... 670,899
Telegraphy, system of, F. Bedell..... 670,697
Telephone circuit, subscriber's, W. W. Dean..... 670,538
Telephone receiver, C. H. North..... 670,564
Tentering or stretching machine cloth holder, J. A. Eudon..... 670,598
Thill coupling, T. J. Gibbons..... 670,491
Threshing concave and tooth, G. S. Lowell..... 670,714
Tile setting, W. v. Baumbach..... 670,465
Tiles, etc., kiln for glazing, R. Gustavino..... 670,777
Tire, pneumatic, P. W. Tillinghast..... 670,806
Tire, vehicle, J. Pfeiffer..... 670,544
Titanium compound and making same, H. Spence..... 670,819
Tobacco, combined stamping and tagging machine for plug, P. A. Bonroe..... 670,836
Tobacco curing case, A. L. Fisher..... 670,423
Tobacco leaf booking block, N. Du Brul..... 670,508
Toy, automatic diving, S. G. Poli..... 670,727
Toy cannon, rapid fire, C. T. Bonn..... 670,629
Train control, unit multiple system of, F. C. Esmond..... 670,897
Train control, unit multiple system of electrical, F. C. Esmond..... 670,898
Trolley wheel, R. Kuhn..... 670,855
Trunk handle, W. B. Gould..... 670,492
Truss support, hernial, W. F. Brownell..... 670,530
Tube stopper, E. Blamey..... 670,528
Tunnels for sewers, etc., construction for, O. Guthrie..... 670,778
Typewriting machine, C. A. Bennett..... 670,880
Typewriting machine, E. A. Brooks..... 670,699
Typewriting machine, keyboard cover, G. P. Seipel..... 670,477
Typewriting machine ribbon mechanism, H. L. & F. L. Wagner..... 670,600
Valve, J. B. Lott..... 670,794
Valve, H. A. Wood..... 670,601
Valve and air brake mechanism, automatic equalizing check, W. S. Morris..... 670,563
Valve balancing device, engine, L. D. Lovick..... 670,795
Valve, cut off, F. H. Bates..... 670,758
Valve, engine, T. Winship..... 670,444
Valve for infating bottles, E. F. Pickett..... 670,725
Valve gear, explosive engine, A. J. Frith..... 670,871
Valve, self flushing time, G. E. Ridgway..... 670,888
Valve, throttle, Schmidbauer & Ernst..... 670,737
Vapor burner, incandescent, L. S. Pfouts..... 670,887

Vehicle brake, O. Heylmann..... 670,560
Vehicle, motor road, J. Vollmer..... 670,746
Vehicle running gear, M. Payne..... 670,724
Vehicle wheel, E. Thompson..... 670,824
Vehicles by electricity, means for propulsion of, Newman & Ledwinka (reissue)..... 11,899
Velocipede, E. G. Latta..... 670,617
Velocipede crank axle, J. P. Scovill..... 670,519
Vending machine, coin controlled, Roney & Harrison..... 670,864
Ventilating apparatus, W. E. Vernon..... 670,443
Vise, band, E. H. Kreider..... 670,788
Voting machine, A. A. Farwell..... 670,633
Voting machine, G. L. Hoxie..... 670,427
Voting machine, St. Louis & Barceloux..... 670,521
Wagon brake, R. F. Armstrong..... 670,755
Wagon brake, Schmidt & Haas..... 670,738
Wagon brake, automatic, T. Howie..... 670,782
Wagon, dumping, J. F. Chevalier..... 670,695
Wall construction, Fisher & Brouse..... 670,707
Warp machine, circular, H. Hill..... 670,497
Washer machine, J. C. Davis..... 670,852
Water bag, Hogan & Melnecke..... 670,878
Water closet, siphon, W. E. Hinsdale..... 670,588
Water cooling device, L. L. Summers..... 670,486
Water elevating wheel, H. H. McAdams..... 670,621
Water heater, portable, A. Redfern..... 670,812
Water trough, stock, J. J. McCourt..... 670,802
Wave and tide motor, E. P. Couture..... 670,537
Weather strip, F. F. McCammon..... 670,801
Welding, electric, J. C. Perry..... 670,808
Wells, removing paraffin from oil, G. L. Ball..... 670,577
Windmill, R. A. Nicholl..... 670,806
Window, C. H. Willits..... 670,488
Window bead fastener, T. O'Shea..... 670,595
Window frame and sash guide, G. O. Smith..... 670,865
Wire drawing machine, E. Granville..... 670,424
Wire weaving machine, E. Mathews..... 670,716
Wool and making same, imitation, W. N. Cornell..... 670,847
Woods, machine for imitating peculiarities of natural, W. N. Cornell..... 670,846
Wool cleaning machine, F. G. Sargent..... 670,643
Wrapper for enveloping and sealing money, etc., W. D. Wright..... 670,751

DESIGNS.

Binding skirt, J. Jasper..... 34,299, 34,300
Binding, skirt, C. Seidel..... 34,298 to 34,303
Bottle stopper, E. Davin..... 34,273
Box blank, E. L. Czarniecki..... 34,276
Brick or tile, B. Jacquart..... 34,284, 34,285
Buckle, C. Knothe..... 34,266
Buckle member, belt, A. Holmes..... 34,265
Buckle tongue, belt, A. Holmes..... 34,264
Car replacer, E. Showalter..... 34,291
Carbon anode, M. Mauran..... 34,277
Caster housing, H. B. Ruggles..... 34,282
Chart case, J. H. Carver..... 34,259
Clasp for package fasteners, F. Bailey..... 34,263
Coffee making receptacle, Phillips & Klugmann..... 34,271
Cup or similar article, C. J. Ahrenfeldt..... 34,268
Fabric, D. J. Seaman..... 34,301 to 34,303
Fly catcher, M. C. Lloyd..... 34,278
Game counting books, back for, E. Edwards..... 34,253
Head rest, C. F. Davidson..... 34,290
Hub flange, C. Minshall..... 34,289
Kettle or hot scraper, G. Hoffman..... 34,272
Latch, gate, G. B. Howland..... 34,279
Legs, knee member for artificial, G. W. Farrier..... 34,275
Pencil holder, Dubravsky & O'Leary..... 34,262
Pictures, etc., frame for, E. Oldenbusch..... 34,260
Pipe main fitting, C. Phelps..... 34,281
Plate or similar article, C. J. Ahrenfeldt..... 34,269
Railways, track or way for amusement, E. J. Morris..... 34,293
Range or cooking stove, Anthony & Beattie..... 34,286
Sash lock cam, W. Monroe..... 34,280
Sewing machine cabinet, Abramson & Person..... 34,287
Skylight cap or cover, C. E. Holland..... 34,284
Sole, boot or shoe, F. L. Varney.....

"Star" Lathe Foot and Power Screw Cutting
Automatic Cross Feed
FOR FINE, ACCURATE WORK
Sent for Catalogue B.
SENECA FALLS MFG. CO.
695 Water Street,
Seneca Falls, N. Y., U. S. A.

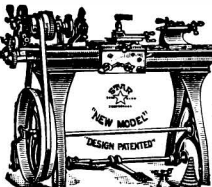

ELECTRIC AUTOMOBILE. — DIRECTIONS, with many illustrations, for making a complete machine from two bicycles are given in SUPPLEMENT No. 1195. The motor and battery are also treated in detail. Price 10 cents. For sale by Munn & Co. and all newsdealers.

ENGINE & FOOT LATHES MACHINE SHOP OUTFITS TOOLS AND SUPPLIES
SEBASTIAN LATHE CO. 200 CULVER ST. CINCINNATI, O.

There is never any question about the quality of a
B. F. BARNES UPRIGHT DRILL.
The tool here illustrated is our 20-inch Drill, and we guarantee it to drill up to 1 inch in steel and 1 1/2 inch in cast iron at a good gait and without strain. We build larger sizes and will be glad to send full data on our entire line to interested people.
B. F. BARNES CO., Rockford, Ill.



Water Emery Tool Grinder
Has no pumps, no valves. No piping required to supply it with water. Always ready for use. Simplest in construction, most efficient in operation.
Send for catalogue and prices.
W. F. & JNO. BARNES CO.
1999 Ruby St., Rockford, Ill.



PHYSICAL AND SCHOOL APPARATUS . . . INDUCTION COILS for experiments in X rays and other electrical work.
Catalogue Free.
E. S. RITCHIE & SONS, BROOKLINE, MASS



Gold Stocks Free!
Just to introduce our big western weekly mining paper (7th year) we will send a block of 5 shares full paid and non-assessable in a Cripple Creek Gold Mine Free. You must send us 50c. cash or stamps for a 6 months' trial sub. to our illustrated weekly paper. Clubs of 5 or more 40c. each. Full mining news. Certificates sent by return mail issued to you. Cripple Creek is a world-beater. Address **ROCKY MOUNTAIN MINER (Inc.)**, Denver, Colo.

MAXIMUM POWER—MINIMUM COST.
If you use a pump for beer, lard, acids, starch, petroleum, brewer's mash, tanner's liquor, cottonseed oil or fluids, hot or cold, thick or thin you want to get the **TABER ROTARY PUMP** which does the most work at the least expense. Simply constructed. Can be run at any desired speed. Perfectly durable. All parts are interchangeable. Needs no skilled workman. Detects guaranteed. Catalogue free.
TABER PUMP CO., 32 Wells St., Buffalo, N. Y., U. S. A.

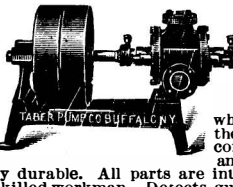

THE JOHNSON ROTARY PUMP.
Simple of construction, positive in action, easy and quiet in operation. Especially adapted to pumping soap, oil, sugar, lard, glucose, acids, starch, kerosene, kerosene, corn and water, malt, etc. Large sizes for irrigation. Made as a belt or steam pump, or combination, or operated by electric motor or gasoline engine. Manufactured by **DAVIS-JOHNSON CO.**, Station V, CHICAGO, ILL. James H. Robley, Agent, 95 Liberty St., N. Y. City.

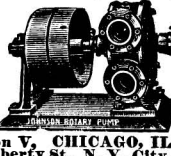

ARMSTRONG'S PIPE THREADING AND CUTTING-OFF MACHINES
Both Hand and Power. Sizes 1 to 6 inches. Water, Gas, and Steam Fitters' Tools, Hinged Pipe Vises, Pipe Cutters, Stocks and Dies universally acknowledged to be THE BEST. Send for catalogue. **THE ARMSTRONG MFG. CO.**, Bridgeport, Conn.

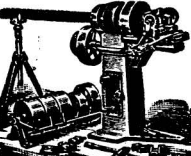

WORKS LIKE A CHARM.
Perfect satisfaction is experienced using our No. 5, 6 or 9 Hand Pipe Threading and Cutting Machines. Crank or ratchet power. Gears housed from dust. Chasers set by graduation to any size, can be released from threading while in motion, opened to permit pipe being cut, and instantly closed.
Send for Free Catalogue to **The Merrell Manufacturing Co.**, 501 Curtiss Street, Toledo, Ohio.



AUTOMOBILE STEAM BOILERS
These Boilers are made of fire box steel, which has a tensile strength of 55,000 pounds. A double butt strap seam is used. The bottom end of shell is flanged to take flat head. This flange also takes care of difference in expansion between shell and copper tubes. Each boiler is tested to 600 pounds C. W. P. Can also furnish boilers with seamless cold drawn shell.
FRANK MILNE, - - - EVERETT, MASS.

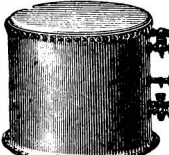

HOW TO MAKE AN ELECTRICAL Furnace for Amateur Use.—The utilization of 110 volt electric circuits for small furnace work. By N. Monroe Hopkins. This valuable article is accompanied by detailed working drawings on a large scale, and the furnace can be made by any amateur who is versed in the use of tools. This article is contained in **SCIENTIFIC AMERICAN SUPPLEMENT, No. 1182**. Price 10 cents. For sale by Munn & Co., 361 Broadway, New York City, or by any bookseller or newsdealer.

THE "QUEEN" DRAWING PENS. SCIENTIFICALLY SHARPENED.
All Queen Pens are sharpened by experts who have had many years' experience in making and sharpening Drawing Pens. Only the finest English Steel is used in the Queen Pens, and they are hand-made and carefully tempered by our improved process. **QUEEN & CO., Inc.**, Mathematical Engineering Scientific Instrument Makers, 1010 Chestnut St., Philadelphia.

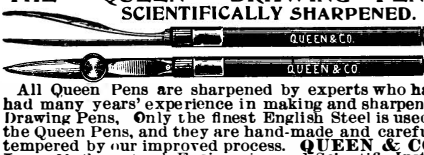

MORROW COASTER BRAKE.
FITS ANY CYCLE 100,000 IN USE
ADDS PLEASURE AND SAFETY—ALL DEALERS SELL THEM.
RIDE 50 MILES—PEDAL ONLY 35. ECLIPSE MANUFACTURING CO., BOX X, ELMIRA, N. Y.
SEND FOR BOOKLET.



A Watched Pot that Boils.
The "Khotal" Blue Flame Oil Stove generates gas from common kerosene and develops heat so rapidly that it will boil a quart of water in two minutes. Will cook anything and can be regulated to any desired degree of heat. It has no wick and no asbestos substitute. It is strong, durable and absolutely safe. A child can operate it.



THE "KHOTAL" Blue Flame Oil Stove
For Home or Camp or Yacht.
Costs little to buy and little to run. The combustion is perfect; no smoke, no smell, no soot deposit on pots and pans. Picture shows smallest size, 8 in. high, weight 5 1/2 lbs. Price \$3.75. Made in sizes large enough to cook a course dinner. Write for free illustrated book G.
THE HYDROCARBON BURNER CO., 197 Fulton Street, New York.

NICKEL AND Electro-Plating Apparatus and Material.
THE Hanson & Van Winkle Co., Newark, N. J., 136 Liberty St., N. Y., 30 & 32 Canal St Chicago.

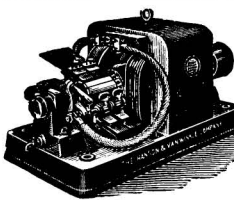

THE HARRISON CONVEYOR—Electric Light and Power Station Equipment, Industrial Railways, Overhead Cable Systems, Coal and Ash Conveyors, etc., Eccentric Shaking Standard Scales, Howe Gas and Gasoline Engines. For catalogue and prices, address the manufacturers.
BORDEN & SELLECK CO., 48-50 LAKE STREET, CHICAGO, ILL.

HERCULES WIRE ROPE
And all kinds of WIRE ROPE, Manila, Sisal, Blocks, etc.
Branch Offices: 92 Centre St., New York. 47-49 So. Canal St., Chicago, Ill.
A. LESCHEN & SONS ROPE CO. MANUFACTURERS OF LESCHEN CO.'S PATENT AERIAL WIRE ROPE TRAMWAY.
The only satisfactory Tramway on the market. ESTIMATES ON APPLICATION.
MAIN OFFICE: 920-922 North First Street, ST. LOUIS, MO.



The "Wolverine" Three Cylinder Gasoline Marine Engine.
The only reversing and self-starting gasoline engine on the market. Lightest engine for the power built. Practically no vibration. Absolutely safe. Single, double and triple marine and stationary motors from 1/2 to 30 H. P.
WOLVERINE MOTOR WORKS, Grand Rapids, Mich.

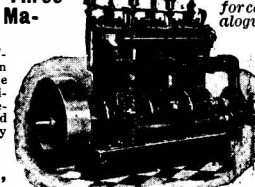

GAS and GASOLINE ENGINES
1-4 and 1 horse power MARINE and STATIONARY.
Built in accordance with the latest practice in Gas Engine design. Also complete set of castings. Write for particulars.
CLIFTON MOTOR WORKS, 233 E. Clifton Ave., Cincinnati, Ohio.



American Sheet Steel Company
Battery Park Building
New York
Manufacturers of all varieties of Iron and Steel Sheets
Black and Galvanized
Plain and Painted
Flat, Corrugated and "V" Crimped
Apollo Best Bloom Galvanized Sheets
W. Dewees Wood Company's Planished Iron
W. Dewees Wood Company's Refined Iron
Wellsville Polished Steel Sheets

ARTESIAN
Wells, Oil and Gas Wells drilled by contract to any depth from 50 to 3000 feet. We also manufacture and furnish everything required to drill and complete same. Portable Horse Power and Mounted Steam Drilling Machines for 100 to 1200 feet. Write us stating exactly what is required and send for illustrated catalogue. Address **PIERCE WELL ENGINEERING AND SUPPLY CO.**, 136 LIBERTY STREET, NEW YORK, U. S. A.



THE MIETZ & WEISS KEROSENE and GAS Engine
burns KEROSENE cheaper and safer than gasoline. Automatic, simple, reliable. No electric battery or flame used. Perfect regulation. Belted or directly coupled to dynamo for electric lighting, charging storage batteries and all power purposes.
Send for Catalogue.
A. MIETZ, 128-138 Mott St., New York. Markt & Co., London, Hamburg, Paris

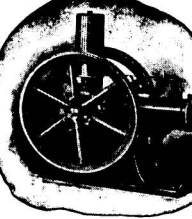

Williams' Shaving Stick
THE ONLY KIND THAT WON'T DRY ON THE FACE
SOLD EVERYWHERE.
Williams' Shaving Stick, 25c.
Genuine Yankee Shaving Soap, 10c.
Luxury Shaving Tablet, 25c.
Swiss Violet Shaving Cream, 50c.
Williams' Shaving Soap (Barbers'), 6 Round Cakes, 1 lb., 40c. Exquisite also for toilet. Trial cake for 2c. stamp.
The only firm in the world making a specialty of SHAVING STICKS.
THE J. B. WILLIAMS CO., Glastonbury, Ct. LONDON PARIS DRESDEN SYDNEY



ACETYLENE GAS AND CARBIDE OF Calcium.—All about the new illuminant, its qualities, chemistry, pressure of liquefaction, its probable future, experiments performed with it. A most valuable series of articles, giving in complete form the particulars of this subject. Details of furnaces for making the carbide, gas generators, gasometers, burners, etc. Contained in **SCIENTIFIC AMERICAN SUPPLEMENT, Nos. 998, 1001, 1007, 1012, 1014, 1015, 1016, 1022, 1035, 1038, 1057, 1064, 1071, 1072, 1082, 1083, 1084, 1085, 1086, 1104, 1124, 1132, 1149 and 1150.** Price 10 cents each, by mail, from this office, and all newsdealers.

Patee Motor Cycles, \$200.
No other make of Motor Cycle can maintain a speed as near equal to this wonderful machine. It is light, strong, serviceable and reliable. Will go every time, any time and all the time. No experiment, no playing, fully guaranteed. Money refunded if not as described. Big trade discount. **WRITE US.**
PATEE BICYCLE CO., Indianapolis, Ind., U. S. A.

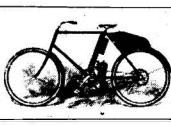

AUTOMOBILE FRAMES
and complete running gears. All parts made from "Drew Steel" may be bent cold, forced or welded. With each set of fittings we furnish Blue Prints of assembled frame. Blue Prints separate \$1.50. Automobile steam engines, compound, 2 1/2", 5" x 4". Send for Catalogue.
SHAEFFER, BUNCE & MARVIN, Lockport, N. Y., U. S. A.

TUBULAR DRIVING LAMP.
IT is the only perfect one. IT will not blow or jar out. IT gives a clear, white light. IT is like an engine head-light. IT throws the light straight ahead from 200 to 300 ft. IT burns kerosene.
Send for book (free).
R. E. DIETZ CO., 60 Laight Street, New York. Mention this paper and get special discount.
— ESTABLISHED 1840.



"HOT BATH IN ONE MINUTE" FOR ONE CENT.
Moses, by the aid of a rod, struck a rock and got cold water. You by the aid of a **Humphrey Crescent Heater** strike a match and get hot water. They require no complicated piping, simply connect with water and gas in your bathroom. Guaranteed.
Write for Booklet.
HUMPHREY MFG. & PLATING CO., Kalamazoo, Mich.



The AUTOSPARKER
The completion of the Gas Engine.
Throw away your batteries and use them no more. The Autosparker saves its cost many times over during the life of your engine. Address **MOTSINGER DEVICE MFG CO.,** Pendleton, Ind., U. S. A. or any gas engine or motor carriage manufacturer.

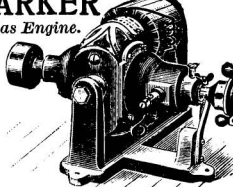

PERFORATED METALS FOR ALL USES. MADE AS REQUIRED.
HARRINGTON & KING PERFORATING CO., CHICAGO.



Columbia AUTOMOBILES
In Sixth Year of Service.
FORTY MILES ON ONE CHARGE.
The extraordinary mileage capacity of the Columbia pleasure vehicles, equipped with new batteries, opens a much more extensive field of service for the perfected electric automobile. Reliable, safe, noiseless, odorless, and operated by man, woman or child, the electric vehicle is the ideal automobile for points of local proximity. Where current cannot be conveniently supplied, we are prepared to furnish estimates for, and erect when desired, simple and automatic plants for charging electric vehicles.
Send for 1901 ILLUSTRATED CATALOGUE.
ELECTRIC VEHICLE CO., HARTFORD, CONN.

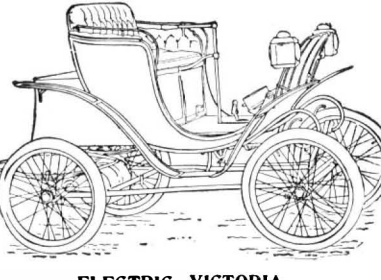

TOOLS OF ALL KINDS
GOODNOW & NIGHTMAN BOSTON
Send 10 cents for 12-page illustrated Catalogue.



BALL BEARING AXLES AND RUBBER TIRES.—A paper read before the Carriage Builders' National Convention, Philadelphia, October, 1894, showing the advantage to be derived from the use of ball bearings and pneumatic tires in road vehicles. Contained in **SCIENTIFIC AMERICAN SUPPLEMENT, No. 492**. Price 10 cents. To be had at this office and from all newsdealers.

MILLS FOR ALL MATERIALS.
OUR BUSINESS IS TO MAKE MACHINERY FOR GRINDING GRAIN, CRUSHING ROCKS AND PULVERIZING ALL HARD SUBSTANCES. WE HANDLE ALL KINDS OF MATERIALS FROM COTTON SEED TO ROOTS AND HERBS. BY AN UNEXCELLED PROCESS, IF YOU WANT ANY KIND OF A MILL OR GRINDING MACHINE, COME TO US AND YOU WILL GET THE BEST AND STILL SAVE MONEY.
ESTIMATES FREELY FURNISHED.
SPROUT, WALDRON & CO. MUINCY, PA.
SEND FOR CATALOG NO. 4.



250 Poultry Pictures

Illustrating every phase of poultry raising and 224 pages of matter telling how, when and what. That and much more is in our "Profitable Poultry Keeping in all its Branches." Tells also about the warranted for 10 years Cyphers Incubator, which is guaranteed to outlast any other incubator, or money refunded. Book for 10c in stamps. Circulars free. Address nearest office. Ask for book 134 CYPHERS INCUBATOR CO., Boston, Mass. Weyland, N. Y. Chicago, Ill.

A Tool Inventory

so comprehensive that it includes most every tool at present used by all trades and professions is **Montgomery & Co.'s Tool Catalogue** a book of 510 pages, illustrated, well printed, pocket size, and mailed to any address on receipt of 25 cents. **MONTGOMERY & CO., 105 Fulton St., N. Y. City.**

Acetylene Gas Lighting

Reduced to the most Efficient, Safest, Simple and Economical Use. We guarantee our machines perfectly automatic in action, to extract all the gas from the carbide, and absolutely no over production or loss of gas. Approved by the various Boards of Fire Underwriters. Standard sizes 10 to 150 lights. Exclusive territory given to responsible agents. Correspond with **NIAGARA FALLS ACETYLENE GAS MACHINE CO., Niagara Falls, N. Y. and Canada.**

VAJEN'S NEW IMPROVED HEAD PROTECTOR The only device with which all harmful atmospheres can be entered and absolute comfort sustained for a long period. No encumbrance. Organs exercise their functions naturally. Wearer breathes cool, fresh air continually. Send for catalogue. Manufactured by **THE VAJEN-BAD-R CO., 120 N. Penn St., Indianapolis, Ind.**

Acetylene Gas Burners. Schwarz Perfection Lava Burner. Highest awards in all Acetylene Expositions. Made of one piece of lava. Are faultless and every one tested and guaranteed. **NO** Blowing. Sole Agents for Perfect Alignment. U. S. and Canada. **M. KIRCHBERGER & CO., 50 Warren Street, New York.**

Telephones, for Interior, Short Line, Intercommunicating and Hotel Work. Write us for prices, catalogue, etc., with testimonials and references. Estimates cheerfully furnished. Agents wanted. **THE SIMPLEX INTERIOR TELEPHONE CO., 431 Main St., Cincinnati, Ohio.**

SENSITIVE LABORATORY BALANCE. By N. Monroe Hopkins. This "built-up" laboratory balance will weigh up to one pound and will turn with a quarter of a postage stamp. The balance can be made by any amateur skilled in the use of tools, and it will work as well as a \$125 balance. The article is accompanied by detailed working drawings showing various stages of the work. This article is contained in **SCIENTIFIC AMERICAN SUPPLEMENT, No. 1154.** Price 10 cents. For sale by **MUNN & Co., 361 Broadway, New York City,** or any bookseller or newsdealer.

"NEW GEM" SAFETY RAZOR IMPOSSIBLE TO CUT THE FACE. BEST AND SIMPLEST SAFETY EVER DEvised. NO EXPERIENCE REQUIRED. WE GUARANTEE AND KEEP THEM SHARP FOR ONE YEAR. **PRICE \$2.00 POSTPAID.** SEND FOR ILLUSTRATED PRICE LIST. **THE GEM CUTLERY CO., 37 READE ST. NEW YORK.**

A SAVINGS BANK in the West ordered as an investment for **SAVINGS' FUNDS 2,500 SHARES OF THE STOCK OF THE STANDARD SMELTING AND REFINING COMPANY** AT 40 CENTS PER SHARE, the price at which we are now offering the first issue of the full paid non-assessable stock of the Company. **Union Consolidated Oil Co.** stock is now **17 1/2 CENTS PER SHARE** and we are offering for a short time only the **2 Stocks at 55 Cents Per Share.** The Consolidated Oil Co. now have producing properties that are earning **Over 2 per cent.** Monthly on all of the stock sold to date. **Monthly Dividends Will Begin in May** and the Standard Smelting and Refining Co. will easily earn **20 per cent. Per Annum** as soon as the plant is in operation, in August. **Prospectuses of the Smelter and Oil Companies, order blank, etc., and also booklets of new mines and dividend payers, special combination plan, latest reports from the properties, and full particulars mailed free to anyone interested.** **DOUGLAS, LACEY & CO., BANKERS AND BROKERS, Members New York Consolidated Stock Exchange, 66 Broadway and 17 New St., New York.** BRANCHES: Cleveland, "The Cuyahoga" Building. Boston, "The International Trust Co." Building. Philadelphia, "The Betz" Building. Chicago, "The Fisher" Building. St. Louis, "The Security" Building. Kansas City, "The Heist" Building. St. John, N. B., "The McLaughlin" Buildings. London, Eng., "The Trafalgar" Buildings.

WILL SHIP C. O. D. FOR \$25.00 WITH PRIVILEGE OF EXAMINATION. FREIGHT PREPAID TO YOUR STATION. **"THE WILLARD STEEL RANGE"** Has 6 8-in. lids, oven 17x21x12, 15-gallon reservoir and warming closet, lined throughout with asbestos, burns wood or coal. This special inducement is offered for a limited time only. Mention this paper. **WM. G. WILLARD, Manufacturer, 619 and 621 N. 4th St., St. Louis, Mo.**

ELEVATING - CONVEYING POWER TRANSMISSION MACH'Y COAL WASHING MACHINERY **Coal Mining Machines** ELECTRIC MINE LOCOMOTIVES POWER COAL DRILLS COAL HANDLING MACHINERY **The JEFFREY MFG. CO., Columbus, O.**

GRAND PRIZE, PARIS, 1900. HIGHEST AWARD POSSIBLE. **NO DIRTY HANDS** WITH THE SMITH PREMIER TYPE CLEANING DEVICE. IT ELIMINATES THAT OBJECTIONABLE FEATURE SO COMMON TO OTHER TYPEWRITERS AND KEEPS BOTH THE OPERATOR AND THE TYPE FREE FROM DIRT. **THE SMITH PREMIER TYPEWRITER CO., SYRACUSE, N. Y. U.S.A.** AN IMPROVEMENT AFFIXED ONLY TO SMITH PREMIER TYPEWRITERS. SEND FOR CATALOGUE.

GASOLINE MOTOR CASTINGS For MARINE, VEHICLE and BICYCLE MOTORS, with Working Drawings. **LOWELL MODEL CO., 22 Wiggins St., Lowell, Mass.**

The Improved BELL ODOMETER APPLIED TO YOUR AUTOMOBILE OR CARRIAGE will give you the exact distance traveled, and announce each mile passed by the stroke of a bell. Send for Descriptive Circular S. **S. H. DAVIS & CO., Cor. Portland & Sudbury Sts., Boston, Mass.**

10 DAYS' TRIAL DAUS' TIP TOP to responsible parties. DUPLICATOR prints 100 copies in black from one pen written original and 50 copies from typewriter. It takes an expert to tell the duplicates from the original. **FELIX DAUS DUPLICATOR CO., 5 Hanover St., New York**

DICKERMAN'S DURABLE DESKS Don't buy until you get our catalogue—100 pages of money saving values. **AMERICAN STORE STOOL CO., 33 Howard St., New York**

Vanduzen Steam Jet Pumps Especially serviceable for Brickyards, Quarries, Coffey Dams, Mines, Tube Wells, Paper Mills, Breweries, Tanneries, &c. Will elevate muddy and sandy water without injury to pump. Simple, portable, durable. Ten sizes. Write for catalog 100. **THE E. W. VANDUZEN CO., CINCINNATI, O.**

Patton's Sun Proof Paints are guaranteed to give beauty and protection to a house for five years. Send for the free book of paint knowledge. Liberal inducements to dealers. **PATTON PAINT CO., 227 Lake St., Milwaukee, Wis.**

The No. 4 YOST WRITING MACHINE The distinctive features of the Yost Machine, permanent alignment, direct inking, beautiful work, strength, simplicity, and durability are shown in perfection in the No. 4 Model. **Yost Writing Machine Co., NEW YORK CITY. LONDON, ENG.**

The Typewriter Exchange 1 1/2 Barclay St., NEW YORK 124 La Salle St., CHICAGO 38 Bromfield St., BOSTON 817 Wyandotte St., KANSAS CITY, MO. 209 North 9th St., ST. LOUIS, MO. 432 Diamond St., PITTSBURGH, PA. 3 West Baltimore St., BALTIMORE, MD. 536 California St., SAN FRANCISCO, CAL. We will save you from 10 to 50% on Typewriters of all makes. Send for Catalogue.

Perfection Air Mattresses FOR CAMP-YACHT-HOME-HOSPITAL. NON-ABSORBENT, HYGIENIC, ODORLESS. When deflated can be rolled into small package for storage or transportation. Send for Illustrated Catalogue with Prices. **Mechanical Fabric Co., PROVIDENCE, R. I.**

THE NEW BRISTOL COUNTER Registers an accurate account of work done on printing presses, grain tallies, weighing, measuring and other automatic machines. Counts up to 1,000,000 and repeats automatically. Simple, accurate, durable. Special counters to order. Send for circular. **C. J. ROOT, Bristol, Conn., U. S. A.**

SAVE YOUR FUEL! If you feed water to a steam boiler at exactly the same rate as it is evaporated you will save a deal of fuel. Every engineer and fireman knows this and he also knows that the **CLARK REGULATOR ALARM COLUMN** does this automatically without variation or attention, saving fuel, time, repairs and worry applicable to all types of boilers. Write for our book "Practical Economy for Steam Users," and let us tell you more about it. **THE CLARK BROS. CO., Vicksburg, Mich.**

THE ELECTRIC HEATER.—A VALUABLE paper, with working drawings of various forms of the electrical heaters, including electric soldering iron, electric pad for the sick, etc. 6 illustrations. **SCIENTIFIC AMERICAN SUPPLEMENT 1112.** Price 10 cents. For sale by Munn & Co. and all newsdealers.

ALTERNATING CURRENT MOTORS. If you only have alternating current available send for description of our A. C. motors. They start up under full load, take normal current at starting and are fully as efficient and economical to run as any direct current machine of the same size. In fact, they are less complicated and not liable to get out of order. Send for bulletin 102-X for full description of these machines. **The Holtzer-Cabot Electric Co. Boston (Brookline), Mass.**

PROSPECTIVE BOAT BUYERS. By constructing your boat from a set of my **Boat Building Materials** more than one-half the boat factory's price can be realized. Also economize freight 500 per cent. Launches, Sail and Row Boats, Gasoline Engines. Catalog free. **FRED MEDART, 3545 DeKalb St., St. Louis, Mo.**

HOLD ON THERE! Send 3c. for catalog of **Monarch Marine Gasoline Engines,** 3 1/2 to 45 H.P. \$200 up. **Grand Rapids Gas Engine & Yacht Co., Grand Rapids, Mich.**

ROTARY PUMPS AND ENGINES. Their Origin and Development.—An important series of papers giving a historical resume of the rotary pump and engine from 1588 and illustrated with clear drawings showing the construction of various forms of pumps and engines. 38 illustrations. Contained in **SUPPLEMENTS 1109, 1110, 1111.** Price 10 cents each. For sale by Munn & Co. and all newsdealers.

FOR VEHICLE AND MARINE PURPOSES. Nothing better or more economical than our four-cylinder motors. Possess every known point of excellence. Durable in every part. Detachable igniters, heavy bearings and shifting spark, water-jacketed head, runs any speed from 100 to 1500 per minute. 4 1/2 to 10 H.P. Fully guaranteed. Ground joints throughout. **Buffalo Gasoline Motor Co., Buffalo, N. Y., U. S. A.** Apply for Catalogue.

The Deadly Faucet! From it comes the germ-laden water carrying with it all the elements of disease, but if you use **The Berkefeld Filter** the water will be thoroughly purified in passing through the cylinders of **Infusorial Earth** which retains every atom of solid matter. Easy to clean. Yields a gallon of pure water in 4 minutes. **BERKEFELD FILTER CO., 2 Cedar St., New York.**

GERE GASOLINE ENGINES SIMPLEST BOAT ENGINES MADE **CABIN AND OPEN BOATS** ENGINE CASTINGS, BOAT FRAMES **GEORGE YACHT LAUNCHING, GRAND RAPIDS, MICHIGAN.**

OUR SPECIALTY: Knock-Down Boats of any description. **AMERICAN BOAT & MACHINE CO., ROW, SAIL AND PLEASURE BOATS, Marine Station, ST. LOUIS, MO.**

OUR MARINE MOTORS ARE GUARANTEED TO GIVE SATISFACTION. Durable in Construction and Easy and Safe in Operation. Send for Catalogue and investigate our claims. **TRUSCOTT BOAT MFG. CO., St. Joseph, Mich., U. S. A.**

THE ORIGINAL AND GENUINE ::: Rubber Goods. Perfectly imitate linen. Are durable and keep white. They go to all parts of the Globe. Write for Catalog. We want Agents everywhere. M'd only by **Windsor Collar & Cuff Co., Windsor, Conn.**

RUBBER STAMP MAKING.—THIS article describes a simple method of making rubber stamps with inexpensive apparatus. A thoroughly practical article written by an amateur who has had experience in rubber stamp making. One illustration. Contained in **SUPPLEMENT 1110.** Price 10 cents. For sale by Munn & Co. and all newsdealers.

THE WILLIAMS Pneumatic Pulley Double the grip of an ordinary pulley. **M. F. WILLIAMS & SONS, ST. LOUIS, MO., U. S. A.**

ACETYLENE DO YOU KNOW that the most light, least trouble, greatest comfort can be secured by using good burners. The best burner is **D. M. STEWARD'S WONDER.** Write, enclosing 25 cents, for sample. **STATE LINE MFG. CO., Chattanooga, Tenn., U. S. A.**

"The Reeves" Variable Speed Countershaft Powerful, Responsive, Durable and Efficient. for securing any speed without change of belt or loss of time. Especially adapted for all kinds of Iron-working Machinery, Iron Lathes, Planers, Boring Mills, Shapers, etc.; Cement Machinery, Experimental Machinery—in fact all kinds of machinery requiring a change of speed. With it a large increase and a better grade of work can be produced. Send for handsomely illustrated catalogue "S. A." free. **REEVES PULLEY CO., COLUMBUS, IND., U. S. A.**

What Do You Want To Buy? We can tell you where to buy anything you want. Write us for the addresses of manufacturers in ANY line of business. **Novelties, Special Tools, Machinery, Equipments, New Patent LABOR SAVING DEVICES.** **MUNN & CO., Publishers of the SCIENTIFIC AMERICAN, 361 BROADWAY, NEW YORK.**

A Line to Workers who are Drifting

Write for free copy of our book: **SALARIED POSITIONS for LEARNERS**

It tells how you can support yourself while learning your chosen profession. 250,000 students and graduates in Mechanical, Civil, Electrical Engineering, Architecture, Drawing, Designing, Book-keeping, etc.

International Correspondence Schools, Box 942 Scranton, Pa.

WEBSTER'S INTERNATIONAL DICTIONARY

NEW EDITION JUST ISSUED

NEW PLATES THROUGHOUT

Now Added **25,000 NEW WORDS**, Phrases, Etc.

Rich Bindings • 2364 Pages • 5000 Illustrations

Prepared under the supervision of W. T. Harris, Ph.D., LL.D., United States Commissioner of Education, assisted by a large corps of competent specialists.

BETTER THAN EVER FOR HOME, SCHOOL, AND OFFICE.

Also Webster's Collegiate Dictionary with Scottish Glossary, etc.

"First class in quality, second class in size." *Nicolas Murray Butler.*

Specimen pages, etc., of both books sent on application.

G. & C. MERRIAM CO., Publishers, Springfield, Mass., U. S. A.

ICE MACHINES, Corlies Engines, Brewers' and Bottlers' Machinery, THE VILTER MFG. CO., 829 Clinton Street, Milwaukee, Wis.

MODELS & GEARS CATALOGUES FREE UNION MODEL WORKS, 193 CLARK CHICAGO.

SHORTHAND BY MAIL. Pioneer home course. *Catalogue and First Lesson Free.* Fotts Shorthand College, Box 33, Williamsport, Pa.

1/2 H. P. GAS ENGINE CASTINGS Materials and Blue Prints. Write for Catalogue 9. PARSELL & WEED, 123-131 W. 31st Street, New York.

SALE IN EUROPE, particularly in France, of patented American Machines and Industrial Apparatus, and of patented American Inventions. L. Simon, Civil & Mechanical Engineer, Troyes, France.

FOR SALE. Valuable patent (recent) bottle stopper for beer, etc. Only sold on account of patentee's age. Those meaning business may have photograph. Address **G. J. BUCHLER**, 2411 North 7th Street, Philadelphia, Pa.

D'AMOUR & LITTLEDALE MACHINE CO. 130 WORTH ST., NEW YORK. PATTERN AND MODEL MAKERS.

ANY BICYCLE RIDER may and **ALL REPAIRERS** do need out 1901 A. J. Hanger. If you have a used-up hanger to replace; if you have frames with odd-size brackets; if you want a hanger gear; Write us and find out all about the A. & J. Hanger. We send the complete set all ready to go into your frame. No bother brazing or re-enameing. We can fit any frame. **THE AVERY & JENNESS CO.,** 30 W. Washington St., Chicago, Ill.

MODELS & EXPERIMENTAL WORK. Inventions developed. Special Machinery. E. V. BAILLARD, Fox Bldg., Franklin Square, New York.

D. L. HOLDEN 14 SOUTH BROAD ST. PHILADELPHIA PA. SOLE MANUFACTURER **REGALED ICE MACHINES** SEE FIRST PAGE SCIENTIFIC AMERICAN SEPT. 2, 1899.

ELECTRICAL ENGINEERING TAUGHT BY MAIL.

Write for our Free Illustrated Book. **"CAN I BECOME AN ELECTRICAL ENGINEER?"**

We teach Electrical Engineering, Electric Lighting, Electric Railways, Mechanical Engineering, Steam Engineering, Mechanical Drawing, at your home by mail. Institute indorsed by Thos. A. Edison and others.

ELECTRICAL ENGINEER INSTITUTE, Dept. A, 240-242 W. 25th St., New York.

FREE MECHANICAL ENCYCLOPEDIA.

No mechanic should be without it. Sent postpaid on request.

S. S. WILLIAMSON, Publisher, 1148 Betz Building, Philadelphia, Pa.

Your scale of wages depends on your efficiency.

FREE SCHOLARSHIP

The Trustees of the American School of Correspondence will award a limited number of Free Scholarships in Mechanical, Electrical, Marine, Stationary, and Locomotive Engineering, including a complete course in Mechanical Drawing. Application blank on request.

American School of Correspondence, Boston, Mass.

Would You Become a Man of Mark?

Would you possess the capacity that directs affairs? Would you develop the power that dominates men; the force that controls their minds? In all walks of life these faculties measure the difference between success and failure. They are to be traced to one mental characteristic—**Personal Magnetism.** It is this well-nigh indefinable something that makes a man irresistible; that enables him to compass all difficulties—to surmount all obstacles. It is this mental energy that causes him to surpass his fellow-men in the pursuit of fame, fortune, happiness. With the consciousness of the power of Personal Magnetism attained, comes ability to make friends, inspire confidence, win affections. You can embrace opportunities, gain social position, achieve business success. You can become a great power for good in the community in which you live.

"THE WONDERS OF PERSONAL MAGNETISM AND HYPNOTISM" is the title of a scientific treatise which tells you precisely how to acquire this marvelous influence. It is a comprehensive work by the eminent authority, Dr. X. La Motte Sage, A.M., Ph.D., LL.D., graphically written, profusely illustrated, admirably executed. It reveals wonderful secrets and contains startling surprises. It is free to you for the asking. This offer is absolutely genuine and without conditions. Send your name and address and receive the book by return mail without expenditure. It has brought success to thousands who have sent us such testimonials as these:

Rev. J. C. QUINN, D.D., Ph.D., Pittsfield, Ill., says: "Your treatise is a revelation. It is far in advance of anything of the kind that I have ever seen."

Mrs. R. C. YOUNG, No. 312 Indiana St., Lawrence, Kan., writes: "Your instructions are worth more than all the previous reading of my life. The book is simply grand."

Write at once to

NEW YORK INSTITUTE OF SCIENCE, Dept. PT 13, ROCHESTER, N. Y.

THE AUTO-CARBURETTOR

made upon a new principle furnishes a reliable explosive mixture. Easy ignition and greatest expansion. No pump required. Especially adapted to automobile and cycle motors. Our customers say it is the best Carburettor in the market. We make also the **Register Valve** for controlling the flow of gasoline or other fluids. Write us for prices and booklet on Carburetors. Gasoline and Steam Engines and Automobiles built to order and repaired.

The Avery & Jenness Co., 30 W. Washington St., Chicago

DO YOU KEEP POULTRY?

If you do, and wish to breed chickens fast and make money you ought to get a **NOXALL INCUBATOR AND BROODER.**

Made in all sizes from 50 egg up to 800 egg. Steel case, finished in handsome cherry or oak. When heat rises above 108°, it is taken directly away from incubator. Eclipse Incubator, 100 egg, \$9.00; 200 egg, \$12.00; Eclipse Incubator and Brooder combined, 50 egg, \$7.50; 100 egg, \$11.00; 200 egg, \$17.00. Catalogue 4 cents.

NOXALL INCUBATOR & BROODER CO., Quincy, Ill.

50 YEARS' EXPERIENCE

PATENTS

TRADE MARKS DESIGNS COPYRIGHTS & C.

Anyone sending a sketch and description may quickly ascertain our opinion free whether an invention is probably patentable. Communications strictly confidential. Handbook on Patents sent free. Oldest agency for securing patents. Patents taken through Munn & Co. receive special notice, without charge, in the **Scientific American.**

A handsomely illustrated weekly. Largest circulation of any scientific journal. Terms, \$3 a year; four months, \$1. Sold by all newsdealers.

MUNN & Co., 361 Broadway, New York Branch Office, 625 F St., Washington, D. C.

Apply a Patch to a G & J Tire

Putting a patch on a G and J Tire is as simple as putting a patch on a pretty face. They are the safest, fastest, easiest and most durable tires made.

G & J TIRE CO., Indianapolis Ind.

MORAN FLEXIBLE JOINT for Steam, Air or Liquids. Made in all sizes to stand any desired pressure.

Moran Flexible Steam Joint Co., Inc'd., 149 East 3d St., LOUISVILLE, KY.

A VALUABLE PATENT. Any individual or company wishing to invest a few thousand dollars in the purchase of an interest in a patent on a machine costing but little to build, and being of universal application to the needs of the inhabitants of every town in the United States, and having no competition, write to **JOHN M. JONES, Palmyra, New York.**

BICYCLES BELOW COST

5000 High Grade guaranteed 1901 Models \$10-\$18 with best equipments, to \$20

'99 & '00 MODELS, \$7 to \$12 Good Second Hand Wheels, \$3-\$8 best makes in perfect riding order. Must be closed out.

We ship anywhere on 10 days trial without a cent in advance.

EARN A BICYCLE distributing catalog for us. You can make money as our agent. Write at once for our Bargain List and Special Offer.

MEAD CYCLE CO., Dept. 62 L Chicago.

A Book for Every American Engineer

AMERICAN Engineering Competition

The articles which make up this volume appeared originally in the London Times.

They are the work of a British engineer who visited this country for the purpose of studying our industrial progress.

They show our advance over England along those very lines in which she has long been pre-eminent.

The publication of these articles has aroused the greatest apprehension among British manufacturers.

8vo. Cloth, \$1.00.

ACETYLENE APPARATUS

Acetylene number of the SCIENTIFIC AMERICAN SUPPLEMENT, describing, with full illustrations, the most recent, simple or home-made and commercial apparatus for generating acetylene on the large and small scale. The gas as made for and used by the microscopist and student; its use in the magic lantern. The new French table lamp making its own acetylene. Contained in SCIENTIFIC AMERICAN SUPPLEMENT, No. 1057. Price 10 cents prepaid by mail. For other numerous valuable articles on this subject we refer you to page 21 of our Supplement Catalogue, sent free to any address.

MUNN & Co., 361 Broadway New York.

EMPIRE GEARLESS TRANSMISSIONS FOR AUTOMOBILES & TRICYCLES

EMPIRE MOTOR WKS., 888 WASHINGTON ST. BUFFALO N. Y.

FOR SALE. Valuable patent (recent) bottle stopper for beer, etc. Only sold on account of patentee's age. Those meaning business may have photograph. Address **G. J. BUCHLER**, 2411 North 7th Street, Philadelphia, Pa.

D'AMOUR & LITTLEDALE MACHINE CO. 130 WORTH ST., NEW YORK. PATTERN AND MODEL MAKERS.

ANY BICYCLE RIDER may and **ALL REPAIRERS** do need out 1901 A. J. Hanger. If you have a used-up hanger to replace; if you have frames with odd-size brackets; if you want a hanger gear; Write us and find out all about the A. & J. Hanger. We send the complete set all ready to go into your frame. No bother brazing or re-enameing. We can fit any frame. **THE AVERY & JENNESS CO.,** 30 W. Washington St., Chicago, Ill.

MODELS & EXPERIMENTAL WORK. Inventions developed. Special Machinery. E. V. BAILLARD, Fox Bldg., Franklin Square, New York.

THE PRINCIPAL CHARACTERISTICS of the Nickel Plate Road which make it the popular line for the traveling public are competent train service, fine roadbed and courteous employees. The Nickel Plate Road is the Short Line between Buffalo and Chicago. The Great Pan-American Exposition this summer will present unusual attractions. The Nickel Plate Road will be in position to accommodate this travel with safety, speed and comfort. Write, wire, phone or call on F. J. Moore, General Agent, 291 Main St., Buffalo, N. Y.

FOR SALE

1 Upright Compound Engine 15" x 28" x 36" in good order. Has been thrown out of service by a direct-connected generating engine owing to electric transmission.

OTIS ELEVATOR COMPANY, Yonkers, N. Y.

BACKUS GAS AND GASOLINE ENGINE

Simple. Economical. Durable. Suitable for all kinds of work.

Backus Water Motor, cheapest power known.

Write for circular and prices.

BACKUS WATER MOTOR CO., Newark, N. J., U. S. A.

SPECIAL PRICES 30 Days' Trial. Guaranteed. Double and Combination Beam.

OSGOOD SCALE CO., 355 Central St., BINGHAMTON, N. Y. Catalogue Free. Write now.

PATENTED AND PATENTABLE DEVICES manufactured and introduced. Experimental work of all kinds. Mechanical drawings, samples, models, etc., executed with dispatch and accuracy. I have for sale the best alligator wrench ever invented. L. B. BAKER, Racine, Wis. Reference: Racine banks and business houses or any Commercial Report.

DRIVING A PLEASURE when holding your horse with an **IMPERIAL BIT**, giving 100 per cent more leverage than any other. Any lady can control the most vicious horse. Positive cure for tongue-jolting. Will prevent side pulling and driving on one line. Sent to any address, postpaid, upon receipt of price. In X C plate or imitation rubber, \$1. In fine nickel plate, \$2.

Imperial Bit and Snap Co., 14th Street, Racine, Wis.

NOTICE! RECEIVER'S SALE!

Notice is hereby given that on April 16th, 1901, at No. 47 White Street, in Danbury, Connecticut, there will be offered for sale all the property of the firm of Richards, Lenox & Murphy, consisting of Merchandise, Tools and American and Foreign patents for an esterwax for beer cooler or return beer system. The sale will begin at 2:30 o'clock in the afternoon of said day and continue as long as necessary. **REUBEN B. PEARCE, Receiver.**

LYON & HEALY'S BRASS BAND Own Make

INSTRUMENTS. Indorsed by the great Jules Levy as the best in the world. Big Catalog, 400 illustrations, FREE. Positively the lowest prices on Band Instruments, Uniforms and Supplies of all kinds. Also contains Music and Instructions for New Bands. Lyon & Healy, Manufacturers, 38 Adams St., Chicago. (Lyon & Healy are the largest music house in the world—Editor.)

MECHANICS ENGINERS, Etc. ELECTRICIANS, FIREMEN, Etc. New 40-page pamphlet containing Questions asked by Examining Board of Engineers. **SENT FREE.**

GEO. A. ZELLER, Pub. Room 550, 18 S. 4th St., - St. Louis, Mo., U. S. A.

17 JEWEL adjusted, patent regulator, stem wind and movement. Ladies or Gents Size. **NATIONAL SPECIAL** WARRANTED 20 YEARS. 14K. Gold plate hunting case, elegantly engraved. Fit for a king. No better watch made. Must be seen to be appreciated. Special offer for next 60 days, send your full name and address and we will send this watch C.O.D. with privilege to examine. If found satisfactory pay agent \$5.85 & express charges. A guarantee and beautiful chain & charm sent free with every watch. Write at once as this may not appear again. **NAT'L MFG. & IMPORTING CO., 834 Dearborn St., B420, Chicago, Ill.**

Franklin Square Harper & Brothers New York City

FOR MEN OF BRAINS
Cortez CIGARS
-MADE AT KEY WEST-

These Cigars are manufactured under the most favorable climatic conditions and from the mildest blends of Havana tobacco. If we had to pay the imported cigar tax our brands would cost double the money. Send for booklet and particulars.
CORTEZ CIGAR CO., KEY WEST.

THOROUGH INSPECTIONS
AND
INSURANCE AGAINST LOSS OR DAMAGE TO PROPERTY AND LOSS OF LIFE AND INJURY TO PERSONS CAUSED BY STEAM-BOILER-EXPLOSIONS

HARTFORD, CONN.
HARTFORD STEAM BOILER INSPECTION AND INSURANCE CO.

J. M. ALLEN, PRESIDENT
J. B. PIERCE, SECRETARY
L. BRAINERD, TREAS.

V. B. FRANKLIN, VICE PRESIDENT
F. B. ALLEN, 2ND VICE PRESIDENT
L. F. MIDDLEBROOK, ASST. SECY.

THE PRIDE OF POSSESSION

is pardonable if it's a
WINTON MOTOR CARRIAGE

Users know there is none better, handsomer, or more durable. It is reliable under all conditions. Worth every dollar it costs. Economical in operation. Hydro-carbon (gasoline) system.

PRICE \$1,200.

THE WINTON MOTOR CARRIAGE CO.,
486 Belden Street, Cleveland, Ohio, U. S. A.
EASTERN DEPOT, 150-152 East 58th Street, New York.

The Haynes-Apperson Co.

BUY THE BEST OUR 1901 MODEL



We are the pioneer automobile manufacturers of America. Profit by our experience. We have passed the experimental stage and have something practical to offer. Write for catalogue describing our gasoline system and one, two and three seated carriages.
THE HAYNES-APPERSON CO., KOKOMO, IND.

METHODS AND INSTRUMENTS USED IN ASTRONOMY.—An illustrated description of the telescopes in the Lick and Paris Observatories. 6 illustrations. **SCIENTIFIC AMERICAN SUPPLEMENT 1120.** Price 10 cents. For sale by Munn & Co. and all news-dealers. Send for catalogue.

CHARTER ENGINE USED ANY PLACE BY ANY ONE FOR ANY PURPOSE

FUEL—Gasoline, Gas, Distillate
Stationaries, Portables, Engines and Pumps, Hoisters

State Your Power Needs
CHARTER GAS ENGINE CO., Box 148, STERLING, ILL.



WATERPROOF GLUE

A NEW GLUE which is strictly **WATER-PROOF.** Information and prices supplied by the
CASEIN COMPANY OF AMERICA,
74 JOHN ST., NEW YORK, N. Y.

Colt Carbide Feed ACETYLENE GENERATORS

are endorsed by the U. S. Government, by the State of Pennsylvania, and by all other disinterested authorities

They embody the latest and most approved principles of construction, and are guaranteed by the largest concern engaged in the business to be of perfect workmanship.

Made from the best material by expert mechanics.
ECONOMICAL AND SAFE. EASY OF OPERATION.

J. B. COLT CO., Dept. S.
21 Barclay Street, New York.
146 Franklin Street, Boston.
189 La Salle Street, Chicago.
421 Chestnut Street, Philadelphia.



WALTHAM WATCHES

The best pocket machines for keeping time that it is possible to make.

"The Perfected American Watch", an illustrated book of interesting information about watches, will be sent free upon request.

American Waltham Watch Company, Waltham, Mass.

Are You Selling Machinery?

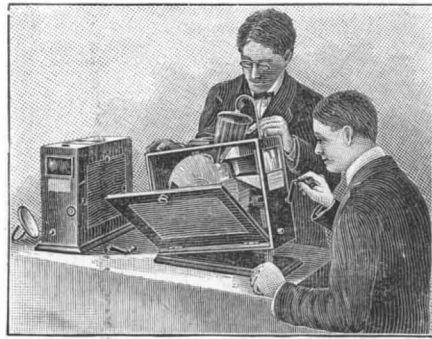

Here is a device which will show by a moving picture your machine in actual operation.

THE COMMERCIAL MUTOSCOPE

Takes the place of expensive demonstrations. Saves hundreds of dollars in the transportation of models and samples. Gives wonderful results in demonstrations before a jury in patent litigation. Now in use by:

- | | |
|--|-----------------------------|
| Hipwood-Barrett Car Fender Co. | Cliff-Guibert Hose-Reel Co. |
| Brown Hoisting & Conveying Machine Co. | American Railway Co. |
| Harrington Rail-Bonding System | The Draper Co. |
| Chicago Pneumatic Tool Co. | Northrup Loonis |
- and many others.

American Mutoscope & Biograph Co. 841 Broadway, New York.

RUST PREVENTED
ON GUNS TOOLS & CYCLES
BY **MANNOCITIN**
C. H. BRESLY & CO. CHICAGO ILL. U.S.A.

Scales All varieties at lowest prices. Best Railroad Track and Wagon or Stock Scales made. Also 1000 useful articles, including Saws, Sewing Machines, Bicycles, Tools, etc. Save Money. Lists Free. **CHICAGO SCALE CO., Chicago, Ill.**

Store or Street Lamps

COST, 1/2 CENT PER HOUR.

The best, clearest and most brilliant lights for store or street are furnished by the

M & M ARC LAMPS

which have 450 candle power and burn from 12 to 15 hours with one filling. They are air-pressure lamps with overhead generators. Every lamp is guaranteed to do all we claim for it. When we say "450 Candle Power," we mean it. Made entirely of brass, heaviest gauge of any gasoline lamp, and durable enough to last fifty years. Is on list of permitted devices of National Board of Underwriters. Non-explosive, no smell, no smoke. Finished in nickel. Handsome in appearance.
ABSOLUTELY PORTABLE.

MARTIN & MOREHEAD,
51 West Washington Street, CHICAGO.



FOR MEN
JAMES MEANS' SHOE

(Trade Mark)

None genuine unless bearing upon the heel the adhesive label of which a fac-simile is here given.

\$2.50

MADE IN MASSACHUSETTS

JAMES MEANS' \$2.50 SHOE.

KNOWN AND APPROVED BY THE PUBLIC FOR 23 YEARS.

SOLD BY LEADING RETAILERS.

Made in a variety of styles and leathers. Sewed. Smooth innersoles.

Made in two weights indicated by (L) or (H) stamped upon the soles. Be sure to buy the weight best suited to your needs.

Distributed at wholesale by
MORSE & ROGERS OF NEW YORK.



Do You Know That Your Razor Has Teeth

Its edge is not a straight, but a serrated line and the finer the teeth the better the razor. Ordinary shaving lathers injure these teeth by invisible corrosion. This is what puts a razor out of order, compelling frequent stropping and honing.

ELECTRO SHAVING LATHER

is a new and scientific improvement in a shaving outfit. It preserves and hardens the delicate teeth of the razor, makes it cut easier, soothes the skin, is easy to make and delightful to use. Send for free folder giving particulars.
F. G. FOWLER & CO., Bridgeport, Conn., U.S.A.



"LIGHT OF ASIA" LAMP

The Smallest Portable Electric Light. **\$2.50**

Unlike all other portable lights, the batteries of the "Light of Asia" Lamp do not deteriorate unless used for a good light. For short intervals, this lamp is unexcelled. The "Light of Asia" Lamp is made with a view to beauty, and is mounted in an aluminum shell covered with fine leather. Weight, 5/8 oz. 3/4 in. diameter. 8 inches long.

Every One Guaranteed.
ELECTRIC CONTRACT CO.,
61 ELM STREET, NEW YORK.



WATCHES!

No advertisement can properly portray the striking effects produced in our watches. They are illustrated in our

BLUE BOOK showing Ladies' Watches in all metals and exquisite enamels; our

RED BOOK showing Men's and Boys' Watches with up-to-date attractive designs. Either Blue or Red Book sent on application.

THE NEW ENGLAND WATCH CO.,
37 & 39 Maiden Lane, New York City, Chicago.
Spreckels Building, San Francisco.



HOT BLAST WATER JACKET FURNACES FOR COPPER ORES.

MATTE from SULPHIDES AT ONE OPERATION.

UNION IRON WORKS,
San Francisco, Ca., U. S. A.

Send for Catalogues.



CRACKS IN FLOORS

are unsightly, unclean and unsanitary. **GRIPPIN'S WOOD, CRACK AND CREVICE FILLER** is the only perfect remedy. A Paste, easily applied, elastic adhesive, and non-sinkable. Dirt and moth proof. Cost about 1/2c. per sq. ft. 5 lbs. will treat an average room. Price 20 cts. per lb. State the kind and condition of wood when ordering, and full instructions will be given. Is also the best filler for open-grained woods.

GRIPPIN MFG. CO., Lock Box L, Newark, New York.
(Enclose stamp for booklet.)



The NATIONAL ELECTRIC VEHICLE

EXCELLENCE

RUNABOUT—Style A.

The lightest practical Electric Vehicle on the market. It embodies every good device found in modern Auto conveyances.

Send ten cents in stamps, for the handsomest and most complete "Auto Book" ever published on the subject of Automobiles.

Illustrated pamphlet mailed free to any address

The National Automobile & Electric Co.
INDIANAPOLIS, IND.
1115 East 22d Street.



"Pocket Kodak Portraiture"

is the title of a daintily printed and instructive booklet about home picture taking, which has just been issued by the Kodak Press. The illustrations are all from the Kodak of

Mr. Rudolf Eickemeyer, Jr.,

and include a number of his most charming studies of child life. Free at the Kodak dealers' or by mail.

EASTMAN KODAK CO.,
Rochester, N. Y.

JESSOP'S STEEL THE VERY BEST FOR TOOLS, SAWS ETC.
WM JESSOP & SONS L⁹ 91 JOHN ST NEW YORK

