

SCIENTIFIC AMERICAN

[Entered at the Post Office of New York, N. Y., as Second Class Matter. Copyright, 1900, by Munn & Co.]

A WEEKLY JOURNAL OF PRACTICAL INFORMATION, ART, SCIENCE, MECHANICS CHEMISTRY AND MANUFACTURES.

Vol. LXXXII.—No. 14.
ESTABLISHED 1845.

NEW YORK, APRIL 7, 1900.

[\$3.00 A YEAR.
WEEKLY.]



Fig. 1.—Northern or Middlesex Entrance.

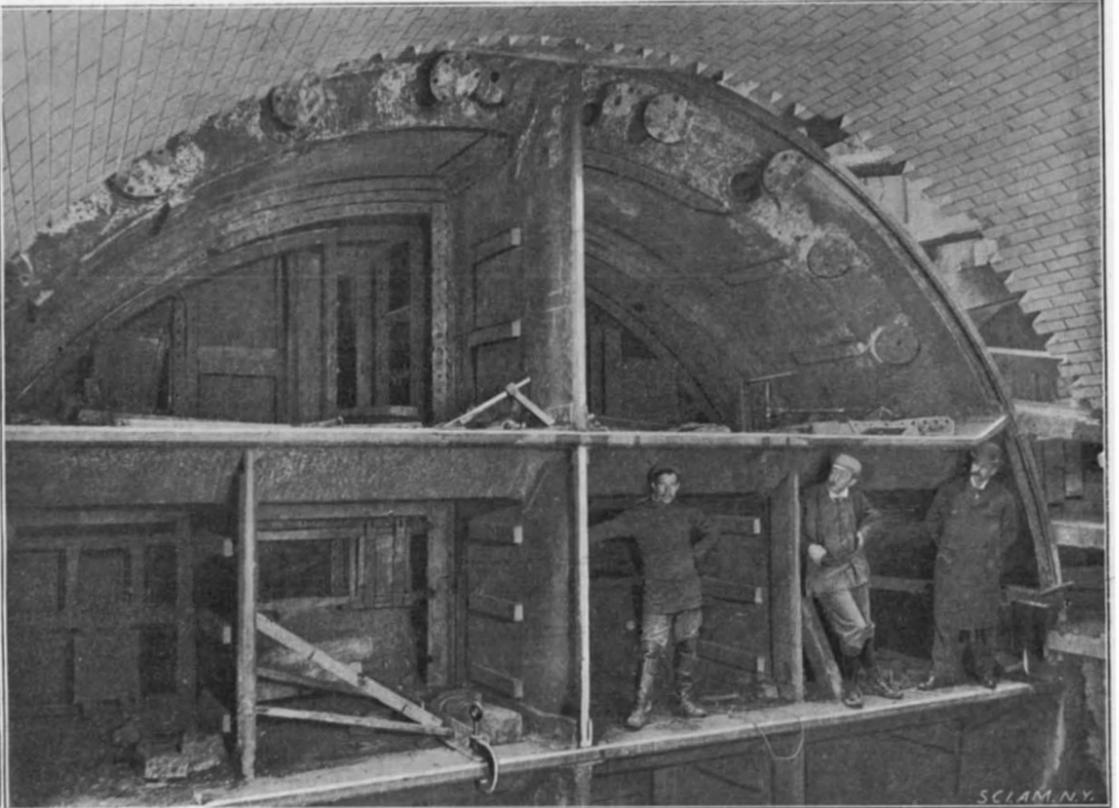

Fig. 2.—The Two Upper Floors of the Shield.

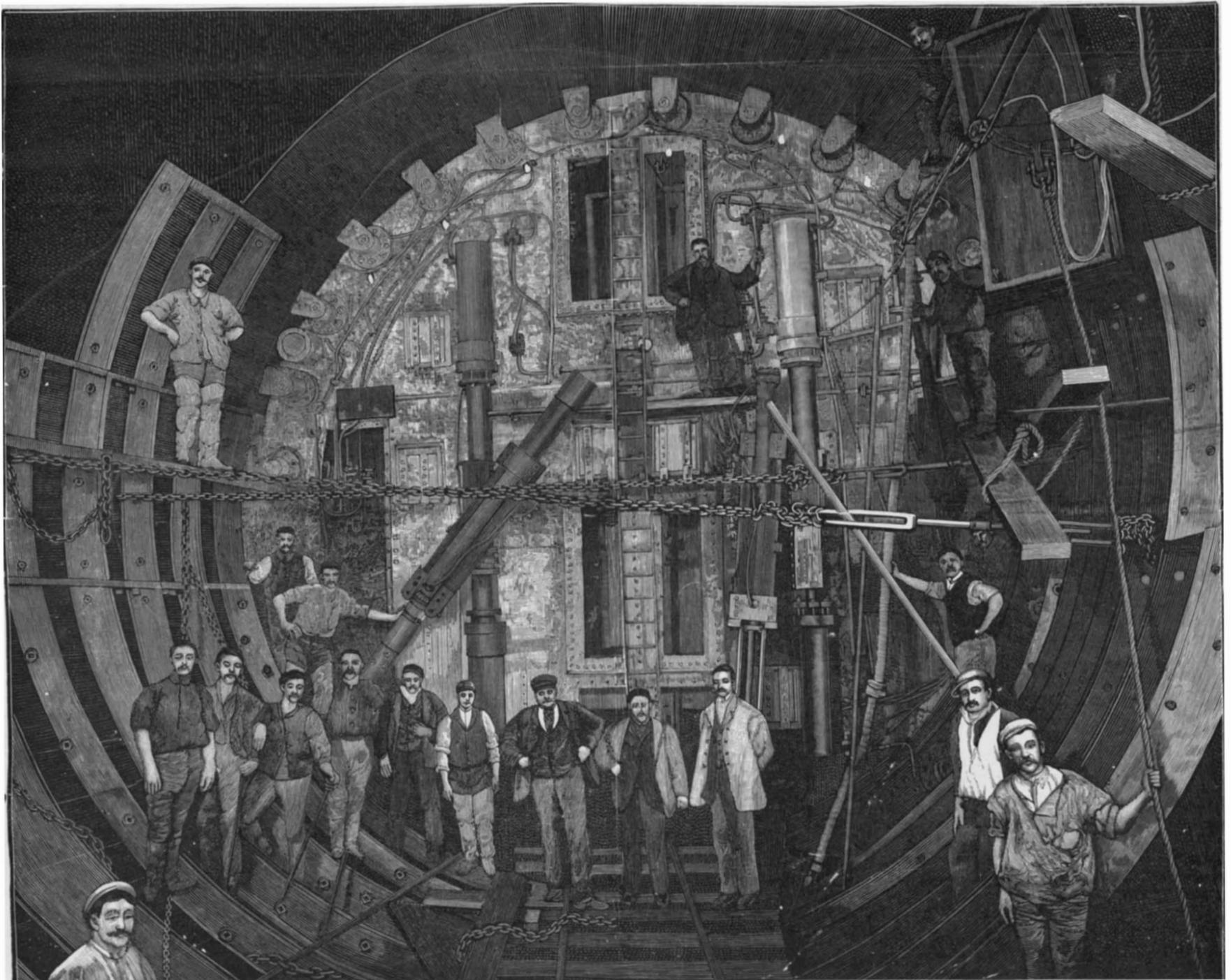

Fig. 3.—View at the Rear of Shield During the Driving of the Tunnel, Showing Cast Iron Lining and the Hydraulic Erectors.

THE BLACKWALL TUNNEL, LONDON.—[See page 217.]

Scientific American.

ESTABLISHED 1845

MUNN & CO., - - - EDITORS AND PROPRIETORS.

PUBLISHED WEEKLY AT

No. 361 BROADWAY, - - NEW YORK.

TERMS TO SUBSCRIBERS

One copy, one year, for the United States, Canada, or Mexico \$3.00
 One copy, one year, to any foreign country, postage prepaid, £0 16s. 5d. 4.00

THE SCIENTIFIC AMERICAN PUBLICATIONS.

Scientific American (Established 1845).....\$3.00 a year.
 Scientific American Supplement (Established 1876)..... 5.00
 Scientific American Building Edition (Established 1885)..... 2.50
 Scientific American Export Edition (Established 1878)..... 3.00

The combined subscription rates and rates to foreign countries will be furnished upon application.

Remit by postal or express money order, or by bank draft or check.
 MUNN & CO., 361 Broadway, corner Franklin Street, New York.

NEW YORK, SATURDAY, APRIL 7, 1900.

OBSTACLES TO THE PROPOSED ERIE CANAL IMPROVEMENT.

The recent course of events at Albany suggests that the proposed scheme for enlarging and improving the Erie Canal will have to travel a rough road before it arrives at the point of actual construction. The indications are that this greatly needed work will have to lie in abeyance for at least another year. That strong opposition should have been developed against the canal was not unexpected. It is well known that there is a number of apparently unrelated interests that would be, or at least think they would be, adversely affected by the enlargement of the existing canal to accommodate boats of a thousand tons or over.

Leaving out of consideration the railroads which, in the nature of things, cannot be expected to look with much favor upon a rival system of transportation whose successful operation would divert an enormous yearly tonnage from their systems, there are other hostile elements, whose opposing influence, tending in one direction, may well prove fatal to the canal. There is first to be considered the farming population of the interior of New York State, who long ago found that wheat growing was unprofitable, mainly because of the cheap rates at which the product could be brought from the great wheat fields of the West, and, who therefore, failed to see how any further cheapening of transportation could better their condition. In many cases they have come to look upon the canal as a toll-road which exists for the benefit of two great terminal toll-gates, New York and Buffalo; and they seem to have lost sight entirely of the fact that of late years the receipts from local traffic on the canal have exceeded those from the through freight.

Another adverse influence, indirect, but undoubtedly powerful, is to be found in the proposal to build a full-sized ship canal from the lakes to the ocean, a scheme that finds its strongest supporters in the wheat producing communities of the West, who see in the creation of a ship canal and the possibility of wheat's being shipped from lake ports direct to its destination in Europe, the prospect of an immediate lowering of freight charges and a consequent increase in the producers' profits.

There are indications of opposition, also, from the vested interests of the transportation companies of the Great Lakes, whose operations under existing conditions are known to be extremely profitable. The opening of waterways, such as the proposed Erie Canal, and the recently opened Canadian Canal, with depths of water of 12 and 14 feet, will, it is feared, disturb the existing condition of things in more ways than one. In the first place, it is certain that it will develop a new type of vessel capable of carrying wheat without intermediate handling direct from Duluth to New York, and again it is feared that the canals will open up the lake carrying trade to the competition of a vast fleet of deep sea steamers of the smaller class. That the existing conditions will be somewhat modified by the canals is not to be disputed, but the fear that they will be prejudicial to the present transportation companies on the lakes is unfounded, for experience has shown that any modifications in methods of transportation which reduce the amount of handling and increase the facilities for the moving of freight invariably benefit the transportation companies themselves as much as they do the general public.

We are of the opinion that most of these objections are based upon a too local view of the economic effects of the canal. The prosperity of the interior of the State is closely related to the prosperity of New York as its great shipping point for the Old World, and the diversion of trade from New York to other ports which has been taking place of late years, unless it be checked, cannot fail very materially to affect the prosperity of interior towns and districts along the route of the canal. As to the shipping interests of the lakes it has yet to be shown in what particular they will be injuriously affected; and as we have said, the increase of traffic resulting from improved facilities must ultimately more than offset any temporary derangement of an ex-

isting and profitable business. As to the deep water ship canal, the report of the government engineers indicates that the interest on the first cost of construction would more than outweigh any possible subsequent benefit to be derived. Furthermore, the conditions of navigation in the comparative calm of the lakes and amid the heavy storms of the Atlantic are so different as to call for an entirely different class of vessel; a ship built for the Atlantic being of a type of construction too strong and unnecessarily costly for the lakes, while the comparatively cheap and lighter-built lake-vessel is unfitted, if not positively unsafe, as the experience of the "Whalebacks" has shown, for deep water navigation.

AUTOMOBILISM IN THE GERMAN POSTAL SERVICE.

The results obtained in the trial of automobiles for the government postal service in Germany do not seem to be as satisfactory as prevailing reports would have led us to expect. At the same time it is to be borne in mind that the conditions imposed for the service were somewhat severe, and that only two types of automobile were given a trial. Furthermore, the failures seem to have occurred chiefly during the snowstorms of the winter, when the efficiency of any type of vehicle, whether horse-drawn or otherwise, is greatly reduced.

The government has decided that the results obtained with the postal cars driven by hydrocarbon motors indicate that the type is not satisfactory for such service, and that considerable improvements will have to be made in the motors before they reach the absolute reliability demanded by the postal authorities. The two electromobiles which were used seemed to have given better results, although they broke down more or less during the snowstorms, the trouble being the same as that which was experienced last winter on the underground trolley roads of this city. The electromobiles had sufficient power but insufficient adhesion. The larger of the two was therefore provided with heavier rubber tires, while the smaller had its iron tires roughened, both changes being made with a view to improve the adhesion. These results do not agree with those obtained in this city, where the electric cabs, under similar conditions, continued to run long after the other means of transportation of the city had been paralyzed.

The Postal authorities also raised the objection that the accumulators are extremely heavy in proportion to the power given out, and they suggest that builders should provide a suitable device to prevent malicious starting of the motors when the driver is not in attendance.

In view of the fact that steam-driven automobiles for heavy work have proved so successful in England and that steam-driven automobiles of a lighter type have given excellent results in this country, it is surprising that the German postal authorities should not have included a steam automobile in these trials. They are light for their power, have excellent hill-climbing ability, and when properly designed and constructed seem to be thoroughly reliable. This adverse report will necessarily be disappointing to the friends of automobilism, but we think that for the reasons given it is not entitled to the weight which a Government report of this kind should naturally carry.

THE WORK OF THE DIVISION OF ENTOMOLOGY.

The work of the Division of Entomology of the Department of Agriculture has been most gratifying during the last fiscal year. As in former years the work of the division may be classified under investigations upon specific injurious insects or groups of insects, experimental work with regard to the determination of specimens sent in, the general investigation of life histories of the injurious insects, work on the geographical distribution of injurious insects of the United States, bibliographic work, investigations in apiculture, preparation of circulars, correspondence, etc., and in addition, this year, work has been carried on upon the exhibit of insects for the Paris Exposition.

The investigations on the insects from abroad is most important. In 1894, a skilled entomologist was sent to Mexico to study the injurious insects liable to be introduced from that country into the United States; this investigation has been carried on continuously until the present time. The results which have been obtained bid fair to become of great importance to certain sections of the United States. The introduction and apparent establishment of the insect which in Mediterranean countries fertilizes the Smyrna fig has heretofore been mentioned. In 1899, an assistant was sent to Porto Rico to collect and study the injurious insects of that island. Large collections were made and a report of the trip will be published in one of the bulletins of the division. The importance of the investigations on foreign insects is shown by an instance which occurred in the spring of 1899, when an insect boring into the stems of orange trees received in California from Japan, was at once recognized by comparison with specimens received some time ago from that country, and the habits of which were reported at that time by a temporary agent of the division. It was at once determined to be a

very dangerous species, and the trees having the insects were destroyed.

Work upon insects damaging forests in the Northwestern States have been carried on and the result of the investigations was that many species new to science were found, and which were undoubtedly engaged in destructive work in the timber of that region. Dr. A. D. Hopkins, the expert, made many observations upon which may be based practical suggestions which will prove of value to lumbermen. Investigations regarding scale insects have been carried on both by the officials of the department and by State officials. Investigations were also started in the autumn of 1899 on insects as carriers of disease, and the results of the investigation will soon be published. Work on garden and greenhouse insects, injurious grasshoppers, and insects affecting the tobacco crop have been carried on during the last fiscal year. Dr. L. O. Howard, the entomologist of the department, gives an outline in his report of the proposed work for the fiscal year of 1900, which includes investigations on the outbreaks of local species of grasshoppers, partial exploration of some of the suspected permanent breeding grounds of the Rocky Mountain locusts, or Western grasshopper, and to carry on the work concerning the establishment of the blastophaga in California to fertilize the figs. Dr. Howard also mentions the need of investigations in the West Indies and the Philippines, and also experimental investigations in apiculture.

CHANGES IN THE ASSISTANT COMMISSIONERSHIP.

By the resignation of Mr. Arthur P. Greeley, Assistant-Commissioner of Patents (who is to engage in private business), the Patent Office has lost one of its strongest men. His breadth of mind and fairness of spirit has done much to advance the interests of the inventors of this country. Born at Methuen, Mass., of old New England stock, he graduated from Dartmouth College in 1883. He was admitted to the bar of the District of Columbia in 1887.

Mr. Greeley's connection with the Patent Office began in 1884, when he was appointed assistant-examiner; in 1891 he became principal examiner, and in 1895 he became examiner-in-chief—strictly upon merit. Commissioner Butterworth requested Mr. Greeley to become Assistant-Commissioner of Patents, which he did on May 27, 1897.

One of the first matters which engaged Mr. Greeley's attention after his entrance upon his new duties as assistant-commissioner, was the restoration of the rules of practice in force prior to 1895, and they were restored on June 18, 1897.

At the time of Mr. Greeley's appointment, the proceedings in the notorious Wedderburn case had already been begun, and the conduct of the matter was very largely in his hands, and his report of his findings and recommendations in the case, which resulted in the Wedderburn disbarment, is generally recognized as of great importance.

During Commissioner Butterworth's long illness, Mr. Greeley had entire charge of the Patent Office, and administered its affairs to the general satisfaction of patent attorneys and their clients.

A matter of considerable importance which came before him during this period was the question of the registration of prints and labels. The registration of prints and labels had practically ceased since 1891, through the construction placed by the office upon a decision of the Supreme Court. Mr. Greeley believing that the construction placed on this decision was erroneous, and recognizing the importance to commercial interests of protection of the prints and labels, reopened the registration in decisions rendered in January, 1898. The fact that in 1898, 235, and in 1899, 611 prints and labels, many of them lithographs of unquestionable artistic merit, were registered, indicates the importance to the business interests of the country of Mr. Greeley's policy in this matter.

Mr. Greeley has, both in his work as Assistant Commissioner and in his work as a member of the commission to revise the patent and trademark laws, to which he was appointed by the President in 1898, taken great interest in trademarks and their protection in this country and abroad. In 1899, he published a volume on foreign patent and trademark laws, in which for the first time the systems of protection of trademarks in foreign countries are presented to the American public in comparison with the trademark law of this country.

Perhaps the most important cases which come before the Commissioner or Assistant Commissioner for decision are the interference cases. Mr. Greeley's decisions in these cases have seldom been appealed from, and in but one case out of eleven which have been decided by the Court of Appeals on appeal from his decision, has his decision been reversed.

We wish Mr. Greeley success in his new undertakings.

The new Assistant Commissioner of Patents is Mr. Walter H. Chamberlain, of Chicago, who was promptly nominated by President McKinley. The selection is an admirable one, as since his admission to the bar in 1890 he has made a specialty of patent law. He was

born in Detroit in 1866, and entered the office of Wells W. Leggett, a son of the former Commissioner of Patents. He soon became a well-known patent lawyer.

We understand that Mr. Chamberlain was appointed through the recommendation to the President of the Commissioner of Patents.

SOME CHINESE VEGETABLES.

A thorough investigation of the food and vegetables offered for sale in Chinatown, San Francisco, is being made by Prof. Walter Blasdale of the chemistry department of the University of California, and undoubtedly many of the vegetables can also be obtained in the Chinese quarters at New York. They form a remarkable collection, entirely different from that of Caucasians. In fact, the Chinese do not care at all for our vegetables with the exception, perhaps, of celery. Many of their common vegetables would form an agreeable addition to our own tables as they possess qualities of flavor and nutrition which, in many cases, are equal to any of the vegetables so common with us. "Po kua" which is used for cooking, is grown both for its fibrous pulp and as a food. It is a long gourd-like vegetable measuring when mature about 24 inches and is yellowish green in color and contains quantities of sugar and starch and is highly nutritious, but is inferior in flavor to the delicate qualities which make the squash a desirable vegetable. The young green and hairy fruit of the "zit kwa" is a kind of melon growing on a vine and is boiled and seasoned like a squash. The interior is made up of a white, solid flesh, set with rows of white seeds. When mature, says The San Francisco Chronicle from which we derive our information, these vegetables weigh thirty pounds, and are covered with an exudate which hardens to a white wax. The hairs disappear, and the surface is perfectly smooth. This product is used by the Chinese for making a confection, and in this form has a taste and flavor as agreeable as many of the glazed fruits. The "chu ko" is something like an ordinary potato in starchy content and nutritive value, but in appearance resembles the beet. It is the most common and valuable of cultivated root crops among the Chinese, as it holds among them about the same place as does the potato with us. Analysis shows it to be a dietary article far superior to the potato. It has a flavor characteristically Chinese and would probably not be esteemed by us. The root yields excellent starch, and is largely employed by the Chinese in making that commodity. It is grown on swampy land. The "taro" somewhat resembles the last named vegetable. It is also grown in the Hawaiian Islands. It resembles an ordinary red beet whose consistency is that of a sweet potato. It has found favor with many American families, and their purchase of the bulb comprises no inconsiderable part of its sale. It can also be used as an ornamental aquatic plant, the roots being easily started. An extraordinary thing, which has been noticed, is that nearly all of the vegetables of Chinese origin have a considerable proportion of manganese. Prof. Blasdale has found that the green color characteristic of manganese was always present in a greater or less degree upon igniting the ash of the Chinese vegetables. The water chestnut or "ma hai" shows the largest quantity. This is a well-known food in Chinese quarters. It has a sweet chestnut flavor and is juicy and watery in consistency. It has a thick, tough brown outer skin. Within it is white, and when grated yields quantities of starch. It is eaten either raw or boiled. It does not resemble the chestnut in any sense, being a little bulb, and growing at the bottom of a collection of long, marsh grass stems. A considerable proportion of Chinese vegetables are produced from swamps.

The lily bulb called by the Chinese "pak hop" finds a large sale, the price ranging from 10 to 20 cents. They are sold green and dry and are regarded as a delicacy. The seeds of the lotus which grow largely in China are roasted and ground. They are then made into bread and are used largely in soup. They are eaten raw, boiled or roasted and are sold in great quantities in Chinatown, two varieties of them being obtainable. The Chinese also eat varieties of sweet potatoes which are almost like those grown in this country. The "fan ko" or yam bean grow upon a fibrous vine which runs along beneath the surface of the ground. They are covered with a thick yellow stringy bark which peels off and leaves a white fleshy interior, firm and sweet to the taste. Above the ground the vine bears rounded leaves and white flowers, bulbs or beans containing large quantities of starch and cane sugar, and have a sweet insipid flavor, but are nutritious. The most poisonous vegetable which the Chinese eat is "ginseng" which contains hydrocyanic acid. It is rich in starch and nearly all the proteins is true albuminoid, and it contains large quantities of both cane and reducing sugar. The roots are about 20 inches long, 4 inches thick, and weight about 1½ pounds. They taper at both ends and are curved with gray bark. The flesh is white and sweet and is traversed by bundles. It is very starchy and is used largely by the Chinese as a source of starch which they make into a kind of tapioca.

Beans are the great standby of the Chinese and the "soy bean" is the most important. There are a vast variety of other beans and they are boiled, baked, made into soup, and are even made into a bean cheese. In preparing this cheese the beans are soaked in water for thirty-six hours. They are then reduced to a paste and the mass cooked. This is strained through a coarse cloth, thereby making a white fluid much resembling milk and having some of its characteristics. A crude salt is added which coagulates and precipitates the protein material in this fluid, and the mass resulting is kneaded into small square cakes so common on the Chinese grocers. Sauce is also made of the beans, and a kind of macaroni, looking very much like old-time yellow taffy. Most of the beans are sprouted or germinated and are eaten as green vegetables and in nearly all Chinese groceries may be seen bucketsful of sprouted beans, the young plants curling around the kernel. They have been soaked in water until the hulls were softened and the growth started. Watermelon seeds are also commonly eaten, and for the variety chiefly used they are boiled for thirty-six hours before they are fit to eat. Purslane is extensively used as a pot herb and ginger, both the roots and stalks are eaten in great quantities as are also several varieties of bamboo shoots. Many of the products are imported from China, but most of them are now grown along the banks of the Sacramento and are brought every morning to the groceries in the Chinese quarters of San Francisco.

THE PATENT OFFICE EXHIBIT AT THE PARIS EXPOSITION.

The Patent Office holds such a unique place in the life and activities of America, that it is only fitting that in the closing exposition of the century we should be represented by an adequate exhibit of what the patent office really means, and the important part that it has played in aiding us to surmount the ladder of industrial supremacy. The patent office exhibit will be in the charge of Principal Examiner Edward Bruce Moore, Esq., who sailed on March 29. The exhibition, which will not be large, will be of unusual interest, embracing some 208 models, which will reflect the inventive genius of America. Heretofore it has been the custom at expositions to show the time-honored models of the early inventors; this year, however, a new plan has been adopted which bids fair to be an immense success. This is to confine the exhibit of this year to models representing the basic principles of electricity, as applied to the arts, and to commerce. A special act of Congress was necessary to allow the models to be removed from the country. Delay in legislation resulted in the necessary curtailment of some of the exhibits. The early models of Edison, Brush, Thompson-Houston, Maxim, etc., will be most interesting. The first electric motor of Joseph Henry will also be a most important exhibit, dating as it does from 1834. The electrical propelling machinery of Davenport (1837) is also noteworthy. The first printing telegraph invented by Edison in 1873 will be displayed. The early telephone and phonograph models will also probably be much sought after. The selection of Mr. Moore is an admirable one, and is a compliment to and recognition of his ability.

M. TRILLOT ON COLOR PHOTOGRAPHY.

M. Trillot has recently presented to the French Académie des Sciences an account of some experiments which he has made in the direction of color photography. Starting from the well-known fact that in a photographic plate the image is formed of a precipitate of silver in the amorphous state, whose granules are dispersed throughout the thickness of the supporting film, the experimenter wished to find out whether this amorphous silver could be transformed into a series of superposed films or laminae, and in this case color effects would probably be produced by interference. To solve the problem it was necessary to find a process for dissolving the precipitated silver contained in the film, and then to find a reagent which would precipitate it again in the laminated form. It was found impossible to treat the image in a liquid bath, as the solvent in this case attacks the image and carries away a part of the silver. The desired result is obtained by exposing the image to certain vapors which act upon the silver without altering the gelatine. Nitric acid vapor was found to be the best suited for the purpose, and the plate, after going through a process of cleaning, polishing and hardening, is placed in a vessel containing commercial nitric acid. After a few seconds' exposure to the vapor, the image is seen to diminish, and it finally disappears entirely, the plate becoming transparent and the precipitated silver being dissolved to a seemingly colloidal state in the interior of the film. In order to make the image reappear in the laminated state, it is exposed to hydrogen sulphide containing water vapor, upon which the image is seen to reappear, presenting a metallic appearance. By continuing the treatment the outline of the object is distinguished, and finally a strong coloration, having a metallic luster, appears on various parts of the image. If the treatment is prolonged, these colors fade out and be-

come diffused. The process being stopped at the proper moment, the plate is dried, and upon examination of the glass or gelatine side by reflected light, a polychrome image of strong color is perceived. The colors on the two faces of the plate are often complementary, seeming to show a dissymmetrical arrangement the reflecting structure. These colors are quite stable, but change momentarily when exposed to moisture.

Generally speaking, there is no definite relation between the natural colors of the object and those produced upon the plate by this process, but on the other hand, it is possible to cause a localization of certain colors desired, especially where the different parts of the image present considerable variations in thickness, and these colors may be made to approach more or less to the natural colors of the object.

To show what may be done by the process, M. Trillot presented several positive plates of the same subject, in which the colors green, red, and white are localized upon the corresponding parts of the image, which in this case represent foliage, red tiled roof and white walls. It will be seen that it is of importance to use orthochromatic plates in applying this process. M. Trillot is making further experiments, and expects to be still more successful in producing a polychrome image.

OUR EXPORTS OF IRON AND STEEL.

No feature of the marvelous growth of our commerce is more striking than that relating to exports of iron and steel. The total foreign commerce of the United States in the year just ended has for the first time crossed the \$2,000,000,000 line, and the total exports of the manufacturers of iron and steel have for the first time crossed the \$100,000,000 line. In the calendar year, 1890, the total exports of iron and steel amounted to only \$27,000,000, but in 1899 they were \$105,689,645. In the same period the importations of manufactures of iron and steel have decreased with nearly equal rapidity, the importations of 1890 being \$44,544,140, while those of 1899 were \$15,799,206. The striking feature of this rapid growth in our importation of manufactures of iron and steel is the fact that European countries are taking largely from us in these lines.

In builders' hardware, for instance, the United Kingdom took nearly \$2,000,000 worth in the year just ended, and Germany more than \$1,000,000 worth; and the exports to the United Kingdom of sewing machines were \$1,285,609 in 1899, against \$806,401 in the preceding year, and the trade in the same line with other countries was also gratifying. For new and ingenious machinery the world seems now to be looking to the United States. Exports of electrical machinery increased from \$917,453, in 1897, to \$2,523,644 in 1898, and \$3,143,336 in 1899, and metal working machinery from about \$4,000,000 in 1897 to nearly \$7,000,000 in 1899. Railway engines increased from \$3,000,000 in 1897 to nearly \$5,000,000 in 1899; typewriting machines from \$1,566,916 in 1897 to \$2,776,363 in 1899. Such lines of machinery as cash registers, laundry machinery, printing presses, shoe manufacturing machinery, fire and stationary engines show a marked growth.

In 1880, the production of pig iron in tons in the United States was 3,835,191 tons. The value of iron and steel manufactures exports was \$15,422,874, while the imports amounted to \$63,956,853 in manufactures of the same line. Nineteen years later, in the calendar year 1899, the pig iron production amounted to 13,620,703 tons, while the exports of iron and steel manufacture amounted to \$105,689,645, while the imports in the same line shrunk to \$15,799,206.

DEATH OF PROF. PEPPER.

Prof. John Henry Pepper, an author and analytical chemist of some distinction and inventor of the so-called Pepper's Ghost, is dead. He was born in 1821, and became famous through the illusion known as "Pepper's Ghost," which was perfected by him from a rough model devised by Henry Dirck. By it the reflection of the figures of the actors behind the scenes were thrown upon the stage by a system of mirrors. These reflected images had all the semblance, and repeated all the actions of the living originals, but were, of course veritable apparitions. The illusion was a great success when first produced and realized \$60,000 in six months. The ghosts were exhibited for a long time in the London Polytechnic and curious effects were wrought with them in various ghostly dramas. An attempt was made to utilize the system for the ghostly manifestations in "Hamlet," "Macbeth," and "The Corsican Brothers," but the plan did not seem to succeed very well on account of the fact that the specters though plainly to be seen by the audience were invisible, for optical reasons, to the actors upon the stage so that it was almost impossible to secure perfect harmony of action between the shadow and the substance.

It is proposed to build a suspended bridge at Duluth, over the ship canal, similar to that over the Seine at Rouen. The city power house is to supply the current,

A PERFECTED BURNER FOR INCANDESCENT MANTLES.

Coal gas still continues in the contest with its new competitors, and it is enabled to maintain its position by the use of new burners which furnish more light for a smaller consumption. For some time now the authorities have had in use in Paris, a new burner with incandescent mantles, which increases the power of the light. The principle of the Auer mantle is well known, and everyone knows that the more the temperature of the flame in which it is suspended is increased, the brighter the light becomes. With the ordinary Bunsen burner, nothing like the maximum temperature is attained, and the mixture of air and gas takes

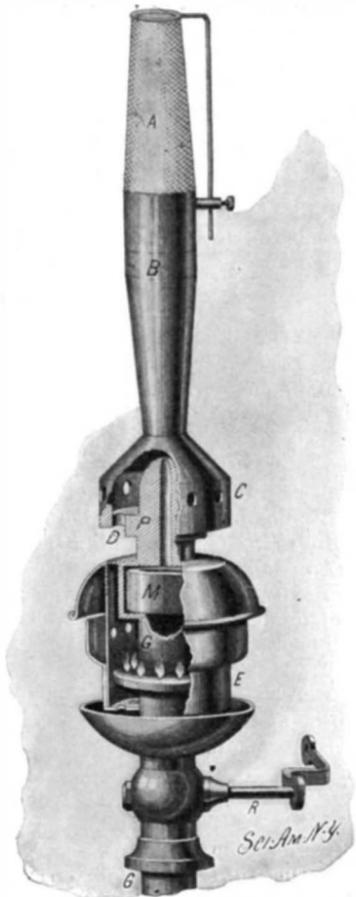

THE SAINT PAUL, A PERFECTED BURNER FOR INCANDESCENT MANTLES.

place under poor conditions; it is not intimate enough, and does not yield a homogeneous product.

In the new burner, the gas is heated before it enters the mixing chamber, where it comes in contact with the air. Reference to the figure will show how this is accomplished.

A ring, *H*, is placed around the burner pipe and connected with it by a small tube. The ring is in a chamber, *E*, having a circle of small holes in its side, and serving as a warming chamber for heating a metallic ring, *M*, enclosed in the tube, *G*, through which the gas passes to the ejector, *P*. *H* has a series of small holes through which the gas escapes, and, being lighted, furnishes heat. When the gas reaches the part of the burner where it mixes with the air, which enters through the holes, *C* and *D*, it has reached a temperature which, experiments show, favors the homogeneity of the mixture. It then escapes through the conical tube, *B*, at the end of which it is lighted and makes the mantle incandescent.

From experiments which have been made with this burner, it is found that the flame has a temperature of nearly 1800° C., which causes the incandescent mantle to give a much brighter light than it does with the ordinary type of burner. In a short time now anybody will be at liberty to manufacture these burners and their price will decrease, so that incandescent lighting by gas is in a fair way of being more generally used.

The Peary Meteorite.

The great meteorite which Lieut. Peary brought back from his last expedition still remains on the Cob Dock of the Brooklyn Navy Yard. It is the largest in the world, and Lieut. Peary has been trying to dispose of it to some museum. Rear-Admiral Philip, commandant of the yard, desired to place the meteorite on exhibition near the guns taken from the Spanish during the late war, and he applied to the Secretary of the Navy for permission to do so. The Secretary

informed him, however, that the department had no jurisdiction over the meteorite, it being Lieut. Peary's personal property, the Navy Department giving him permission only to land it and leave it on the Cob Dock until he could dispose of it. We illustrated the raising of this most interesting meteorite from the hold of the "Hope." The meteorite weighs 200,000 pounds, and it is said that Lieut. Peary wishes to obtain \$75,000 for it.

A Hypothetical War.

Our esteemed French contemporary, *Le Monde Illustré*, has recently devoted an entire number to the description and illustration of a hypothetical war between England, France and Russia. The conflict is supposed to take place in the present year, and the results are most disastrous. We feel that a publication of this kind, even though it is a pure figment of the brain, does positive harm by giving people a false idea of war, its horrors, the ease with which victories are gained—on paper. It is assumed that the conflict arises from an attack by Afghan bands upon a Russian city, at the instigation of England and naturally France was brought into the contest. The first illustration shows the junction of the Russian and French fleet at Bizerta, this is followed by an illustration of the bombardment of Marseilles by the English squadron; then comes the Franco-Russian fleet passing the "impotent Gibraltar," followed by a number of views showing naval and military operations, and realism is given to the pages by the insertion of a number of pictures of those who would actually participate in this suppositious and unfortunate war. The most objectionable of all the pictures, perhaps, because of the evil suggestion it conveys, is the assassination of Lord Cromer at Cairo. The taking of Malta, is also depicted; battles in India and the great naval combat of the combined fleets in the English Channel, and finally the landing of the troops at Brighton, and, as might be expected, the French troops enter London and peace is declared. The entire article is couched in Chauvinistic terms and is concluded by a map showing the repartition of the world in which Ireland becomes an independent republic, Gibraltar falls to Spain, Malta to Italy, Cyprus to Greece, India becomes independent, and the Philippines are given to Japan, although at the time of writing we believe they belong to the United States. Africa and Asia are repartitioned and the United States seems to have received nothing but Canada, while Jamaica is given to Cuba, and Australia becomes a new confederation. The subject would be amusing were it not for the sinister purpose which existed in the minds of those who conceived and carried out the suggestion and the inflammatory effect such publication may have upon the imaginations of an excitable people.

A ROPE ARMORED ENGINE.

On other occasions we have referred to the armored train which has played so important a part in the South African war. Almost the first incident of the war was the attack on the armored train near Mafeking and a similar incident was the memorable fight at Chieveley in which Winston Churchill was engaged. Col. Baden-Powell and Col. Kekewich, at Mafeking and Kimberley, respectively, have armored trains, which have been in almost constant use. As is well known railway iron and boiler plates are the usual protection, but the locomotive shown in our engraving was made safe in an unique manner. Rope mantlets were used during the Crimean war and the protection of the locomotive by rope may be regarded as a new adaptation of the mantlet. The first thought which is brought to mind after looking at a picture of this engine, is that the work was done by sailors, and this is correct for sailors devised the protection for the Colenso

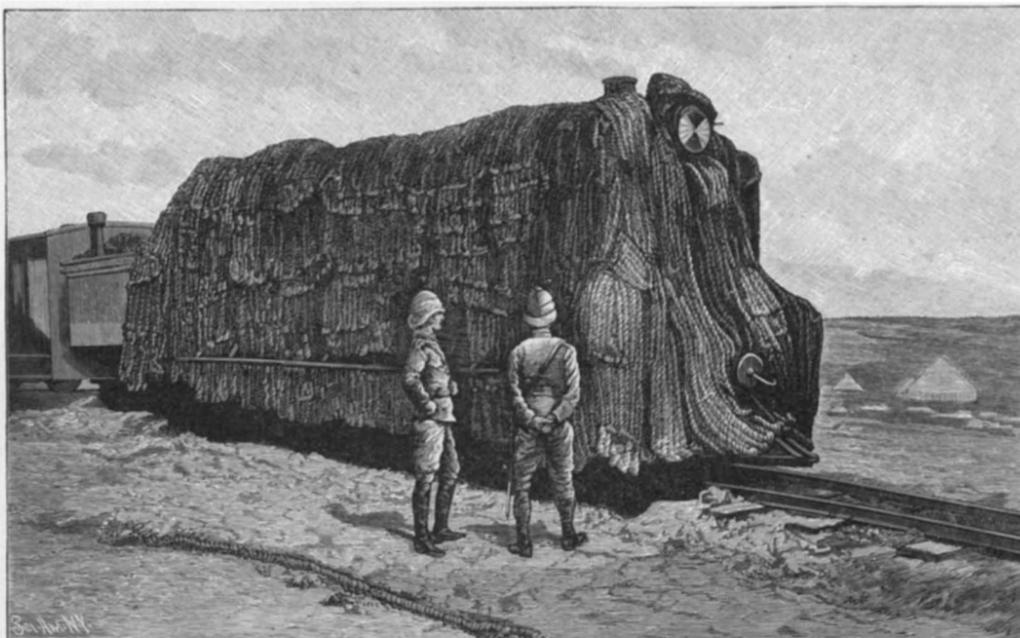

A ROPE ARMORED ENGINE ON THE COLENZO LINE IN NATAL.

armored engine. Its appearance is most grotesque, looking not unlike a gigantic French poodle dog. It has been found that the rope protection is a most admirable one, although no very full details have been forwarded of the construction. It is probable that the engine is run entirely by bell signals, the engineer and fireman being entirely protected.

A NON-REFILLABLE BOTTLE.

A new form of bottle has been patented by Joseph Goodman, of New Haven, Conn., which is inexpensive, and which is designed to prevent refilling after the contents have been poured out. The illustrations are sectional side elevations, showing the bottle upright and tilted.

The bottle is formed with a short neck, upon which an extension is secured, provided with an apertured partition which divides the extension into an upper and lower compartment.

The upper compartment receives the stopper or cork; the lower compartment a valve-cage, the bottom of which is formed with a flange, locking with a flange

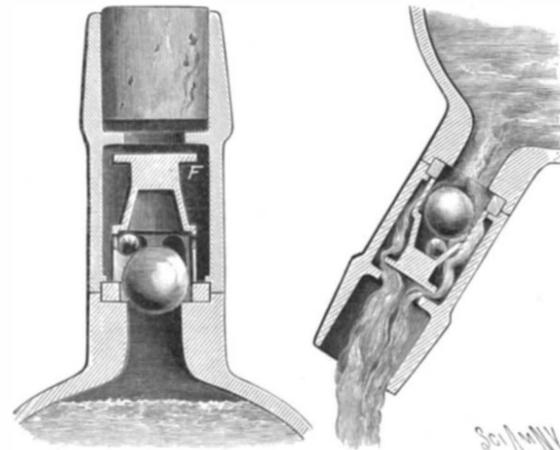

NON-REFILLABLE BOTTLE.

on the extension. The cage consists of a hollow, apertured cylinder above the flange. The cylinder is surmounted by a hollow cone closed by a baffle-plate, *F*, and formed with a base having an annular shoulder at its junction with the cylinder.

A ball-valve moves within the hollow cylinder, closes the neck when the bottle is in an upright position, and fits on the annular shoulder of the cone when the bottle is tilted. A locking-ball in the cage bearing on the annular shoulder holds the valve to its seat when the bottle is in vertical position, and rolls into the hollow cone when the bottle is inverted.

The arrangement of the apertured partition and the baffle-plate, *F*, prevents the introduction of a wire to unseat the ball-valve in attempting to refill the bottle; for the baffle-plate will deflect the wire sidewise. The ball-valve is to be made sufficiently light to float in liquid. If glass be the material used, the interior will be hollowed, so that the bottle cannot be filled under a vacuum. When the bottle is held in a horizontal position the locking-ball will roll down the sides of the hollow cone to seat the ball-valve.

Acetylene for Autocars.

(Archiv. Post Tele. 11. pp. 555-568, 12, pp. 602-612, June, 1899.)—The author predicts, says Science Abstracts, when safe methods of generating and storing acetylene have been discovered it will displace petrol as the explosive agent in motor-car engines. Acetylene explodes best when mixed with 12 parts of air, whereas the best proportion for coal gas is 6 parts of

air. The fuel for 10 horse power for 100 hours, which in a Serpollet generator occupies 4 cubic meters, and in a petrol motor 316 cubic decimeters, only requires 300 cubic decimeters in an acetylene engine. Moreover, acetylene is more cleanly and smells less. Ravel has experimentally found that the efficiency of acetylene is two and a half times as great as that of ordinary coal gas, but he concludes that a type of gas engine suitable for it has yet to be found. Claude and Hesse have shown that, under a pressure of 12 kilogrammes per square centimeter, 1 liter of acetylene will absorb no less than 300 liters of acetylene, all of which will give off again upon lowering the pressure.

THE Paris Exposition will be commemorated by an issue of French stamps which will be sold beginning on the opening day.

A PROBLEM IN SHIP PROPULSION.

It would seem as though our friends across the border were determined to find some method of ship propulsion radically different from that by which the rest of the world seems content to drive its vessels. It is not so many months ago that the Knapp roller boat was very much in the public eye by virtue of the attempts of its inventor, alike ambitious and novel, to replace



DUMP AT THETFORD, CANADA.

THE ASBESTOS MINES AT THETFORD, CANADA.

BY L. P. GRATACAP.

The asbestos products of the world are principally furnished from mines in Canada, and of prime importance among these are the large and important quarries at Thetford, Province of Quebec, Canada. Here are three large companies whose properties embrace many acres in the Cambrian areas of the region, be-

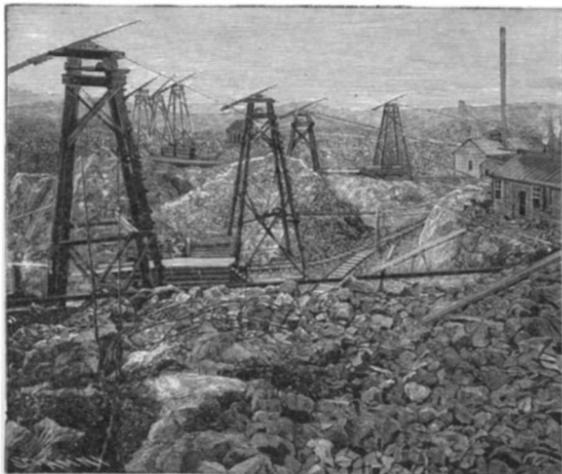

DERRICKS AT THE ASBESTOS MINE.

they descend into the pits, run the swaying carriages bringing up their cradles of stone which are dumped into waiting cars, and carried to the separators, crushers and dump. The scene on the floor of the pit is full of action, and gangs of workmen at various points are blasting, hammering, or prying open the ledges, and exposing new surfaces of the serpentine.

The production of asbestos from this source, viz.,



ASBESTOS MINES AT THETFORD, CANADA.

the ordinary type of ship with a huge cylindrical vessel, whose progress should be in direction at right angles to its longitudinal axis, and which should be trundled over the waves in much the same way as a barrel is rolled through the streets. Hitherto the rolling has been confined to more or less sheltered waters, although the inventor promises that before long freight and passengers will be rolled from New York to Queenstown and Liverpool.

We now present a couple of illustrations of another Canadian idea of ship propulsion, in which the hull, or a considerable part of it, instead of rolling, revolves. It is being built at Toronto for a syndicate of gentlemen in that city, who presumably expect to find advantages in their new device which cannot be realized in any existing type of boat, or otherwise. The vessel consists of a cigar-shaped, steel hull, which is encircled for about a third of its length by an outer revolving cylinder. The cigar-shaped portion of the vessel contains the motive power and the crew, and the outer cylinder, which serves as a propeller, is provided with projecting metal plates which are wound helically around it in the form shown in the illustration. The outer cylinder revolves upon the inner cylinder, friction being reduced by interposing carefully constructed roller bearings. It is driven through a gear wheel, 12 inches in diameter, which works in a water-tight case and engages a circular rack formed upon the inner face of the outer cylinder. The vessel is driven by a four-horse power gasoline engine. In order to prevent any rotary movement of the inner cylinder, it is provided with a keel which is about 12 inches in depth and is hung below the vessel in the manner as shown. The keel is also intended to prevent the vessel from making leeway. The shallow depth of the keel, and the fact that it weighs only about 125 pounds, will render it difficult to keep the boat on an even keel, and it has been suggested that a deeper keel, carrying a cigar-shaped weight, something after the fashion of the bulb-keel racing yacht, would give better results. In addition to the accommodation within the hull there is a deck at each end of the boat which is protected from the wash of the water by flaring coamings, connection from one deck to another being had by means of a bridge which extends above the revolving cylinder. The boat has recently been completed at the shops of Walter Dean, boat builder, Toronto, and its trials are due to take place early in April.

Duty on Natural Gas Refunded.

The Treasury Department has refunded \$21,814.50 which had been collected at Detroit from one concern as duty on natural gas brought into Detroit from the Canadian gas fields. The duty was levied at 10 per cent ad valorem as an "unenumerated raw or manufactured article." The refund was based on a decision of the United States Supreme Court on another case in which the court held that natural gas could only be classified as crude bitumen. The only tariff fixed on this article being \$1.50 a ton, it was impossible to levy an tax on the gas.

American Locomotives in Germany.

The Prussian Minister of Railways has expressed a favorable opinion of the American locomotives that have been tried in Bavaria. He says: "Notwithstanding their faultless construction, they cost considerably less than locomotives of similar style of Prussian make."

tween the valleys of the St. Francis and Chaudière Rivers. The mining grounds both at Thetford, and Black Lake twelve miles south, are situated in a group or range of low hills penetrated by the Quebec Central Railroad by whose instrumentality they have been brought into commercial usefulness.

The matrix rock of asbestos is here serpentine, and the asbestos is a silky, fibrous form of this mineral, usually designated by mineralogists as chrysotile. It occurs in veins; seldom in their maximum development over three inches wide, occasionally six, and far more

chrysotile, has greatly increased since its first discovery, and has now attained the dimensions of a valuable industry. In 1890, the output was surprisingly great, and has exceeded all previous or subsequent years. The accompanying diagram illustrates very graphically the fluctuations and course of asbestos mining in Canada. It is taken from the Geological Survey of Canada for 1896. The solid line shows the production in tons, the broken dash line the varying value of the product, the dotted line average value per ton, the dot and dash line the exports, average value per ton.

The money value of this material is not inconsiderable. For the years from 1880 to 1896 the following table shows the total values for Canada.

Year	Tons	Value
1880.....	380	\$24,700
1881.....	540	35,100
1882.....	810	52,650
1883.....	955	68,750
1884.....	1,141	75,097
1885.....	2,440	142,441
1886.....	3,458	206,251
1887.....	4,619	226,976
1888.....	4,404	235,007
1889.....	6,113	426,554
1890.....	9,860	1,260,240
1891.....	9,279	999,878
1892.....	6,082	390,462
1893.....	6,331	310,156
1894.....	7,630	420,825
1895.....	8,756	368,175
1896.....	12,250	429,886

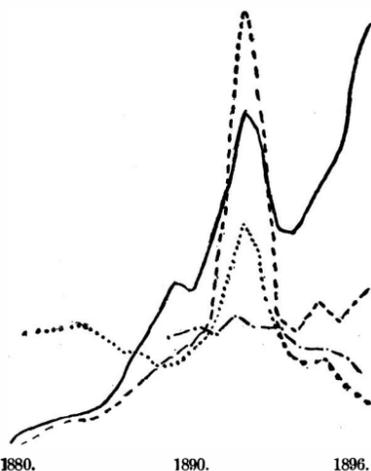

PRODUCTION OF CANADIAN ASBESTOS.

commonly one inch. It is recognized instantly by the sheen and luster of its surface. These veins traverse the dark serpentine rocks in varying directions, and the excavations made in this hilly country to reach these valuable skeins of mineral thread are very extensive.

A view into the dark cavernous pits, now formed into one colossal opening in the Bell Company's workings, through the removal of their separating walls, is extremely picturesque. The pits vary from 100 to 150 feet in depth, and the cliffs frowning above them are sprinkled with derricks along whose steel cables, as

There are three grades of asbestos, and of these the second is the most abundantly produced. Much of the floor of the Thetford mines, which is now being deepened, yields a poorer quality than the cliffs or sides. The best grades have been found below the surface. The surface specimens are harsh and asperated. This is the result of losing water; in the case of the Thetford mines, from forest fires, and in the Black Lake district from baking in the vicinity of the many igneous dikes which have entered the serpentine, and presumably calcined the chrysotile. As is well known, the water carried in the asbestos imparts the delicate texture, and when this is driven off by heat, the fibers become hard, brittle, and coarse.

The veins are sharply separable from the inclosing serpentine, and a blow of a hammer will detach the adhering rock on either side, liberating the lustrous bar of delicate mineral silk, which, soft and silken in its separate fibers, resists compression in the direction of their lengths. These bars are hackled and converted into wooly-like knots which are afterward carded and spun into asbestos thread. The treatment of the second and third grade asbestos varies somewhat from that of the first quality, and the final discharge of the jig-sieved fragments meets the discerning inspection of small boys who pick out useful material, which is again worked over. Much of the water-saturated material is dried in ovens.

The serpentine area is a disjointed or irregular succession of these ranges, or hill groups in which serpentine is found, extending from Oxford to Gaspé. The Thetford and Black Pond districts have proved the most productive, though prospecting continues in other sections, and recently some investigation in the Ottawa district has raised the hope of opening profitable mining in this new field. The development of these veins of fibrous serpentine is obscure. They have

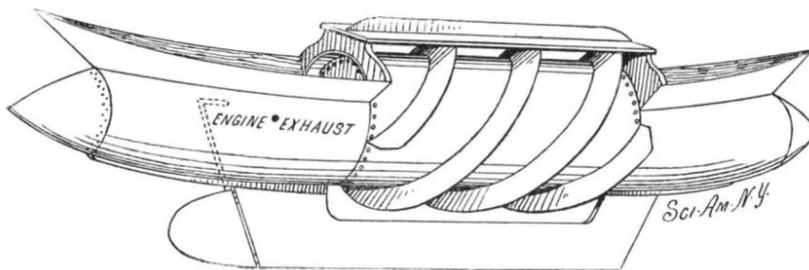

REVOLVING BOAT AS COMPLETED, SHOWING THE KEEL AND CONNECTING BRIDGE.

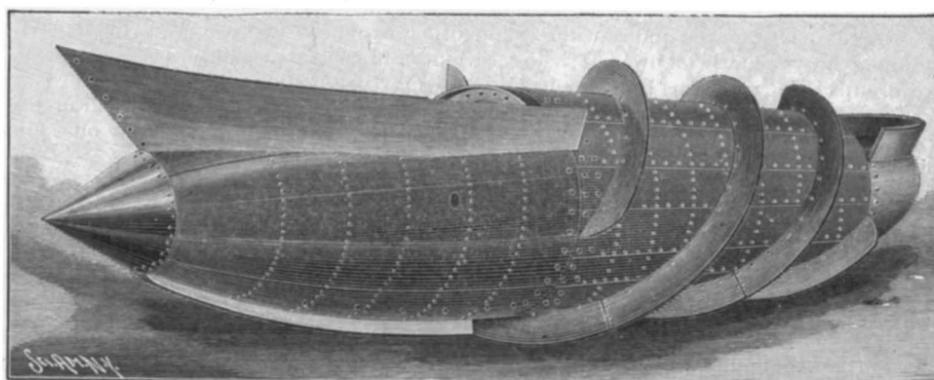

TORONTO REVOLVING BOAT DURING CONSTRUCTION.

been regarded as veins of segregation, a most unlikely, almost inconceivable origin, and Prof. G. P. Merrill has suggested that they represent a sort of "pulling out" action, whereby the serpentine has been drawn out into these mineral threads. The serpentine is clearly an alteration product, and is doubtless formed from the change of diorite, an intrusive rock composed of trichlorite feldspar and hornblende, with possibly a large admixture of chrysolite (olivine). This rock has been invaded by later dikes of white granulite or granite, much of which I saw at Thetford, where the association of the chrysotile or asbestos with this later intrusive has been commonly observed. That there is any causal connection seems doubtful. The asbestos may, I think, be regarded as the alteration of previous seams of fibrous hornblende, retaining the position of the antecedent mineral; and these fibrous hornblende separations have themselves been formed by movements in the original pasty or semi-consolidated (crystallized) diorite.

Great dumps resembling small hills are pushed outward into the lowland to the west of the village of Thetford, and when, as in some cases, the available area is disappearing for mining, the dumps, which still retain a great quantity of asbestos of the smaller and poorer grades, may be worked over, and will furnish employment for years.

The price of asbestos has declined, partly owing to improved methods of preparation, increased production, and competition. A further use for some of the less marketable grades of asbestos has been discovered in its adaptability to form a "holder" in cement, in place of hair. This use now consumes a large quantity.

The mines are worked by French workmen, and this desolate and lonely spot of rugged hills, distinguished by the one long, straggling street of humble white houses, the white spire of the church, the broken hill country around the excavations, and its vivacious population forms a curious picture, and leaves on the visitor a series of strange and interesting impressions.

THE EXPIRATION OF THE EDISON AMERICAN THREE-WIRE PATENT.

On the 20th of March the patent No. 274,290 issued on March 20, 1883, to T. A. Edison, expired by limitation. This is the fundamental American patent corresponding to the famous Hopkinson patent in England for three, five, or multi-wire systems, with any number of conductors, and which was regarded as a patent of the greatest possible value. It was a strongly drawn patent, showing that the inventor had an inkling of the conditions which would exist during the life of the patent, the drawings showing several modified arrangements for balancing which have since been either used or proposed, such as the use of the storage battery and the third brush on a commutator delivering from its positive and negative ends the full voltage between the outer conductors. The patent claims strongly the compensating conductor or conductors in the following words: "What I claim is a system of electrical distribution having translating devices arranged in multiple series, the compensating conductor or conductors connecting the translation-circuits with the source of energy substantially as and for the purpose set forth." Owing to the general interest of this patent, we give a short description of the three-wire system taken from "Experimental Science."

In the three-wire system a saving of 25 per cent in copper is made. Two dynamos, D^1 D^2 , are required. The negative terminal of dynamo, D^1 , is connected with the positive terminal of the dynamo, D^2 , by the wire, a . These conductors are connected with the two dynamos as follows: Conductor, b , is connected with the positive brush of dynamo, D^1 ; conductor, c , is connected with the wire, a , and conductor, d , is connected with the negative brush of dynamo, D^2 , a number of lamps, L , are connected with the conductors, b , c , and lamps, L' , are connected with the conductor, c , d . The central conductor, c , acts as a return for the first dynamo and a lead for the second dynamo. When the number of lamps between the conductors, b , c , and c , d , is equal, no current passes along the conductor, c , either from or toward the lamps or dynamos, and under these circumstances the conductor, c , might be disconnected from the dynamos without in any way affecting the results; but when the two groups of lamps differ in number, the difference of current will be carried by the central or compensating conductor.

When two dynamos are combined on this plan, these conductors take the place of four connected up according to the two-wire system.

ACCORDING TO The Engineer the daily total of water supplied to London during last November was 201,281,664 gallons for a population estimated at 6,015,144, representing a daily consumption per head of 33.46 gallons. A large percentage of the water was obtained from the Thames.

Correspondence.

Balanced Cantilever Crane.

To the Editor of the SCIENTIFIC AMERICAN:

In your description of the "Electric Balanced Cantilever Crane," page 85 of SCIENTIFIC AMERICAN, February 10, 1900, you do not state why, when the load is at either end of the crane, the whole machine does not topple over. I am a regular purchaser of the SCIENTIFIC AMERICAN and as this is the first question I have asked you I trust you will see fit to answer. The question is: Why, when the load is at the end of the balanced cantilever crane, does not the entire machine topple over in that direction?

FRANK I. GIVEN.

Hillsboro, N. M., February 20, 1900.

[Replying to the appended inquiry of Mr. Frank I. Given.]

The reason the cantilever does not topple over when the load is at either end of the crane is that the machine itself has stability enough to prevent this; i. e., when the load is at the extreme end of the cantilever the center of gravity of the whole machine plus the load is still quite a distance inside of the base or pier of the machine. The tendency to topple over is further counteracted by the traveling counterweight which is attached to the trolley moving line and which travels on a track immediately above the trolley track. This counterweight is so placed that it moves from the center toward one end of the cantilever at the same time and at the same speed as the trolley with the load travels toward the opposite end of the cantilever.

A further leverage is obtained in the case of heavy loads by adding to the counterweight, and by also placing it half way out on the arm of the cantilever when the trolley is at the center, thereby causing the counterweight to be at the extreme end of the cantilever when the trolley itself is half way out toward the other end.—W. F.]

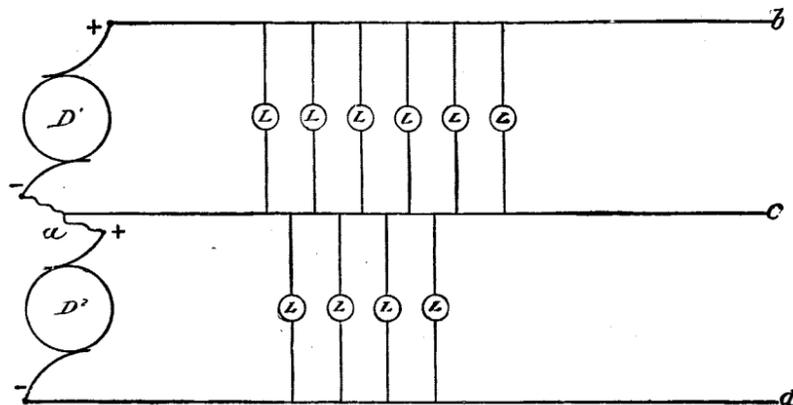

EDISON THREE-WIRE SYSTEM.

lever when the trolley itself is half way out toward the other end.—W. F.]

Ship Propulsion by Liquid Air.

To the Editor of the SCIENTIFIC AMERICAN:

Having read the interesting article on Liquid Air by Hudson Maxim, in your issue of March 17, it seems to me that he has not fully considered the subject. He says, in the first place, "it would require boilers for the evaporation of liquid air," his only ground for this assumption being that it now is necessary to have boilers and furnaces for the boiling of water; but water boils at 212° and air at -340°, and while water has no tension until a temperature of 212° is reached, liquid air confined is at the temperature of surrounding matter and at 60° has a tension of 3,000 pounds. If liquid air were to be used at a tension of 250 pounds nothing would be needed to heat the air; on the contrary, it would have to be cooled to avoid a much greater pressure. Mr. Maxim also says that "liquid air cannot be re-condensed like water," which is true, but it may be re-condensed by using other means of condensation, and instead of 40,000 tons of liquid air being required to propel the S. S. "Teutonic" across the Atlantic five tons will be sufficient if re-condensed. It is unfortunate that such claims have been put forward by the promoters of liquid air enterprises, who have no method of utilizing the same except by exhausting it, and consequently wasting it. But the subject of condensing and re-using it and other expansive gases for motive power is being carefully investigated and a point has been reached and we may be safe in predicting that the operation of a high-pressure condensing gas engine will realize the expectations which Mr. Maxim now derides.

GEORGE H. GILLETTE.

New York, March 20, 1900.

The New United States Cruisers of the "California" Type.

To the Editor of the SCIENTIFIC AMERICAN:

I beg to make a few suggestions in reference to the new armored cruisers of the "California" class I understand that they are to be about 12,000 tons, a speed of 22 knots, an armament of four 8-inch rapid-

firers, and sixteen 6-inch guns. Does this not seem rather light when we consider that the new Japanese cruisers of 9,750 tons displacement (2,300 tons less than the "California" class) are only inferior in gun power by two 6-inch guns.

Why not build ships of the "Bendetto Brin" type of the Italian navy? Her speed of 21 knots is greater than that of the cruisers "Rossia," "Rurik," "Bismarck," "New York," "Dupuy de Lôme," which range from 19 to 21 knots in speed, and equal to the new armored cruisers of the "Cressy" and "Montcalm" classes of the English and French navies. The "Brin's" armament of four 12-inch B. L., four 8-inch R. F., twelve 6-inch R. F. is superior to that of the British "Canopus" by four 8-inch R. F. The armor is the same in thickness as the "Canopus," but excels it in quality (being Kruppized) and speed about 2½ knots greater. To sum up the strong points of this magnificent ship, we find (1) her armament is greater than that of any warship yet designed. 2. Armor equal to that of the average battleship. 3. A speed equal to that of the majority of armored cruisers. 4. Large bunker capacity of 2,000 tons. The cost of our new cruisers is limited to \$4,000,000. Ships of the "Brin" class could easily be built for that sum. The "Maine," though designed for an armored cruiser, was, for all purposes, a battleship. No armored cruiser and few battleships could engage the "Brin" type of ship with any hope of success.

ROBERT F. WOOD.

New York, March 14, 1900.

The Excavations of Ur.

An expedition is now being formed to excavate Ur, and it will be under the direction of Dr. E. J. Banks, who was recently United States Consul at Bagdad. The work will be undertaken for the benefit of the Smithsonian Institution. Ur lies half way between the ruins of Babylon on the Persian Gulf, says The Outlook, and is six miles south of the River Euphrates.

Ur was a great city long before the time of Abraham, and according to the book of Genesis, Abraham was born there as was also Sarah. The Hebrew people emigrated from Ur to Syria. The great temple Gishshir-gal, the home of Sin, or the moon god, is the best preserved of any of the specimens of Babylonian architecture which still stand. The British consul, Mr. Taylor, made some excavations a half century ago resulting in the discovery of the inscriptions of the King Nalondus which speak of the crown prince the Belshazzar of the Bible. The most modern town in Babylon is Nasaria and it is only half a mile away from the ruins, and the inhabitants are beginning to dig bricks from them, destroying the tablets and defacing the inscriptions.

The present appearance of Ur is that of three stories of an ancient temple rising 70 feet above to plain; surrounding the temple is a group of mounds half a mile in diameter. The ruin of the city is called, in the Bible, Ur of the Chaldeans. The estimated amount required for the complete excavation of Ur in two years is \$50,000.

The Use of the Divining Rod in the Search for Water.

At last the divining rod is to be scientifically investigated. A commission has been appointed in France to study all apparatus and methods employed by sorcerers, water seers, and wizards, who use the divining rod, mineral rod, exploring pendulums, hydroscopic compasses, and the other instruments which go by a host of other fanciful names. The French engineer, M. Brothier de Rollière, is the president of the commission. He will procure divining rods of all kinds, including books, reviews, journals, reports of experiments, together with the names and addresses of the inventors of the alleged devices. All the facts and documents may be sent to M. de Rollière, care of Cosmos, 8 Rue François Premier, Paris, France. It is to be hoped that the findings of this commission will, once for all, settle the question of the divining rod, not only for the discovery of water, but also minerals. In England, particularly, the water diviner plies his lucrative profession without legal interference, and, strange to say, his dupes are often town authorities. The whole business is akin to that of fortune teller, the spiritualist, or any other charlatan, and it is strange that the exponents of such systems are allowed to openly pursue their avocations undisturbed by fear of prosecution. At present the victims are the only ones punished.

The Estate of an Inventor.

That inventors very often leave large estates is shown by the fact that Prof. D. E. Hughes, F.R.S., the inventor of the Hughes printing telegraph and other important electrical appliances, left an estate valued at \$2,365,000. The greater part of it was left to hospitals in London. A considerable sum was also left to various scientific institutions. The hospitals will receive about \$2,000,000.

Science Notes.

The German army authorities are now experimenting on a cotton stuff as a material for balloons. It is treated with rubber before being used. The fabric is said to have great strength, and is better than silk which is apt to generate electricity.

A consignment of vegetables grown on the farms of the Cuban Industrial Relief Commission have arrived and they have met with high favor. The potatoes are said to be superior to the best Bermudas as they have not the insipid sweetness of the Bermudas and are more mealy.

Unvulcanized India rubber is by no means waterproof. Rolled plates of rubber were found to be capable of taking up in two hours from 8 to 35 per cent of water at 60° centigrade, the absorption increasing with the degree of compression, and a piece of best Para rubber kept under the water at 50° was nothing but a mass of slime in two months.

In an English contemporary we find the following advertisement of a shooting school: "40 acres in extent. Gun fitting a specialty. Instructions in the art of shooting. Patent try guns and targets. Most realistic coverts. Practice at driven birds, high pheasants, etc. Any number of sportsmen can be accommodated. Experienced gun fitters and instructors always in attendance."

The way in which the Indians made soapstone dishes is said to be as follows: With a hard implement, probably a flint, they cut a circle on the stone which was to become a dish and then chipped away and down on the circumference of this. They then fashioned the outside to the shape they desired, while it was still attached to the rock itself. Finally, they split it off at the bottom and hollowed it out, and the dish was completed.

Gas liquor has been turned to a very useful account at Cuzzies, in France. Beet root would not grow in the fields because they had become infested with a beet root parasite, but with one application of the gas liquor 15 tons of beet root per acre, with 14 per cent of sugar, four splendid crops of cereals were obtained, and in another set of trials using gas liquor only, four successful crops of more than 24 tons to the acre and a fifth of over 16 tons were secured.

The New York Times will publish an American newspaper on the grounds of the Paris Exposition. It will appear in its usual form and will be printed on a large, latest improved web-perfecting press and a complete printing office, including a battery of type-setting machines, will be installed in the center of the American Annex to the Building of Liberal Arts and Mechanical Industries. It will be gratuitously distributed at the place of production and it will be the only paper published on the Exposition grounds.

M. Ach, in the *Zeitschr Instrumentenk*, describes an interesting apparatus for the registration of vertical movements. The vertical motions of the center of gravity of a ship at sea are recorded photographically by means of an aneroid barometer carrying a mirror instead of a pointer. The limit of accuracy of the records obtained is about 1 m., which corresponds to an ordinate of about 2 mm. on the curve. Greater accuracy can be obtained by using a micrometric eye piece. The apparatus is suspended by a double cardani suspension.

The project for building a new façade to the cathedral of Milan which has been at the point of execution for fourteen years, is receiving so much opposition that it is not impossible that it may be abandoned. The old façade struck a discordant note, but many of its details were very fine. As the bequest which was to pay very largely the cost of the construction of the façade was to revert to the great hospital at Milan if the construction was not begun within a certain time, it is probable that the Milanese public will not regard the loss of a new façade a very serious matter.

An ingenious arrangement to prevent over-crowding of both elevators or stairways is in use in the offices of the International Correspondence School, Scranton, Pa. The time of entering and leaving the building is regulated by clocks on each of the five floors. On the lower floors the clocks are set correctly but on the upper floors they are a few minutes slow so that the employes on the lower floors are at their works before those on the upper floors are due and of course those on the upper floors do not leave their desks until several minutes later, thus avoiding all confusion.

It is possible that Sierra Leone will be a good source of supply for India rubber. The native collectors in their endeavor to increase the yield of rubber are now frequently bleeding the roots of the tree as well as the body. This is said to be fatal to them, and at the same time the rubber gathered from this source is of inferior quality. It is suggested that this inferior root rubber should be refused altogether by buyers in the local market and in turn by the foreign markets, in order to prevent the destruction of the forests. Unfortunately the demand for raw rubber prevents this being done. The government and officials are fostering a plan for planting rubber trees and vines in the colony.

Engineering Notes.

It is proposed to establish Chinese commercial schools in England which would be assisted by the government, and which would train young men for service in the Chinese export trade.

Plans for the reclamation of the meadows near Newark, N. J., are being considered, and thirteen plans were submitted. The plans were sent in by experts and engineers from all parts of the country.

The power plant of the Paris Exposition has a chimney 289 feet high, 26 feet is below the surface of the ground and 263 feet is above the ground. The foundation rests upon an oak piling capped with a concrete block 59 feet in diameter and 5 feet thick. Upon this is built a truncated cone of masonry 54 feet in diameter at the base and 42 feet in diameter at the top, and 18 feet 6 inches high. Into the hollow space in its interior opens the tunnels conveying the smoke and gases from the various boiler plants. Above the ground line, the chimney consists of a pedestal 52½ feet high, a shaft 177 feet high and a capital 33 feet high. The chimney is built of white brick ornamented with bands, lozenges, crosses, etc., in red, black and enameled brick. On the whole the smokestack is most excellent from an architectural point of view.

The New York and Ottawa Railroad will be completed during the present year, and will be one of the most important routes between the United States and Canada. This road now runs from Cornwall to Ottawa (about 57 miles), and from Hogansburg to Tupper Lake (about 65 miles), and the intention is to extend it 60 miles to North Creek, and there connect with the Delaware and Hudson and New York Central at Albany. This line gives a direct connection from Ottawa to New York, Boston, Saratoga, Adirondacks, Lake Champlain, Massena (where millions are being spent in making a canal from the St. Lawrence to Grass River), and other points. The run from Ottawa to New York will be made in about ten hours—one and one-half hours less than the time from Montreal to New York. The placing of the northwestern portion of New York, Massachusetts, and Connecticut in such close touch with the Dominion, especially with the Province of Ontario, cannot but produce good results to both countries and largely increase the trade between the United States and Canada.

Consul General Mason, of Berlin, under date of February 13, 1900, sends the following translation from the *Fränkische Courier*, Nuremberg, February 6, 1900:

The Bavarian State Railway Administration has addressed a letter to the locomotive manufacturers, Maffei & Krauss, at Munich—from whom it has received heretofore its entire supply of locomotives, and who have been naturally surprised by the order for locomotives from America—stating that these machines are imported from Philadelphia solely for the purpose of enabling the many details of construction wherein they differ from German locomotives to be studied, and, so far as may seem advantageous, adopted in the future construction of engines for the Bavarian State railways; for the newly imported machines show, as the general direction further explains, in many respects important variations from the construction which is usual in Germany, especially in respect to the boiler, cylinders, and frame construction, dimensions of the axles, valves and valve gearing, the couplings and buffers, while, on the other hand, other parts are not as carefully worked out as is customary in German locomotives. The general direction will, therefore, give the Bavarian locomotive builders full opportunity to familiarize themselves with the construction of the American machines, and invite the makers to have them carefully studied by their engineers.

The plans for the improvements in the Red River, about fifteen miles from Winnipeg, call for a dam across the Red River 800 feet in length, a canal 1,900 feet in length, one set of locks 215 feet in length, and dredging in the river for a distance of some 400 feet, says *The Canadian Engineer*. The lock will be 215 feet long, 45 feet broad and the solid concrete will be 38 feet deep, giving the locks a high water depth of 30 feet, while at low water the depth will be 11 feet. The gates of the lock will be of steel. The approach to the locks will be by a canal from a point on the west bank of the river, a distance of 1,500 feet. The canal will be 100 feet wide, and have a depth of 11 feet. The distance to the canal from the river will be partly wooden crib work, filled in with stone and will be 290 feet in length. The canal extends 400 feet north of the lock to the river, which will be dredged to a depth of 9 feet for about 100 yards. The dam to regulate the river will extend from the east side of the locks 800 feet, to a point on the east bank of the Red River. It will be of concrete, granite faced, 32 feet at the base and 18 feet 5 inches at the top. The dam is provided with seven piers and two abutments, and also with sluice gates. The piers and abutments can be used as the base of a service bridge and from this could be worked a system of shutters and movable frames, by which the height of the dam could be increased 12½ feet. The bridge and shutters, however, will form a separate contract.

Electrical Notes.

It is stated that the authorities at Scotland Yard are now engaged in subjecting a police electric lamp to practical tests, to ascertain if it will stand the necessary wear and tear of the service.

A French inventor, M. Mercadier, states that he has solved the problem of sending a number of despatches simultaneously on a single wire. Messages have been transmitted between Paris and Pau. Twelve independent message currents were sent on the circuit at once in either direction, making a total of twenty-four telegrams.

The Rhodesia telegraph system, including trans-continental line, consists of 2,635 miles of lines with 3,163 miles of wires, says *The Western Electrician*. The police telephone system consists of 251 miles of telephone; exchanges have been opened at Salisbury and Bulawayo. There are sixty-two telegraph offices in Rhodesia.

The temperature of electric incandescent lamps recently formed the subject of a communication to the Paris Academy of Sciences by M. P. Janet. The variation of the resistance of the lamp as a function of the difference of potential at the ends of the filament is measured, and also the variation in the resistance of a cooled lamp as a function of the time. From these, with the weight of the filament, the temperature can be deduced, assuming that the filament is composed of pure carbon. Four lamps gave concordant figures, namely, 1610°, 1630°, 1620°, and 1720° Cent.

Zinc plating on iron acts quite differently from iron plated with other metals, such as nickel, silver or copper. Zinc protects the iron electrically by virtue of the fact that in the presence of moisture a galvanic couple will be formed between the zinc and any exposed parts of the iron, which will cause hydrogen to be formed on the exposed iron, and this tends not only to keep rust from forming, but will also reduce any rust which may have been formed. To successfully plate iron with zinc is, therefore, much more important than to nickel-plate it, but unfortunately, it is much more difficult. The following recipe from the *Zeitschrift fuer Elektrotechnik* may, therefore, be of interest: The bath should have a specific gravity of 1.135, or contain about half a pound of zinc sulphate per quart of water. Its current density should be about 0.1 to 0.2 amperes per square inch, and the solution should be kept stirred. The articles must be very carefully cleaned before plating, and the bath should be replenished with a mixture of zinc dust with about twice its weight of powdered coke, suspended in a bag.

W. J. S. Lockyer in *Nature* discusses the possibility and probability of the objective existence of dark flashes. He remarks at the outset that many apparent dark flashes as seen by the eye are probably due to retinal fatigue, and so have only a subjective existence. Photography also may be deceptive, owing to the phenomenon of photographic reversal. A. W. Clayden, in 1899, put forward the following explanation of the apparent dark flashes shown by photography. If the lens be covered the moment after a flash has occurred, the developed image is always bright. If, however, after the flash has passed, the plate be exposed either to the continued action of a feeble diffused light or to the powerful glare arising from one or more subsequent flashes, then, on development, the image of the original flash will probably come out black. The present author then proceeds to test this explanation as applied to a number of very striking photographs exhibiting bright and dark flashes. He also took photographs of sparks from an induction coil with and without subsequent exposure to light reflected from burning magnesium. The examination of all these cases leads to an entire corroboration of Clayden's hypothesis.

In a recent number of *The Journal of The Franklin Institute* a paper, by Messrs. R. B. Williams and J. H. Klinek, on a "Photometric Comparison of Illuminating Globes" is given in full. The authors experimented with great care on a large number of globes and reflectors used in connection with the Welsbach gaslight. In order to ascertain what these actions were, the authors made photometric measurements at different angles in a vertical plane for the same light, with and without the globe or reflector. In this way polar curves were obtained by which the actual efficiency of the globes was calculated. As an example of the result when using a Holophane globe, the area of the curve above the horizontal line was decreased from 12.58 to 7.92, while the area of the curve representing candle-power below the horizontal line was increased from 11.15 to 12.72. The mean spherical candle-power of the light without the globe was 46.46, while it was decreased by the globe to 41.28. This gives the efficiency of the globe as 87 per cent. This efficiency must be considered together with the fact that the light given off below the horizontal line was actually increased, and that this light is the more useful. Similar curves are given off for enclosing globes of different shapes, and for a large number of reflectors. The curves obtained are most valuable for reference, and make it clear how important it is to select the right globe for a given situation.

FERRY STEAMER WITH AN ELEVATING DECK.

The city of Glasgow, like many of the maritime cities of the world has to deal with the question of harbor ferriage, and in this case it is complicated by a considerable rise and fall of the tide. The construction of a ferry boat is a simple matter in itself, and calls for no particular engineering skill. The difficulty arises in making a suitable connection between the ferry boat and the shore at the various landings. The usual method of accommodating the variations in tide level is that which is adopted in New York city and vicinity, which consists in the provision of floating pontoons at each landing whose deck is always at approximately the same level as the deck of the ferry, the pontoons being connected with the shore by a hinged bridge gangway. Bridges, of course, are the most desirable method of crossing a waterway; but if they are to be used in place of ferries across a river which, like the Clyde, is crowded with shipping, great expense is incurred in having to either build a high level bridge or some costly form of swinging, roller or lift bridge.

The ferry which is shown in our illustration was constructed for service at Finnieston, in Glasgow harbor, at a point which is about equidistant between the Glasgow bridge and a ferry which is running at Govan, at which latter place there are sloping slipways to allow vehicles to pass to the ferry at all stages of the tide. In order to avoid the well-known inconvenience of a sloping slipway, the "Finnieston," as she is called, was built with an elevating deck which can be raised or lowered by bevel and worm gearing so that the deck may be brought to the same level as the quay at all stages of the tide. The vessel is 80 feet long and 43 feet broad, and she maintains approximately the same beam throughout her whole length. When in its lowest position, the elevating deck, rests upon the iron main deck of the boat, leaving the sides clear for the smokestack, steering gear, etc. The elevating deck is 78 feet long, and its breadth is 32 feet. It is divided into a driveway, 19 feet wide, for vehicles, upon which are laid two tracks for the accommodation of the railway cars, and two 6-foot sidewalks, one at each side. The deck is raised and lowered by means of six vertical screws, three on each side, and these are supported by six double steel, box-girder columns, 12 inches by 14 inches in sections, arranged in pairs, as shown in the illustration. Within each column is a 6 inch screw of forged steel, which turns at the level of the steel deck in a flanged socket, while at the top each of the screws works in a manganese bronze casing, which is bolted to the inside of the box columns. The clear lift of the platform is 14 feet. The nuts, which are of manganese bronze, are enclosed in steel castings which fit in between the pair of box-girders which forms each column, and are provided with guide bars which work against girders and serve to keep the nut-box in place. The elevating platform is carried on two fore and aft girders, 13 inches in depth, which are bolted to the nut casting. The floor beams of I section are 5 inches in breadth by 9 inches deep, and are spaced 3 feet center to center. The box girders of the elevator frame, on each side of the vessel, are connected at the top by a 12-inch longitudinal girder, and from the point of intersection of this girder with the vertical posts heavy inclined struts extend to the gunwale of the ship and serve to keep the whole framework rigidly in position. There is also a pair of similar struts at each end of the ferry to afford the necessary longitudinal stiffness.

The hull of the vessel is divided internally into a number of watertight compartments. The machinery for elevating the platform and driving the vessel is situated amidships and on either side amidships is a boiler, each of which is 7 feet in diameter by 7 feet 6 inches long. There are three sets of triple-expansion engines, identical in size and pattern, with cylinders 9 inches, 14½ inches, and 24 inches in diameter, and a common piston stroke of 18 inches. Two of the engines are placed athwartships, one driving a line of shafting which runs fore and aft and operates the port screws at each end of the

vessel, while the other drives a length of shafting for the starboard screws. The third engine is placed on the center line of the vessel between the two propelling engines, and drives a line of shafting which runs athwartship, connecting through spur and bevel wheels with two lines of fore-and-aft shafting, which are geared with the vertical raising and lowering

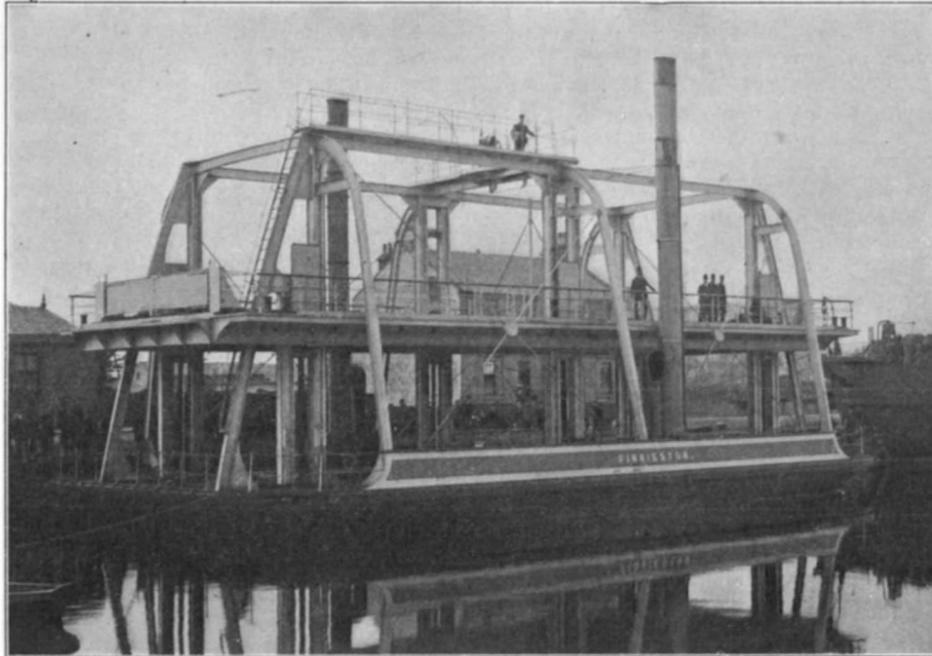

ELEVATING DECK IN THE RAISED POSITION.

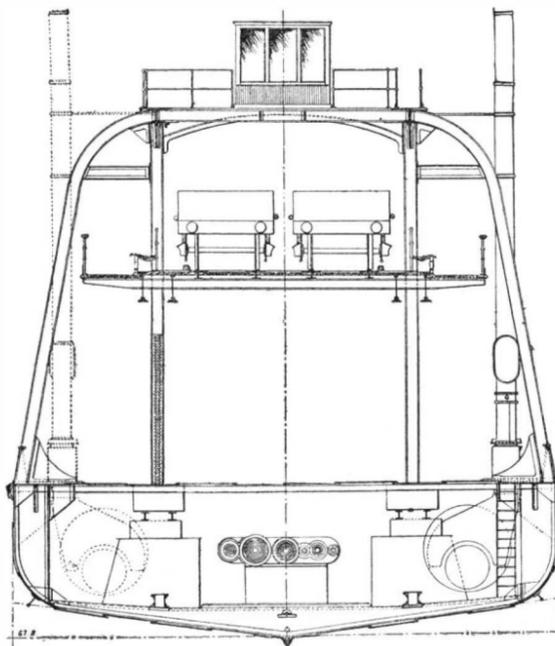

CROSS-SECTION THROUGH THE "FINNIESTON."

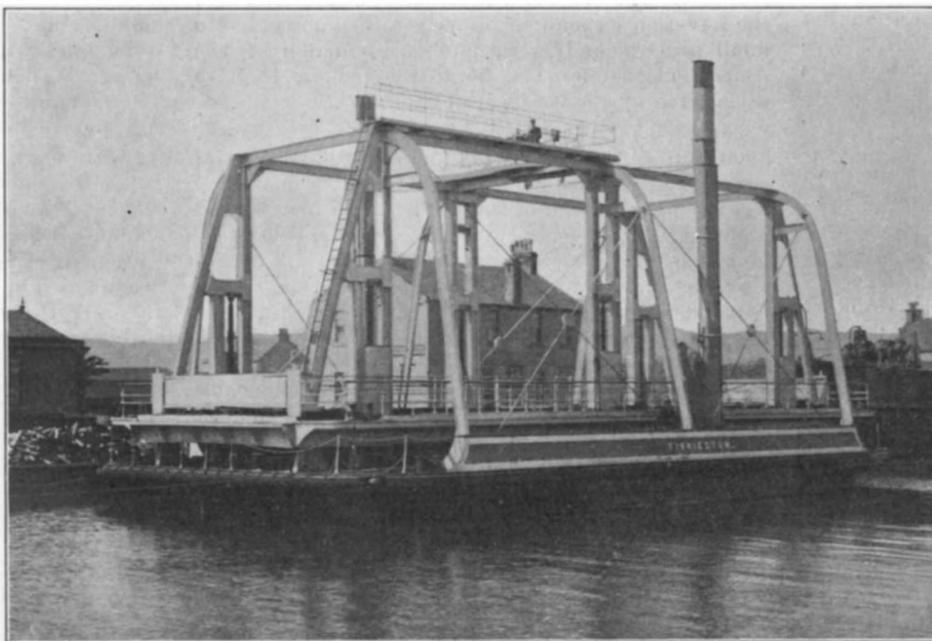

ELEVATING DECK FERRYBOAT "FINNIESTON."

screws of the platform. The "Finnieston" which has accommodation for about 300 passengers and 10 teams, or a capacity of 600 to 700 passengers, if no teams are carried, has proved to be well adapted for the Clyde ferry service.

New Compounds Formed From Boric Acid.

Although normal boric acid should combine with three atoms of a monad metal to form a salt, up to the present time but few compounds of this kind have been formed. M. Ouvrard has recently presented to the French Académie des Sciences an account of his experiments in the formation of metallic borates, in which he has succeeded in producing a number of new compounds. Among the inorganic borates the only one formed up to the present time is the borate of magnesium, $\text{Bo}_2\text{O}_3, 3\text{MgO}$, which has been prepared by Ebelmen, who dissolved magnesium in a great excess of melted boric anhydride, which is then volatilized by the prolonged action of heat in a porcelain furnace. He thus obtained crystals of a pearly appearance, insoluble in water. Analysis gave the proportions corresponding to the above formula. M. Ouvrard describes the attempts of various experimenters to produce the borates of other metals, but their results have been at best doubtful, and it is especially by its organic compounds that boric acid has been definitely found to be tribasic. The experimenter has been successful in preparing a number of metallic borates by the following process. The first tribasic borate obtained was that of cadmium. In a platinum crucible was placed a mixture of fluoride of potassium and boric anhydride, and to this was added oxide of cadmium.

The mixture is heated slowly for some time, and then brought to fusion. Gaseous fluoride of boron is given off, and when this ceases and the mass becomes well fused it is allowed to cool slowly. When acted upon by water, the mass separates, leaving needle-like crystals of cadmium borate. This body presents itself in the form of prisms several millimeters long, which have a marked action upon polarized light. The crystals are not affected by hot or cold water, but are easily soluble in dilute acids. The experimenter describes two different processes of analysis, by which he finds that the compound corresponds to the formula, $\text{Bo}_2\text{O}_3, 3\text{CdO}$. The borate of zinc has also been formed by a similar process. Oxide of zinc is added to the fused mixture of fluoride of potassium and boric anhydride. Upon cooling with care, needle-like crystals are seen to form upon the surface and this action continues throughout the mass. By treating with cold water these crystals are obtained in the form of prisms, which also act upon polarized light. Hot water decomposes these crystals, taking away the greater part of the boric acid and leaving a residue which consists mostly of zinc oxide; the crystals are very soluble in dilute acids. Analysis gives for this compound the formula $\text{Bo}_2\text{O}_3, 3\text{ZnO}$. By substituting the oxide of manganese for that of zinc needle-like crystals are obtained, usually of a brownish color, but transparent and having a marked action upon polarized light. They are not attacked by hot water, but are soluble in acid. By an analogous process, the borate of nickel has been obtained in the form of short prisms of a light green, corresponding to the formula $\text{Bo}_2\text{O}_3, 3\text{NiO}$. The borate of cobalt appears in flattened crystals of a fine rose color.

An Air Brake Patent Upheld.

The petition of the Westinghouse Air Brake Company for a writ of certiorari to review the judgment in the case of the Westinghouse Air Brake Company vs. the New York Air Brake Company was denied by the Supreme Court of the United States on March 19. The Circuit Court upheld the validity of the New York company's patent and judgment was affirmed by the Court of Appeals, and the Supreme Court now refuses to review this judgment.

\$20,000 for an Airship Test.

An anonymous donation has been made to the Aéro Club of France, so that they can offer the sum of 100,000 francs or \$20,000 to the aeronaut, who will start from Longchamps, go round the Eiffel Tower, and return to the starting point, a distance of seven miles in thirty minutes. The competition is to be international. This is one of the most substantial prizes ever offered to inventors, and it is probable that we may look for some remarkable results.

THE BLACKWALL TUNNEL, LONDON.

During the ceremonies inaugurating the work of the construction of the New York Rapid Transit Tunnel, the Mayor expressed himself as being in favor of the extension of the system to Brooklyn by means of a tunnel beneath the East River, and it is the opinion of the Chief Engineer of the Rapid Transit Commission, and of the Commission themselves that such an extension would be entirely feasible. The preliminary soundings, borings and other sur-

vey work are now being done, and it is probable that the Brooklyn extension will be put in hand and built simultaneously with the main tunnel on Manhattan Island.

In prosecuting this important work the engineers will not be entering upon any new or untried field. A large tunnel already exists beneath the East River, at Blackwell's Island, which is 10 feet in diameter and serves to convey the mains of East River Gas Company from Ravenswood to Manhattan Island. The city of London can also boast of several tunnels be-

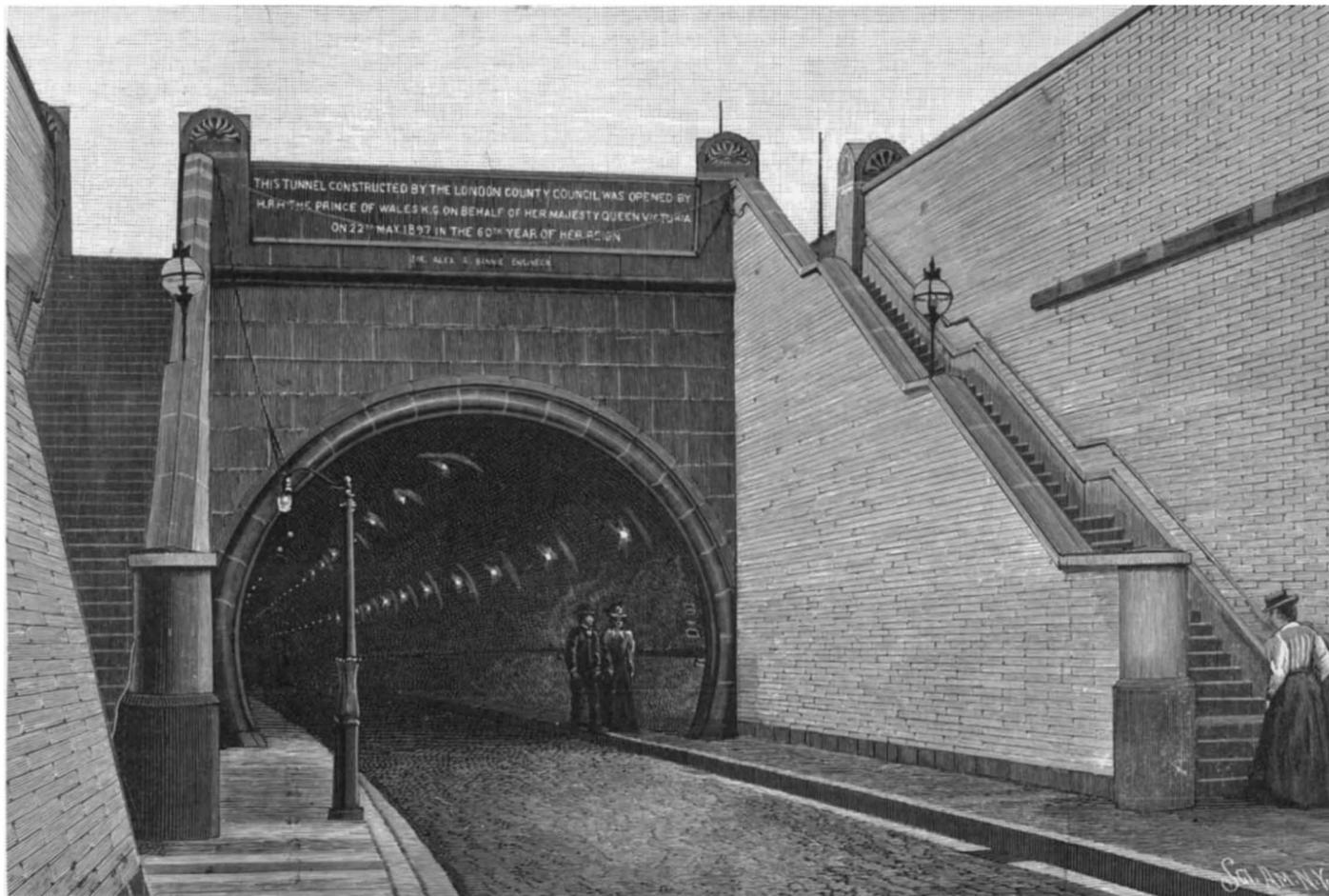

Fig. 4.—ENTRANCE TO TUNNEL ON THE SOUTHERN OR KENT SIDE.

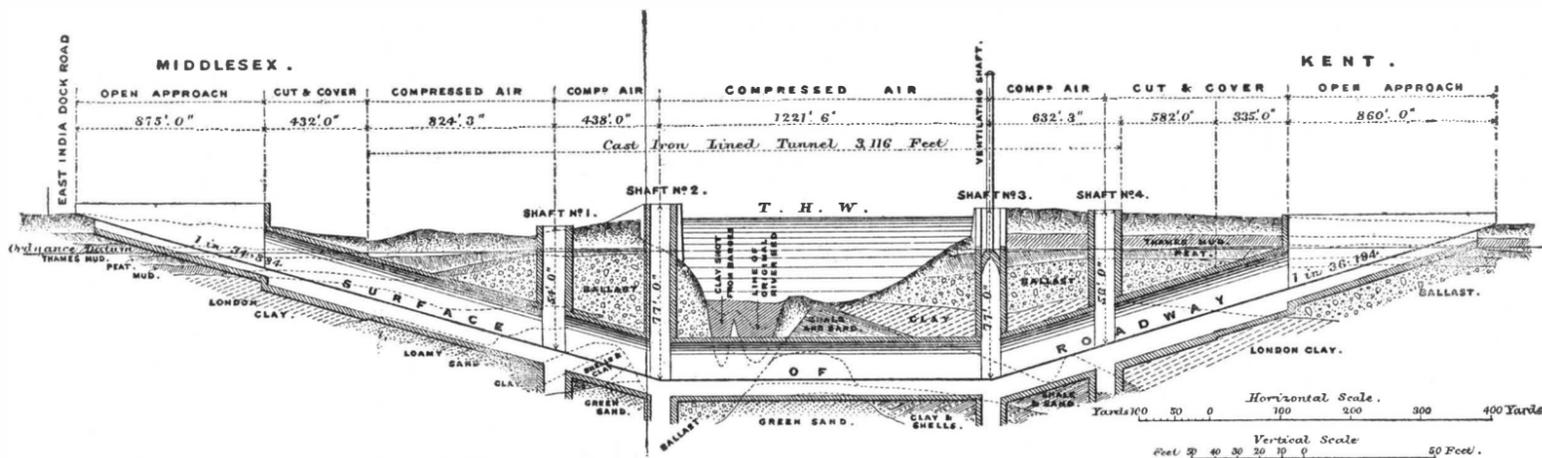

Fig. 5.—LONGITUDINAL SECTION ON CENTER LINE OF TUNNEL.

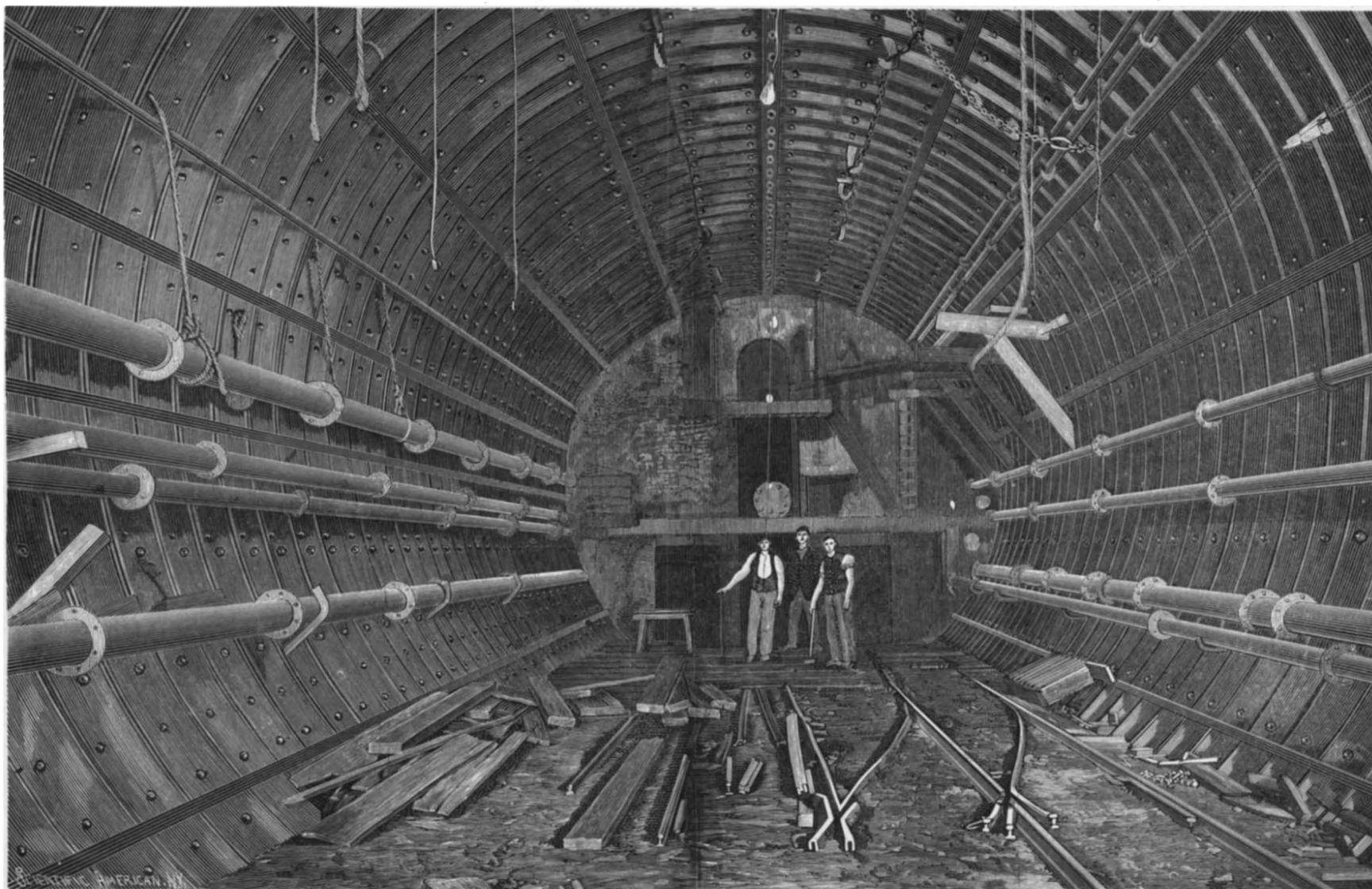

Fig. 6.—INTERIOR VIEW OF BLACKWALL TUNNEL, BENEATH THE THAMES, SHOWING CAST IRON LINING COMPLETED.

neath the Thames River, some for street traffic, and others for the use of various railroads. The most important of these is the great Blackwall Tunnel, which was opened in 1897 and is now in daily use by pedestrians and vehicles. As the methods of constructing this tunnel were similar to those which will be adopted for our own Rapid Transit Tunnel, the accompanying illustrations and some description of the work will just now be of special interest.

It was about the year 1875 that the Metropolitan Board of Works realized the necessity for the construction of more river crossings below London Bridge, and after various schemes, both for bridges and tunnels, had been considered, the Blackwall Tunnel act was passed in the year 1887. The original design called for three tunnels, two for vehicles and one for foot-passengers. It was decided to construct the latter before commencing the others. After considerable delay construction was started on the present tunnel at the close of the year 1891, the contract being let for a round sum of \$4,215,640. We present a longitudinal section on the center line of the tunnel, from which it will be seen that its total length is 6,200 feet of which 1,220 feet is below the river itself. The total length of that portion of the tunnel which is lined with cast iron is 3,112 feet. At each end of the tunnel there is an open approach for about 875 feet followed by 432 feet of what is known as "cut and cover" work on the north side, and by 915 feet of the same work on the south side of the river. Our illustration, Fig. 4, is taken in the open approach and shows one of the entrances. "Cut and cover" is so-called because of the method of construction, which is to excavate an open cutting, build in the brick tunnel, and then fill in above the tunnel, restoring the original surface of the ground. This will be the method adopted for the greater part of the New York Rapid Transit Tunnel. This portion of the Blackwall Tunnel consists of four layers of brickwork, built in concentric rings, and surrounded by a waterproof band of asphalt, one and a half inches thick, with a thick coating of 6 to 1 of cement concrete outside of the asphalt.

To facilitate the work four large shafts were sunk in the line of the tunnel, two on the north side and two on the south side of the river. The sinking was done by means of huge caissons, which were 58 feet in external diameter and were formed of two shells with a space of 5 feet between them which was filled with concrete.

After the shafts were sunk they were finished off with an internal lining of glazed brickwork, and circular stairways were put in to give admission at these points to the tunnel. Two circular openings were formed on opposite sides of each shaft on the center line of the tunnel, and these openings were closed during the sinking by temporary iron shutters or plugs, which were capable of being removed after the shaft was sunk to make way for the advance of the excavating shield.

The difficulty of driving the tunnel was greatly increased in places by the nature of the material to be passed through. By reference to the longitudinal section, Fig. 5, it will be seen that the material consists largely of what is known as "ballast." This is a gravelly, water-laden, and very loose material, which gave considerable trouble during the sinking of the shafts, and in one or two instances, during the driving of the tunnel, resulted in a serious inrush of water.

The diameter decided on for the tunnel was 27 feet. Two patterns of cast iron lining were used, one 2 inches and the other 1½ inches in thickness both being of the same external diameter. The rings of both sections are 2 feet 6 inches in length and are built up of 14 segments, each of which is about 6 feet long circumferentially. The center section at the top of the tunnel consists of a solid key. All the joints were machined and the segments were joined without any packing between them; but recesses were formed on the inside of the flanges and these were carefully caulked, the joints being thus made perfectly watertight. After the tube was bolted up, it was grouted with cement, the grouting being poured in through tapped holes which were afterwards carefully closed with screw plugs.

The shield, shown in Figs. 2 and 3, was constructed of steel and was designed to meet the exceptional difficulties due to the nature of the ground to be passed through, one of which was the probability of meeting with large boulders trunks of trees, etc., and the necessity for cutting through the hard beds which form the base of the London clay. The total length of the shell was 19 feet 6 inches and the diameter was 27 feet 8 inches. The outer skin was built up of four thicknesses of ½-inch steel plates making a total thickness of 2½ inches and the twenty-eight plates of which it was made up extended the full length of the shield, all the joints, therefore, being longitudinal. The forward half of the shield was stiffened by three horizontal

and three vertical plate diaphragms, which also served to divide the working space into four floors and twelve compartments. The shield was formed with a double shell, one 24 feet and the other 25 feet, inches in diameter, the shells being strongly braced together by circular girders, in the webs of the last two of these holes were cut for the passage of the ram cylinders. For forcing the shield forward 28 hydraulic rams were originally provided. They were each 8 inches in diameter with a stroke of 4 feet. In driving through the wet sand, or ballast, beneath the river, however, this number had to be increased by six other rams, which were 10 inches in diameter, but had a shorter stroke. The maximum water pressure used was 2¼ tons to the square inch, making a total pressure to move the shield when all the rams were employed of 5,165 tons. Upon the rear face of the shield were carried two hydraulic erectors, see Fig. 3, which were used for lifting the tunnel segments into place. The circular motion was obtained by a rack or piston, which worked vertically between two hydraulic cylinders, the rack serving to revolve a pinion on which the rotating arm was carried. This arm was extensible by means of another hydraulic jack fixed in its base. The segments of the tunnel were brought up to the shield upon the two tracks, one on either side of the floor of the tunnel, where they were picked up by the extensible arm, swung around to the desired position, and then thrust out radially into place and bolted up.

The method of starting the tunnel from one of the vertical shafts was as follows: A portion of the cast iron lining, extending to the opposite side of the shaft, was first temporarily built up behind the shield to form an abutment for the hydraulic rams in driving the shield forward. The plug facing the direction in which the tunnel was to be driven was then removed from the tunnel opening, and the shield was driven forward through the wall of the shaft into the surrounding material.

It will be noticed in referring to Fig. 5, that there is a

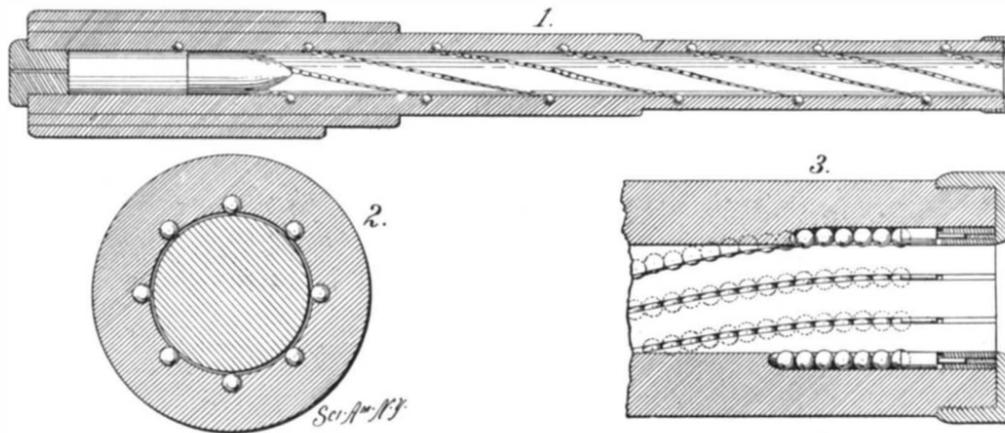

THE LATEST CURIOSITY IN GUN CONSTRUCTION.

layer of London clay between the tunnel and the river bed for about three-fifths of the distance beneath the river. After the clay was passed, what was probably an older and deeper bed of the river, now filled with "ballast," was met with. As was anticipated, there was no difficulty in maintaining a sufficient pressure of air to keep out the water as long as the clay covering continued. In starting from No. 3 shaft the upper part of the shield was in clay and the lower part in sand, and the rate of progress at this point was greater than that in any similar tunnel hitherto constructed, for in two months' time more than 500 feet of the tunnel was completed, and occasionally five rings, or a length of 12 feet 6 inches, was constructed in twenty-four hours. During one day, therefore, 300 cubic yards of material was excavated and about 75 tons of cast iron lining put in place. When we bear in mind that these materials, in addition to lime and other necessities, and empty wagons, had to pass through the air locks, the nature of the performance will be understood.

By reference to the longitudinal section it will be seen that at one point the shield passed within about 5 feet of the bed of the river, the overlying material being open ballast, pervious to water. To meet the difficulty, clay was deposited on the river bed for a length of 450 feet on the line of the tunnel, the maximum depth of the clay being 10 feet. The clay offered resistance to the air escaping from the tunnel through the open ballast, and its weight prevented the bed of the river from being blown up by the air pressure. After the tunnel had been driven through this portion of the river bed, the clay was dredged out.

Shutters for closing the face of the shield proved invaluable when passing through the "ballast" or any open material. In each compartment of the three upper floors were three shutters each consisting of ⅝-inch iron plate, stiffened at the edges by heavy angles, and sliding on guides fixed at the sides of the compartments. The shutters were controlled by long screws fixed to their ends and extending through bearings on the side of the compartment. When working in ballast, previously to shifting the shield forward,

the face of a compartment was completely closed by its three shutters which had been screwed forward as close to the cutting edge as possible, the shutters being directly over each other and the small space between them being filled with clay. When the shield was to be shifted forward, the nuts of the screw were loosened on the forward side of the bearings along the shutters to move back as the shields were shifted forward. Mr. E. W. Moir, M. Inst. C. E., the designer of the shield, to whom we are indebted for our illustrations and particulars, says that the difficulties encountered while driving through ballast suggests modifications in shields for tunneling similar material. The shutters should be placed as close as possible to the cutting edge, and their area in relation to that of the face should be as large as possible. Much of the difficulty in driving the shield was due to this difference of areas and it would probably be little felt in passing through soft material which flows easily, but in gravel the resistance from this cause is very great. In Fig. 2 the shield is shown in position at the end of the "cut and cover" work, ready to commence driving.

All the cast iron lined portion of the tunnel is lined with 4 to 1 Portland cement concrete and faced with white glazed tile, so as to secure uniformity of appearance with the cut and cover portion of the work. The roadway is carried on a 9-inch brick arch, leveled up with concrete. The subway thus formed provides room for water and gas mains, or if it be desired, for a ventilating trunk. The roadway provides for two lines of vehicles and there is a sidewalk for passengers on either side. The tunnel is brilliantly lighted and the effect is greatly assisted by the white tiling with which the whole thoroughfare is lined.

THE CULLEN BALL-BEARING RIFLED GUN.

There has recently appeared in the daily press a description of a so-called ball-bearing rifled gun, which possesses considerable interest both for its undoubted novelty of construction and for the display of ignorance of the very first principles which govern the construction and action of modern guns. The inventor of this curious weapon called at the office of the SCIENTIFIC AMERICAN and informed the editor that the gun had been subjected to exhaustive tests by the government, and had achieved results which were embodied in an official report that was about to be made public. As statements to the same effect have appeared in the articles in the public press above alluded to, the editor was led to make inquiries as to the results reported to have been obtained at the government testing ground at Sandy Hook, and to examine into the claims of the inventor. The latter believes that if the passage of the projectile through the bore can be made more easy, its velocity as it leaves the muzzle will be proportionately increased. Hence he deepens the ordinary rifling, giving it a circular cross-section, and fills it with rows of steel balls.

The claims of the inventor can best be put forward in his own words:

"The strains on the walls of a gun are reduced seventy-five per cent (except over the breech where initial explosion of propellant occurs), thus obviating the necessity for two at least of the jackets that are shrunk over the tube of an ordinary stiff-rifled gun.

"This is to be accounted for in two ways. First: The elasticity of the balls and the smooth-walled projectile; second, from the fact that the projectile gets away from the gun (calculus will prove this in addition to actual trials that have been made) in one-fortieth [sic] (approximately) of the time it takes to get away from an ordinary gun, same charges of propellant and same weight projectiles being used. The life of the gun is prolonged indefinitely.

"The piece has been fired 2,311 rounds, in some cases with excessive charges (and with sand in the ball bearing grooves for ten rounds), and the report shows that the gun is only three per cent less effective than when first fired.

"The average velocity was 3,200 feet per second at the muzzle against 1,800 feet per second for the Driggs and Hotchkiss, and 2,000 feet per second for the Maxim (all of which were tested at the same trial).

"The three guns mentioned were tried in a competitive test with ball-bearing gun by Gen. Flagler and with other ordnance experts, with results which were verified by Gen. Miles' tests."

The statements in the above quotation were so startling, touching the results of the tests, that our Washington correspondent made inquiry at the Army Bureau of Ordnance as well as at the Bureau of Ordnance and Fortification, of which Gen. Miles is the head, and at neither bureau, could it be learned that any such tests as alleged had ever been made. In fact, it was positively stated by a leading official that no such test

as alleged had ever taken place at Sandy Hook or any other government proving ground.

We present illustrations of the gun as being a distinct curiosity showing, as it does, how absolutely Mr. Cullen and the papers that have lauded this invention have failed to understand the elementary principles of the modern rifled gun. Curiously enough they have overlooked the fact that the balls, being locked in by a cap at the muzzle, *could not roll*.

As a matter of fact the velocity would be reduced, and as the shell has no copper rifling band, it would be shot out of the gun without receiving any rotary motion about its longitudinal axis, the mere surface friction between the balls and the projectile being entirely insufficient to overcome its inertia.

So far as the velocity of the projectile is concerned it would be reduced below that of an old black powder weapon. The absence of the rifling-band which, in the ordinary type of gun expands under the pressure of the powder gases, filling the rifling and making a tight gas-check to prevent the white-hot powder gases from rushing past the projectile, would render the gun worse than worthless. The gases would rush through the grooves in which the balls are placed, and through the clearance space between projectile and gun, burning out the balls and the inner tube only less rapidly than streams of boiling water would cut channels in a block of ice.

That such a delusion as the Cullen ball-bearing gun should have been given publicity to such an extent in the public press, leads us to think that either the journals in question were very hard up for matter, or that the "military expert" must have been enjoying a temporary leave of absence.

A FRENCH TROLLEY AUTOMOBILE.

Of late years various attempts have been made to run an electric carriage by current drawn from an overhead trolley wire. The chief obstacle encountered in using an aerial conductor was the difficulty of holding the trolley wheels in contact with the wires, particularly when the vehicle was rounding curves. The results obtained were not very encouraging. The underrunning trolley wheel carried on a pole, could not be used; for the carriage could not turn out of the way of other vehicles on the road. The substitution of a cable for the pole and the employment of a trolley running over instead of under the wires prove no more successful; for the trolley was merely dragged along by the vehicle. These difficulties seem to have been very ingeniously overcome in a system devised by a French engineer, M. Lombard-Gerin, in which a self-propelling trolley is employed, running along at a speed corresponding with that of the vehicle to which it supplies current.

The trolley is driven by a small, three-phase, induction-motor, supplied with current generated by the motor of the vehicle. The trolley-carriage comprises two metal wheels running on the feed and return wires and serving to make the contact. Between these wheels are two insulating, fiber friction-wheels, which engage the motor and thus drive the trolley-carriage. The trolley is driven at a speed slightly greater than that of the vehicle. This small excess of speed is absorbed by the slip of the motor, the slip between the friction wheels and motor, and the slip of the trolley-wheels. Tension on the

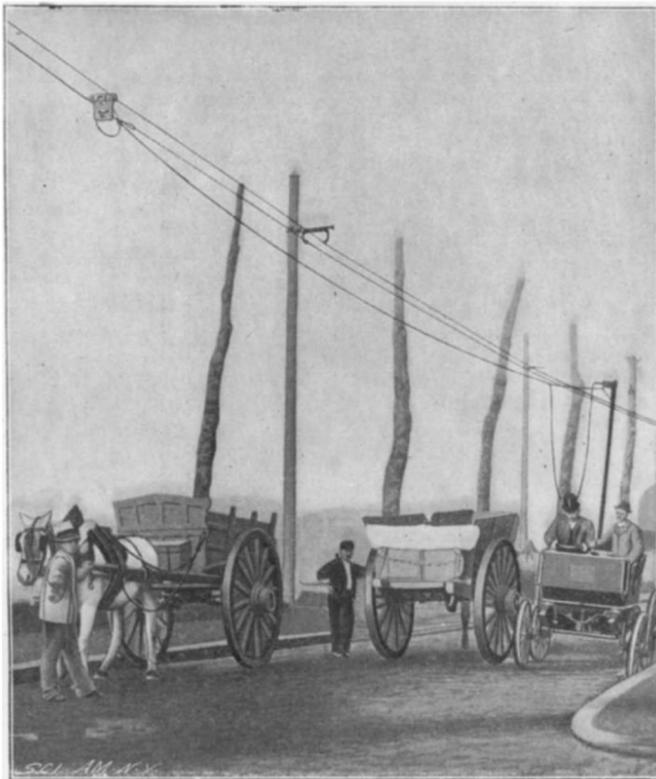

TROLLEY-AUTOMOBILE PASSING VEHICLES ON THE ROAD.

cable increases the resistance and consequently the slips. The trolley-motor is provided with an electromagnetic friction-brake, actuated by current taken from the trolley-line. The trolley-carriage is elastically suspended by means of springs, the tension of which can be regulated as desired. The cable leading to the vehicle is connected with a double frame on the carriage by a universal joint, which enables it to swing in all directions. The entire trolley-carriage weighs only forty pounds (18 kilos.), for the reason that aluminium is largely used in its construction.

The vehicle-motor is of the continuous current, series wound type. At the side opposite the commutator, the armature carries three rings connected with the winding at three points separated from one another

by a distance equal to one-third the angle between two like field poles. The three-phase current generated by the motor flows through three conductors in the flexible cable, directly to the three-phase motor of the trolley-carriage. The speed of the trolley motor depends on the frequency of the three-phase current by which it is actuated; and this frequency in turn depends upon the number of revolutions of the carriage motor. Hence the speeds of the trolley and vehicle motors are practically synchronous; and the trolley carriage automatically regulates the rate of its motion to that of the vehicle.

The flexible cable is composed of six conductors.

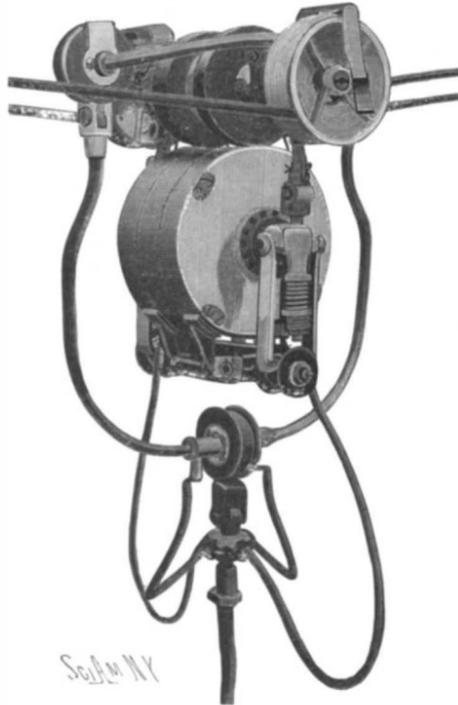

THE AUTOMOTOR TROLLEY.

Two wires of large cross section serve the purpose of conducting the overhead current to the motor of the vehicle. Three smaller wires supply the trolley-motor with the triple-phase current generated by the automobile-motor, and one small wire connected with a pedal in the carriage serves to throw the magnets of the trolley-motor brake into the circuit of the main line. The brake is used when the trolley is running on a steep incline of the wire. The carriage is not essentially different from the ordinary electromobile.

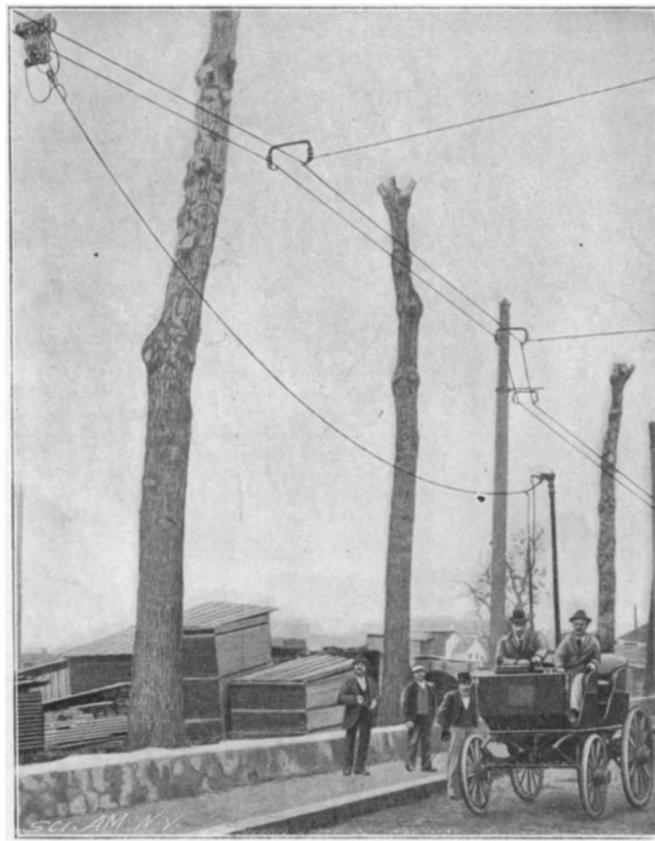

AUTOMOBILE FED BY AUTOMOTOR TROLLEY.

It is provided with a pole which carries at its extremity a junction-box for the reception of the cable. The boxes of the carriages on the line being similar and interchangeable, it is possible for vehicles running in opposite directions to exchange their cables and continue their journey. To permit the trolley to move in either direction a pole-changing switch forms part of the three-phase circuit, so that the connections of two of the conductors can be reversed, to change the direction of the motor's rotation.

M. Lombard-Gerin's system has been tried on an experimental line 900 meters in length, on the Quai d'Issy-les-Moleneaux along the Seine, just outside of the city of Paris. According to Le Génie Civil, the results of severe tests made on this line were very encouraging.

A Congress on the History of Science.

Among the different congresses to be held in Paris at the time of the Exposition, that devoted to the history of science promises to be one of the most interesting. This is a branch of the general section of comparative history and has been organized with a view of bringing together the persons interested in this subject, to establish a resumé of the history of the leading sciences from antiquity to the present day, and to study the proper methods of increasing the researches founded upon original documents. The organization committee have proposed a certain number of questions to be considered, the intention being not to make an exhaustive study of each, but rather as showing where the support of new documents and researches will be the most desirable. Among these may be mentioned the following: Origin of modern numerals; history of astrology, relating especially to the influence which its doctrines have exercised upon the development of astronomy; history of the establishment of units of measure; ancient mathematical instruments, applied to surveying, astronomy, measure of time, etc.; divers meridians of longitude; establishment of the principles of dynamics; alchemy and chemistry; ancient and modern philosophical and scientific theories; geology and physical geography in antiquity; evolution of anthropology and paleontology; history of medicine and hygiene. Communications may be submitted in the principal languages, and in this case notification should be given before the first of June.

The April Building Edition.

The April issue of the BUILDING EDITION OF THE SCIENTIFIC AMERICAN is one of the finest numbers ever published of this artistic periodical. The colored plate represents a modern residence at Plainfield, N. J. A residence at St. Louis, Mo., is illustrated by a number of views showing the exterior and the beautiful interior. The Architectural League exhibition forms the subject of two engravings. Prof. C. F. Holder has an article entitled "The Old Missions of California on the Old King's Highway." It is accompanied by an exquisite full-page group showing four of these interesting old buildings. There is also an unusual collection of moderate priced houses. The literary contents afford good reading.

The Current Supplement.

The current SUPPLEMENT, Number 1266, has many articles of unusual interest. "The Sewerage Problem of the City of Worcester" describes a most important plant which has been in successful operation for some time; it is fully illustrated. "English Artillery in the Transvaal" is a timely article. "Destroyers for the Japanese Navy" is accompanied by illustrations of one of these little vessels making a speed of 31.15 knots. "The Classification of Warships" is a most important article by Frederick P. Jane. "The Bird-Stone Ceremony" is an abstract of a monograph by Prof. Warren K. Moorehead and is fully illustrated. "Is the Steering of the Modern Screw-propelled Vessel Defective?" is the conclusion of a valuable article by the late Capt. Cornelius W. McKay. "Tooth Powders" gives the method of making them in great detail.

Contents.

(Illustrated articles are marked with an asterisk.)

Acetylene for autocars.....	212	Entomology, work of the division of.....	210
Air brake patent.....	216	Ferry steamers*.....	216
Asbestos mines*.....	213	Gas, duty on natural.....	215
Automobiles in German postal service.....	210	Inventor, estate of.....	214
Automobile trolley.....	219	Iron and steel, exports of.....	211
Ball bearing gun*.....	218	Liquid air, ship propulsion by.....	214
Boric acid compounds.....	216	Locomotives in Germany. American.....	213
Bottle, non-refillable*.....	212	Mantles, incandescent*.....	212
Building edition, April.....	219	Meteorite, the Feary.....	212
Canal improvement, obstacles to.....	210	Patent Office exhibit.....	211
Color photography, Trillot on.....	211	Pepper, death of Prof.....	211
Commissariat, changes in the assistant.....	210	Ship propulsion, problem in*.....	213
Congress, science.....	219	Supplement, current.....	219
Cross balance, quadrant.....	214	Three-wire patent, American*.....	214
Cruisers, United States.....	214	Tunnel, Blackwall*.....	209, 217
Divining rod, the.....	214	Dr. excavations of.....	214
Engine, armored*.....	212	Vegetables, Chinese.....	211
		War, hypothetical.....	212

RECENTLY PATENTED INVENTIONS.

Agricultural Implements.

HAY-PRESS HORSE-POWER. — CHRISTIAN F. KOHLRUSS, Augusta, Ga. The invention is an improvement in horizontal, rotary horse-powers in which a horizontally-moving pitman is operated by a horizontal rotary horse-power, giving two full actions to the pitman at every revolution.

LAND-WHEEL ATTACHMENT FOR SULKY-PLOWS. GEORGE A. LITZENBERGER, Sunbeam, Ill. The inventor has devised means for connecting two land-wheels with a mounted or sulky plow, so effecting the attachment that the position of the plowshares is not changed relatively to the ground when the land-wheels travel over an undulating surface, enabling the implement to work perfectly either crosswise or lengthwise with the ridges and hollows of corn rows.

Electrical Apparatus.

CONTINUOUS-CURRENT TRANSFORMER.—ALFRED WYDTS and GUSTAV WEISSMAN, Rue Chaptal 3, Paris, France. The principle of the invention consists in rendering a continuous current alternating in order to enable it to be readily transformed by means of electromagnetic induction, the secondary alternating current of this transformer being then rectified by means of a commutator operated by the same mechanical device as that employed for rendering the original continuous current alternating, in such a manner that the secondary alternating current is rectified isochronously, because the phases of the secondary current, although lagging behind or displaced relatively to those of the primary current, are isochronous with them—that is, the intervals separating the phases of the secondary current are equal to those separating the phases of the primary current.

ARC-LAMP.—EDWARD L. BROWN, McComb City, Miss. The inventor has provided a simple, ingenious device for automatically regulating and controlling the carbons to produce a constant light. The device is particularly adapted for search-lights, magic lanterns, and the like. The mechanism consists of spring-actuated gearing which is operated automatically as the current is cut out by the burning away of the carbons.

Engineering Improvements.

PACKING.—JOHN J. MOSS, 640 South Fairfield Avenue, Chicago, Ill. The packing is useful both for packing rods and joints and for various forms of machinery. The packing removes a certain amount of friction on the rod, and works automatically to the slightest friction. It can be placed in any position and oiled like a brass bushing. A packing-sleeve, comprising a spiral, is connected at one end with the stuffing-box. The other end of the sleeve bears between a spanner and the stuffing-box and serves continually to maintain the spiral under pressure.

Mechanical Devices.

FIRE-ESCAPE.—CHARLES H. SHIELDS and ALVIN SHAW, Spokane, Wash. The invention comprises a tubular ladder at each end of which a carrying-wheel is mounted. The wheels run on tracks secured to the building. A platform is attached to the lower end of the ladder and projects outwardly transversely. An extension-ladder is hinged to the platform and is capable of swinging up and down thereon. The carrying wheels are driven by a chain-gear.

DUMB-WAITER.—CHARLES W. HOFFMAN, Manhattan, New York city. By means of the improvements devised by the inventor, the manufacturer is enabled readily to change the cage-supporting rope-pulley to suit the width of the well or shaft and to bring the runs of the rope in proper alignment with the cage and the counterbalancing-weight, without the use of extra guide-pulleys. The arrangement also affords a convenient and simple support for the brake mechanism of the hoisting-drum.

ELEVATOR CONTROLLING APPARATUS.—JOHN J. COOK, Butte, Mont. The apparatus is particularly adapted to mine-elevators and is so constructed that a sure and effective means is provided for holding the elevator, these means being continually under the control of the operator. The car moves past a guide rail. Shafts are mounted on the car, and a dog is attached to each shaft and works with the guide-rail. Gears are attached to the shafts and mesh with rigidly connected racks fastened to a link. A lever, mounted on the car, is pivoted to the link. A hand-latch is mounted on the lever, and a quadrant on the rack, coacts with the hand-latch to hold the lever in the desired position.

WASHING-MACHINE.—CHARLES W. THOMSON, Ontario, Cal. The object of the invention is to provide an improved washing-machine, simple in construction and arranged to enable the operator to pick up and thoroughly wash any part of the clothes without the least danger of injuring the clothes. The machine has beaters and handled arms carrying the beaters. The fulcrum portions of the arms are reinforced; and bushings screw into the reinforced arms.

Railway Contrivances.

DUMPING-CAR.—GEORGE H. LAWRENCE, Middletown, N. Y. The car is a coal-car of the hopper-bottom type, and is provided with a winding-shaft located on the under side of the car and at one side of the dumping-doors. An equalizing-chain is arranged for winding at its ends on the shaft, the chain extending transversely across the dumping-door and having a traveling connection with the car to allow the chain to equalize. Unequal closing of the door and, consequently, loss of coal are thus prevented.

DUMPING CAR.—WILLIAM H. ONION, New Orleans, La. The dumping-car does not require extra track-sections or alterations in the bridge or track upon which it is to be used. A stop or bumper is provided, capable of convenient and expeditious application to a rail at any point in its length. The car is so constructed that upon striking the stop, it will be automatically

dropped to dumping position and a section of the body operated to discharge the load. Means are provided for varying the inclination of the car-body when the load is to be dumped and supporting a car at its discharge end while dumping. The movements of the car are controlled by a cable which is directly utilized for raising a section of the car-body and caused, in connection with the stop, to incline the car-body suitably for dumping.

Miscellaneous Inventions.

WELL-PULLEY.—JAMES FOSTER, Goben, Tex. Connected with a winding drum and its frame is a guide device for a rope, adapted to guide the rope as it is wound upon and unwound from the drum. The guide device is mounted to travel upon a feed screw carrying a driving-wheel. The winding-drum has vertical movement in its frame to gravitate into driving engagement with the driving-wheel. The rope carrying the bucket can be automatically controlled in a manner to insure the rope's being guided to and upon the pulley in raising and lowering the bucket, thus preventing the hoisting-rope's coming in contact with the mud and water that usually accumulate around a well-curb.

PILING.—WILLIAM B. BONNELL and ROBERT F. SMITH, Macon, Ga. The object of the invention is to provide an improved tubular, metallic piling, designed to take the place of the wood piling now generally used in the construction of breakwaters, levees, and the like. The piling consists of a number of metal tubes arranged side by side. Over the upper edges of the tubes a cap is fitted. Through the lower edges of the cap, bolts extend transversely, which engage sundry tubes so as to hold the cap in place and stiffen the positions of the piles. Metal piles are more durable than wooden piles, are stronger, and are not liable to the attacks of insects.

GATE.—JOSHUA TENNANT, Carson City, Mich. The gate is capable of being swung from its swing-post to or from a team or person and of being slid past the swing-post and opened as far as desired. The gate can be raised or lowered while in either its normal position or when slid past the swing-post and held in the position to which it can be vertically adjusted in order to clear any obstructions, or can be held sufficiently from the ground to prevent snow-drifts from rendering the gate inoperative. The gate, in addition to its pivotal-support, has a crane-support, so that it will not be affected by lateral or vertical strain.

LEVELING ATTACHMENT FOR VEHICLES.—JOHN NASH, Dayton, Wash. The object of the invention is to provide a means for adjusting the body of a vehicle (especially a threshing-machine) to a level position, thus preventing the vehicle from capsizing and avoiding the labor of digging pits for the wheels, to level the body. A hinge-section is pivoted at one end to the running-gear and at the other end to a portion of the body. By means of adjusting-devices at each side of the body, the hinge-section can be swung to level the body.

GATE.—JAMES M. ADAMS, Deckertown, N. J. The gate is of the sliding and swinging class and is provided with a simple means whereby it can be adjusted vertically to clear it of snow or to permit small animals to pass underneath and to form a barrier for large animals. Connected with the gate and its foot-post is a guide-rail secured to the foot-post. A head or block is vertically adjustable on the rail and is provided with a perforated lug engaged by a pintle extended from a gate-supporting roller.

FIFTH-WHEEL.—AMBROSE E. ABBOTT, American Fork City, Utah. The fifth-wheel comprises a ring-plate to which springs are attached. Segmental plates are secured to the axle at opposite sides of the king-bolt. Rollers are mounted in depressions formed in opposite ends of the segmental plates. Heads on the ends of the rollers prevent their displacement lengthwise. The use of grease or other lubricant is unnecessary, thus preventing the accumulation of dust and dirt.

APPARATUS FOR PRODUCING DISTILLED WATER.—CHARLES F. CONOVER, Manhattan, New York city. The invention consists of a system of treating water by which it is evaporated and then condensed so as to produce pure water. One object sought to be accomplished is the utilization of waste sources of heat for the evaporation of water and the subsequent condensation of the water so as to form chemically pure or distilled water. The evaporation of the water heated by waste-heat is rendered possible by the employment of a vacuum-pump, which lowers the pressure on the water and causes it to boil at a much lower temperature than when subjected to atmospheric pressure.

Designs.

CANE OR UMBRELLA-HANDLE.—WILLIAM H. SPEARS, Queens, New York city. The design consists in alternate plain and fluted panels, the plain panels being circumferentially continuous and arranged in the same general plane.

CHIMNEY-CAP MEMBER.—JOHN COOPER, Brooklyn, New York city. The design provides a rectangular member for chimney-caps, such as are used on all houses in large cities.

HOLDER.—FRANK A. SMITH, Chicago, Ill. The device is designed to hold hats, coats, umbrellas, and cards. The holder can be nailed to the wall in any desired place.

BOX-BLANK.—EDWARD E. PINKERTON, Sioux City Iowa. The blank is reinforced at certain portions so as to form a box stronger than that ordinarily produced from one piece blank.

STRETCHER-PLATE FOR CARPET-TACKING DEVICES.—CHARLES P. KNAPP, Deposit, N. Y. This inventor has produced a stretcher-plate of novel form adapted to be used in connection with a carpet-tacking device. The plate is of triangular form and has a series of prongs on its lower face adapted to engage with the carpet and stretch the same. The plate is also intended to be reversed when necessary, and by its peculiar form is very useful in stretching carpet in the corners and along the sides of rooms.

NOTE.—Copies of any of these patents will be furnished by Munn & Co. for ten cents each. Please state the name of the patentee, title of the invention, and date of this paper.

Business and Personal.

Marine Iron Works. Chicago. Catalogue free. For bridge erecting engines. J. S. Mundy, Newark, N. J. "U. S." Metal Polish. Indianapolis. Samples free. Yankee Notions. Waterbury Button Co., Waterbury, Ct. Handle & Spoke Mch. Ober Mfg. Co., 10 Bell St., Chagrin Falls, O. Book "Dies and Die-making," \$1, post paid. J. L. Lucas, Bridgeport, Ct. Send for index sheet. Ferracute Machine Co., Bridgeton, N. J., U. S. A. Full line of Presses, Dies, and other Sheet Metal Machinery. Special and Automatic Machines built to drawings on contract. The Garvin Machine Co., 141 Varick St., N. Y. The celebrated "Hornby-Akroyd" Patent Safety Oil Engine is built by the De La Vergne Refrigerating Machine Company. Foot of East 138th Street, New York. The best book for electricians and beginners in electricity is "Experimental Science," by Geo. M. Hopkins. By mail, \$4. Munn & Co., publishers, 361 Broadway, N. Y. Send for new and complete catalogue of Scientific and other Books for sale by Munn & Co., 361 Broadway, New York. Free on application.

Notes & Queries

HINTS TO CORRESPONDENTS.

Names and Address must accompany all letters or no attention will be paid thereto. This is for our information and not for publication. References to former articles or answers should give date of paper and page or number of question. Inquiries not answered in reasonable time should be repeated; correspondents will bear in mind that some answers require not a little research, and though we endeavor to reply to all either by letter or in this department, each must take his turn. Buyers wishing to purchase any article not advertised in our columns will be furnished with addresses of houses manufacturing or carrying the same. Special Written Information on matters of personal rather than general interest cannot be expected without remuneration. Scientific American Supplements referred to may be had at the office. Price 10 cents each. Books referred to promptly supplied on receipt of price. Minerals sent for examination should be distinctly marked or labeled.

(7852) J. A. DeV. asks: Can such a current be passed over a cable, composed of six number 6 wires of the Brown and Sharpe gage for copper wire, that will deliver 200 amperes at 2,000 volts to a motor at the end of the line without danger of breaking through the insulations and forming a short circuit with the returning cable of the same size, which lies close along beside it. The cables to be five miles long and submerged in the sea but protected by gutta percha insulation to an amount that will equal the cables themselves in weight. A. The underwriters allow a No. 6 wire in waterproof insulation to carry 65 amperes. Your six wires could carry about 400 amperes. If the insulation is all right, there is no reason why the return may not lie alongside of the other cable. Much higher voltages are now put in the same sheathing.

(7853) W. J. I. asks: What proportions are required in the building of a dynamo which is 3/4, 7/8 or anything in that vicinity of a horse power? The Edison with a drum armature is the one I want to build. Give all about size of pieces in the armature and commutator plates, and amount of wire and size of it required. Also, give size of the iron cores of the field magnets and amount and size of wire used in the winding of them. A. Your request is too indefinite. You do not even state the voltage you expect to have from your dynamo. We recommend you to purchase Parkhurst's "Electric Motor Construction for Amateurs, price \$1 by mail; or Watson's "One-quarter Horse Power Motor," price 50 cents and follow the plans given there.

(7854) J. E. C. asks: Have you anything on subject of Clarke's wireless telegraphy as per page 213 SCIENTIFIC AMERICAN, issue of April 2, 1898, so one can build the machine. In the issue given above no measurements or data are given. A. We have no plans with details of the instruments used in the Marconi system of wireless telegraphy, so that one could build machine.

(7855) X. Y. Z. asks why the following rule is incorrect for calculating the area of a circle or "squaring the circle." I have no doubt it is fallacious, but why? The area of a circle equals the square of one-fourth of the circumference. A. The area of a circle is found from the formula: Area = πr²; in which π = 3.1416. To apply the rule given above,—The circumference = 2πr (1/4 of circum.) = πr². Substitute for π² its value given above and we have for the area of a circle 24676 R², while the true value is 31416 R². The rule above cannot in any case give the correct area of a circle. Its only fallacy is that it is false.

(7856) S. E. A. asks: 1. What is the exact temperature required to change steam into the gaseous state? A. Steam is already a gas formed by the evaporation of water. The question perhaps is intended to ask for the temperature of the separation of steam into its constituent gases, oxygen and hydrogen. The dissociation of steam begins at 2,200° Fahr. and is complete at 4,500° Fahr. 2. How can the two gases of which it is composed be most easily separated without the use of electricity? A. This is done in great quantities in the manufacture of water gas. Coal is raised to a high temperature in a furnace, which is then closed and the steam is blown through the hot coal, raising it above the temperature of dissociation. The SCIENTIFIC AMERICAN SUPPLEMENT has contained several articles upon this subject. 3. What is the temperature of the oxy-hydrogen blow-pipe flame? A. It is estimated at about 4,000° Fahr. 4. Can oxygen and hydrogen be introduced into the blow-pipe in a mixed state without danger of an explosion? A. They are so mixed in the mixed jet commonly used in the stereopticon. Special care must be had in the arrangement of such a blow-pipe to avoid explosions.

TO INVENTORS.

An experience of fifty years, and the preparation of more than one hundred thousand applications for patents at home and abroad, enable us to understand the laws and practice on both continents, and to possess unequalled facilities for procuring patents everywhere. A synopsis of the patent laws of the United States and all foreign countries may be had on application, and persons contemplating the securing of patents, either at home or abroad, are invited to write to this office for prices, which are low, in accordance with the times and our extensive facilities for conducting the business. Address MUNN & Co., office SCIENTIFIC AMERICAN, 361 Broadway, New York.

INDEX OF INVENTIONS

For which Letters Patent of the United States were Issued for the Week Ending

MARCH 27, 1900.

AND EACH BEARING THAT DATE.

[See note at end of list about copies of these patents.]

Table listing various inventions and their patent numbers, including items like Accountment support, Air compressor, Alarm, and various mechanical devices.

(Continued on page 221.)

"Star" Foot and Power Screw Cutting Lathes
 FOR FINE, ACCURATE WORK
 Send for Catalogue B.
SENeca FALLS MFG. CO.
 695 Water Street,
 Seneca Falls, N. Y., U. S. A.

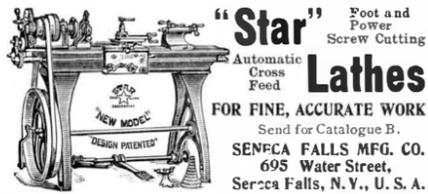

AMERICAN PATENTS.—AN INTERESTING and valuable table showing the number of patents granted for the various subjects upon which petitions have been filed from the beginning down to December 31, 1894. Contained in **SCIENTIFIC AMERICAN SUPPLEMENT, No. 1002.** Price 10 cents. To be had at this office and from all newsdealers.

ENGINE AND FOOT MACHINE SHOP OUTFITS
LATHES TOOLS AND SUPPLIES
SEBASTIAN LATHE CO.
 120 CULBERT ST. CINCINNATI, O.

PHYSICAL AND SCHOOL APPARATUS
INDUCTION COILS for experiments in X rays and other electrical work.
 Catalogue Free.

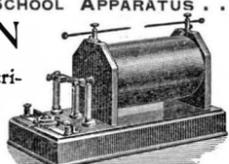

E. S. RITCHIE & SONS, BROOKLINE, MASS.
NICKEL AND Electro-Plating Apparatus and Material.
 THE HANSON & VAN WINKLE CO., Newark, N. J.
 136 Liberty St., N. Y. 30 & 32 S. Canal St. Chicago.

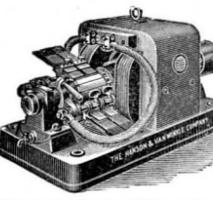

ACETYLENE GAS AND CARBIDE OF Calcium.—All about the new illuminant, its qualities, chemistry, pressure of liquefaction, its probable future, experiments performed with it. A most valuable series of articles, giving in complete form the particulars of this subject. Details of furnaces for making the carbide, gas generators, gasometers, burners, etc. Contained in **SCIENTIFIC AMERICAN SUPPLEMENT, Nos. 449, 1004, 1007, 1012, 1014, 1015, 1016, 1022, 1033, 1037, 1038, 1039, 1041, 1042, 1043, 1044, 1045, 1046, 1047, 1048, 1049, 1050, 1051, 1052, 1053, 1054, 1055, 1056, 1057, 1058, 1059, 1060, 1061, 1062, 1063, 1064, 1065, 1066, 1067, 1068, 1069, 1070, 1071, 1072, 1073, 1074, 1075, 1076, 1077, 1078, 1079, 1080, 1081, 1082, 1083, 1084, 1085, 1086, 1087, 1088, 1089, 1090, 1091, 1092, 1093, 1094, 1095, 1096, 1097, 1098, 1099, 1100, 1101, 1102, 1103, 1104, 1105, 1106, 1107, 1108, 1109, 1110, 1111, 1112, 1113, 1114, 1115, 1116, 1117, 1118, 1119, 1120, 1121, 1122, 1123, 1124, 1125, 1126, 1127, 1128, 1129, 1130, 1131, 1132, 1133, 1134, 1135, 1136, 1137, 1138, 1139, 1140, 1141, 1142, 1143, 1144, 1145, 1146, 1147, 1148, 1149, 1150.** Price 10 cents each, by mail, from this office, and all newsdealers.

PERFECT - PUMP - POWER.
 is attained only in the **TABER ROTARY PUMPS**. They are mechanical, simple and durable. Will pump hot or cold fluid, thin or thick. Requires no skilled mechanic. Most powerful at least cost. All parts interchangeable. Made of iron, steel or bronze. Can be driven by belt, motor or engine attachment. *Large illustrated Catalogue free*
TABER PUMP CO., 32 Wells St., Buffalo, N. Y., U. S. A.



SUB-PRESS PUNCHES AND DIES
 We make to order drawings or models blanking, shaving and swaging dies, either simple or compound, for work requiring accuracy and finish. Sub-Press Dies for the parts of watches, clocks, cyclometers, and other small mechanisms a specialty. We carry in stock different sizes of Sub-Press Bases and Stands. *Send for Descriptive Circular.*
THE PRATT & WHITNEY CO., Hartford, Conn., U. S. A.



THE MIETZ KEROSENE & WEISS and GAS Engine
 burns KEROSENE cheaper and safer than gasoline. Automatic, simple, reliable. No electric battery or flame used. Perfect regulation. Belted or directly coupled to dynamo for electric lighting, charging storage batteries and all other purposes.
 A. MIETZ,
 198-198 Motte St., New York, Markt & Co., London, Hamburg, Paris



GREAT POWER—SMALL COST.
 The maximum of strength, durability and safety, with the minimum of cost that describes our **Hoisting Engines** for operation on Gasoline, Distillate or Crude Oil. Every part of the engine is interchangeable. Soon saves its cost in fuel alone. Both friction and geared hoist, 4 to 120 h. p. For quarries, mines, and docks. **Weber Gas & Gasoline Engine Co., 402 S. W. Boulevard, Kansas City, Mo.**

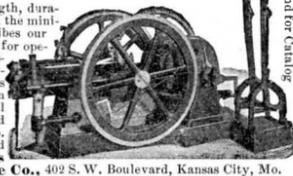

"WOLVERINE" Gas and Gasoline Engines STATIONARY and MARINE.
 The "Wolverine" is the only reversible Marine Gas Engine on the market. It is the lightest engine for its power. Requires no licensed engineer. Absolutely safe. Mfg. by **WOLVERINE MOTOR WORKS, 12 Huron Street, Grand Rapids, Mich.**



BUILD YOUR OWN MOTOR
 Complete Working Drawings of 1 h. p. Jacketless Gasoline Motor in our **EXPLOSIVE MOTOR NUMBER 72** pages. Contains many other interesting articles on Gasoline Motors. Price 10 cents—stamps or coin. **STEAM BOILER NUMBER 73** treats fully of Steam Automobiles. Price 10 cents—stamps or coin. Subscription \$2.00 a year; 6 months, \$1.00. Foreign, \$3.00. Subscribe for a year, from January 1st, and you will get both numbers. *Mention this paper.*
THE HORSELESS AGE, Weekly, Established 1895, 150 Nassau Street, New York.

THE ELECTRIC HEATER.—A VALUABLE paper, with working drawings of various forms of the electrical heaters, including electric soldering iron, electric pad for the sick, etc. 6 illustrations. **SCIENTIFIC AMERICAN SUPPLEMENT 1112.** Price 10 cents. For sale by Munn & Co. and all newsdealers.

This beats Wind, Steam, or Horse Power. We offer the **WHEELER 2 1/2 actual horse power GAS ENGINE** for \$150. less 10 per cent discount for cash. Built on interchangeable plan. Built of best material. Made in lots of 100 therefore we can make the price. Boxed for shipment, weight 800 lbs. Made for Gas or Gasoline. Also Horizontal Engines, 4 to 30 h. p.
WEBSTER MFG. CO., 1074 West 15th St., Chicago.
 Eastern Branch: 38-D Day Street, New York City.
 Southern Agents: Boland & Gachwind Co., Ltd., So. Peter and Lafayette Sts., New Orleans, La.



Electric switch, J. I. Creveling	648,068
Electrical connection device, M. Pfatscher	648,069
Electrical connections, protecting, J. Langton	648,149
Electrical connector, J. Langton	648,150
Electric switch, J. C. Tournier	648,584
Electrolytic apparatus, L. H. A. B. M. Hazard-Plamand	648,281
Elevator, E. M. Prager	648,040
Elevator, J. D. Griffen	648,551
Elevator, C. A. Harkness	648,001
Ellipsograph, E. Tintanne	648,329
Engine, See Explosive engine. Fluid pressure engine. Pumping engine. Rotary engine. Steam engine. Steam or other elastic fluid engine.	
Engine, N. J. Verret	648,985
Engines, electromotors, etc., apparatus for electrically controlling, W. H. Harfield	646,189
Engraving machine diamond holder, pantograph, J. A. Hopp E. Harter	646,177
Envelope, T. W. T. Maxwell	646,186
Explosive engine, J. F. Duryea	646,389
Explosive engine, C. Sintz	646,322
Fabric, See Wire fabric. Woven fabric.	
Fan, ventilating, H. Klein	646,002
Fastening setting machine gage attachment, G. V. Brown	645,938
Faucet, beer, Mitchell & McKinnon	646,056
Feeder for steam boilers, automatic, E. J. Strong	646,083
Feeding device, boiler, F. J. Weiss	646,062
Feeding device for boilers, safety, F. J. Weiss	646,061
Fence machine, wire, M. D. Taylor	646,112
Fender, See Car fender.	
File, letter, H. S. Culver	646,360
File, newspaper, F. C. Blaisdell	646,259
Filing box cabinet, R. W. Pope	646,191
Filing case, card, F. W. Tobey	646,350
Fire escape, ladder, T. F. Kruger	645,582
Fireproofing wood, H. V. Simpson	646,101
Fishing reel, W. Trabue	646,085
Floor cloth, machine for cutting tesserae for, E. Batten	646,346
Fluid interchanging device, H. Szamatolski	646,378
Fluid pressure engine, H. B. Goodhart	646,024
Fluid pressure regulator, R. N. Baylis	646,064
Fly escape, V. D. Muzzy	646,096
Folder, G. P. Fenner	646,273
Folding table, adjustable, H. Mehserle	646,152
Fur cutting machine, J. Derbolaw	646,265
Furnaces, mechanism, for throwing sprays of oil into, T. B. Browne	646,352
Gage, See Water gage.	
Game, M. J. Hotaling	645,955
Game, ball and target, W. R. Park	646,089
Garbage receptacle, W. Bachner	646,163
Gas burner, J. F. Miller	646,000
Gas burner, P. Farmer	646,372
Gas burner, incandescent, A. H. Peteret	646,372
Gas generating apparatus, acetylene, E. Evans	646,272
Gas generator, acetylene, R. L. Beck	646,255
Gas generator, acetylene, Leftwich & Reinken	645,963
Gas generator, acetylene, J. H. Ross	645,710
Gas generator, acetylene, C. V. Yoneman	646,004
Gas generators, valve for water, H. Strache	646,060
Gas igniting pill, A. Martini	646,297
Gas, manufacture of, E. De Fazi	646,019
Gate, See Bridge gate. Swinging gate.	
Gathering iron, D. F. Richardson	646,037
Generator, See Gas generator. Steam generator.	
Glass articles, apparatus for manufacturing hollow, P. T. Sievert	646,133
Glass, treating woven wire in manufacturing wire, J. W. Sheppard	646,132
Gold and silver etc., treatment of, Montgomerie & Parkes	646,006
Gold ores, treating, C. Wetherwax	646,335
Golf club, J. Cran	645,942
Golf club, J. Dalgleish	645,944
Governor, F. M. Rites	646,237
Grain binder, A. J. F. Miller	646,315
Grain conveyor belts and means for operating same, concentrating rolls for, S. F. Evans	645,946
Grave concealing apparatus, G. J. Chaffee	646,083
Grinding machine, Bancroft & Thorne	646,337
Gun, automatic magazine, Beck & Ferrant	645,932
Harvester, attachment, corn, J. P. Derrant	646,002
Harvester, corn, W. Howard	646,219
Harvesting machine, beet, J. I. & A. E. Jackson	645,957
Hay carrier, J. H. Burkholder	646,261
Heel breasting machine, A. G. Brewer	645,944
Hoof pad, W. J. Kent	646,148
Hoof trimmer, E. Morgan	646,058
Hook, See Check hook.	
Horse foot covering, M. Hallanan	646,214
Horseshoe and pad, M. Hallanan	646,213
Horseshoe, cushioned, T. J. Lovett	645,965
Horseshoe, rubber cushion, H. Paar	646,234
Hose, soft tread, M. Long	646,029
Hose pipe, M. H. Hart	646,072
Hub attaching device, Weitzel & Smith	646,245
Hydrocarbon burner, M. O. Godding	646,385
Hydrocarbon motor, E. T. Headach	646,282
Incandescent mantle, compound for coating, A. S. Newby	646,232
Indicator, See Bill of fare indicator. Vessel indicator.	
Induction motor, G. S. Neeley	646,389
Injector, C. S. Taylor	646,111
Ink for marking cigars or tobacco, E. Klein	646,122
Ink well, S. G. Baldwin	646,344
Ink well and reservoir, combined, J. H. Miller	645,988
Inner soles, machine for applying stiffening pins to, J. V. Allen	646,340
Iron, See Gathering iron.	
Jack, Lifting jack.	
Joint, See Radial joint.	
Kite, W. A. Eddy	646,375
Knitting machine, L. N. D. Williams	646,336
Ladder, folding, T. H. Betty	646,347
Lamp, acetylene gas, W. C. Homan	646,052
Lamp, blowpipe, J. Heinz	646,171
Lamp bracket, F. Rhind	645,973
Lamp, flash, K. Kary	646,222
Lamp, portable electric, A. F. Vetter	646,114
Lamp, vapor burning incandescent, A. P. Doran	646,265
Lamps, device for convenient filling of, L. Pagel	646,310
Lantern latch, E. B. Snow	646,136
Last, E. W. Gerrish	646,144
Lat for turning crank shafts, small, H. P. Ledters, etc., extensible pest for transfer, H. P. & H. S. Jones	646,106
Letter or order box, P. A. Bradford	646,016
Leveling instrument, M. Nilson	646,098
Library, pool, and billiard table, S. W. Collins	646,254
Lifting jack, A. J. F. Miller	646,259
Lime, apparatus for making bisulfite of, V. Drewsen	646,268
Liming hoops, machine for attaching, M. J. Bartlett	645,963
Linotyping machine, E. G. Leonard	646,227
Lock, See Cont. door lock.	
Lock and latch, combined, L. H. Mullikin	646,094
Locomotive windows, folding shield or guard for, H. M. Pemberton	646,311
Loom shuttle, D. M. Seaton	646,319
Lubricator, J. F. Lewis	646,076
Lubricator, J. F. Lewis	646,126
Machine case, adjustable, W. B. Leonard	645,934
Match box, J. Ashron	646,342
Match box, J. Schiffeneder	646,130
Mattress filling frame, N. L. Johnson	646,105
Mattress filling machine, C. W. White	646,139
Medical products, making, H. Oppermann	646,364
Metal shears, J. C. Burgess	646,203
Metal sheets, apparatus for picking or cleaning, S. Diescher	646,286
Milk cooler, J. J. McAreavy	645,969
Milking apparatus, Lawrence & Kennedy	646,183
Milling and grinding machine, E. Gessner, Jr.	646,228
Miter box, S. Lewan	646,188
Mold making machine, sand, W. Murchey	646,188
Molds, means for filling, P. Wernicke	645,986
Mortising and boring machine, combined, G. W. Meserve	646,125
Motion mechanism, step-by-step, R. Hundhausen	646,287
Motor, See Air motor. Electric motor. Hydrocarbon motor. Induction motor. Wave motor.	
Motor, H. T. Vaders	646,197
Mower, lawn, W. P. Hill	646,212
Nippers, cutting, R. H. Love	646,294
Nippers for closing metallic rings upon rubber tubing, W. Dewar	646,020
Non-conducting covering, J. Jones	646,289
Noodle cutter, A. V. Lacombe	646,075
Numbering machine, consecutive, O. G. Bartusch	646,047
Nut lock, H. Klemann	646,226
Nut lock, J. V. Stanley	646,050
Nut lock, Wilson & Whitcomb	646,337
Ordnance, apparatus for mechanically loading, J. Kron	646,369
Ore concentrator, W. E. Wiid	645,987
Ore or rock breaking machine, E. Comerford	646,204
Organ, reed or pipe, M. S. Wright	646,406
Pad, See Hoof pad.	
Pail, self heating dinner, H. L. & C. Marlett	646,185
Pail, self heating dinner, H. L. & C. Marlett	646,276
Pan, See Roasting or baking pan. Soap pan.	
Paper bag, O. G. Goodman	646,025
Paper boxes, machine for making, C. W. Gay	645,950
Pen, fountain, W. I. Ferris	646,385

(Continued on page 222)

A Goodform Closet Set
 will make your closet look like this picture. Try it six months. Money back then if you say so.
LADIES' SET—12 Garment Yokes, 12 Skirt Hangers, 2 Shelf Bars and 2 Loops. (See loop on door.)
MEN'S SET—12 Garment Yokes, 6 Automatic Trousers Hangers, 2 Shelf Bars and 1 Loop.
 Sets, \$3.00 each—two in one shipment, \$5.50, express paid. Our Trousers Hanger is much prized by gentlemen; sample 30c.; 4 for \$1.00; 6 and 1 Loop, \$1.50, prepaid.
 Sold in first-class dry goods stores and by clothiers and furnisurers. If you cannot buy them from a dealer in your town, remit to us. Mention your dealer's name. We send free an illustrated descriptive booklet.
CHICAGO FORM COMPANY, 101 La Salle Street, Chicago.

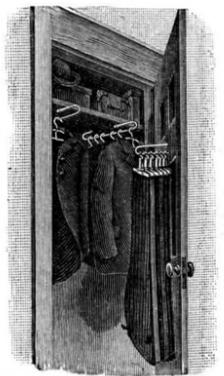

MILLS FOR ALL MATERIALS.
 OUR BUSINESS IS TO MAKE MACHINERY FOR GRINDING GRAIN, CRUSHING ROCKS AND PULVERIZING ALL HARD SUBSTANCES. WE HANDLE ALL KINDS OF MATERIALS FROM COTTON-SEED TO ROOTS AND HERBS. BY AN UNEXCELLED PROCESS. IF YOU WANT ANY KIND OF A MILL OR GRINDING MACHINE, COME TO US AND YOU WILL GET THE BEST AND STILL SAVE MONEY. ESTIMATES FREELY FURNISHED.
SPROUT, WALDRON & CO MUNCY, PA.
 SEND FOR CATALOG NO. 4.

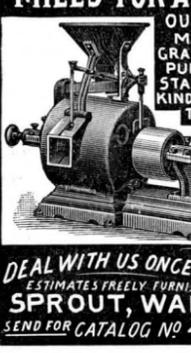

THE BUFFALO GASOLENE MOTOR.
 THIS cut shows our four cylinder, 4 1/2 horse power, non-vibrating, shifting spark, varying speed from 100 to 1,500 revolutions, Gasolene Vehicle Motor, which we have demonstrated to be the most practical power in the market, occupying a space of 18 x 20 inches, manufactured upright or horizontal, total weight 175 pounds. We build from one to eight horse power. For vehicles, boats and light stationary work, we can prove superiority.
 Send for Circular.
BUFFALO GASOLENE MOTOR COMPANY, Dewitt and Bradley Streets, Buffalo, N. Y.

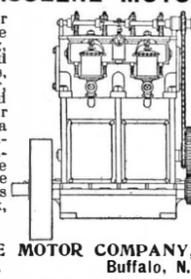

The New Yankee Drill Grinder Scientifically Correct.
 The only drill grinder ever made requiring but one preliminary adjustment. Gage Jaws, Chucks and other fine-consuming apparatus thrown to the winds. Any clearance obtained instantly. Drills cut like razors. A boy can use it. **Iron Workers!** This machine will pay for itself many times each year. Correct work impossible without it. Write us NOW while thinking of it.
THE FULLER MFG. CO., Successors to G. T. Eames Co., 250 Asylum Av., Kalamazoo, Mich.

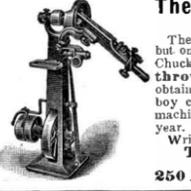

MORAN FLEXIBLE JOINT
 for Steam, Air or Liquids.
 Made in all sizes to stand any desired pressure.
Moran Flexible Steam Joint Co., Inc'd
 147 Third Street, LOUISVILLE, KY.



MONITOR AND MOGUL MARINE GAS ENGINES
LAUNCHES.
MONITOR VAPOR ENGINE AND POWER COMPANY GRAND RAPIDS, MICH. CATALOGUE.



20th CENTURY ELECTRO VAPOR LAUNCH
 This Ideal Gentleman's Launch, elegantly finished, simple, seaworthy, safe, reliable. Seats 8. Speed 6 miles. Guaranteed for one year. Price \$200.00. Order now, avoid Spring rush. Send 10 cents for handsome 76-page catalogue of Steam and Sail Yachts, Launches, Row Boats, Canoes. **RACINE BOAT MANUFACTURING CO., Box D, RACINE, WIS.**

TOOLS OF ALL KINDS
 GOODNOW & NIGHTMAN BOSTON
 Send 10 cents for 128-page illustrated Catalogue.



CROOKES TUBES AND ROENTGENS' PHOTOGRAPHY.—The new photography as performed by the use of Crookes tubes as a source of excitation. All about Crookes tubes. **SCIENTIFIC AMERICAN SUPPLEMENT, Nos. 181, 189, 238, 243, 244, 792, 793, 805, 808, 1050, 1054, 1055, 1056, 1057,** also **SCIENTIFIC AMERICAN, Nos. 7, 8, 10 and 14, Vol. 74.** These profusely illustrated SUPPLEMENTS contain a most exhaustive series of articles on Crookes tubes and the experiments performed with them. Among them will be found Prof. Crookes' early lectures, detailing very fully the experiments which so excited the world, and which are now again exciting attention in connection with Roentgen's photography. Price 10 cents each. To be had at this office and from all newsdealers.

BUILD YOUR OWN ENGINE.
GASTINGS
 CATALOGUE FOR A STANDARD GASOLINE ENGINE S. LAUNCHES
GERE LAUNCH—ENGINE WKS
TRUSCOTT BOAT MFG. CO., St. Joseph, Mich., U. S. A.



ACETYLENE APPARATUS
 Acetylene number of the **SCIENTIFIC AMERICAN SUPPLEMENT**, describing, with full illustrations, the most recent, simple or home made and commercial apparatus for generating acetylene on the large and small scale. The gas as made for and used by the microscopist and student; its use in the magic lantern. The new French table lamp making its own acetylene. Contained in **SCIENTIFIC AMERICAN SUPPLEMENT, No. 1037.** Price 10 cents prepaid by mail. For other numerous valuable articles on this subject we refer you to page 21 of our new 1897 Supplement Catalogue, sent free to any address. **MUNN & Co., 361 Broadway New York.**

Boys
 Does your dad make you take care of his Bicycle Lamp? If so, make him get
The Majestic
 for its the easiest Lamp
TO FILL—because the carbide pot is marked so the quantity is easily gaged.
TO LIGHT—because the water feed is perfectly controlled by a lever.
TO CLEAN—because the reflector and its glass protector are removable by simply pressing a button.
 Send for a catalogue and give it to him.
Edw. Miller & Co., Meriden, Ct.



SUBMARINE TELEGRAPH.—A POPULAR article upon cable telegraphing. **SCIENTIFIC AMERICAN SUPPLEMENT 1113.** Price 10 cents. For sale by Munn & Co. and all newsdealers.

STANDARD STRAINER CO.,
 Dripless Tea and Coffee Strainers.
37-40 MAIDEN LANE, New York.
 Nickel-plated, 25 cents.
AGENTS WANTED. PATENTED AUG 29 1898



DON'T SEW ON BUTTONS!
 Bachelor's Buttons made with improved Washburn Patent Fasteners slip on in a jiffy. Press a little lever—they hold like grim death, but don't injure the fabric. Instantly released when desired. By mail, 10c. each. Ills. catalogue showing collar buttons and other useful novelties made with these fasteners, free on request.
American Ring Co., Box P, Waterbury, Conn.

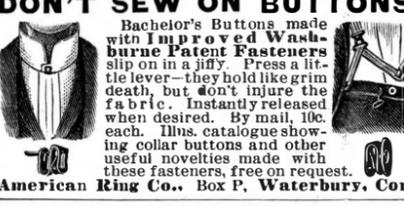

Cyclopedia of Receipts, Notes & Queries
 12,500 RECEIPTS. 708 PAGES.
 Price, \$5.00 in Cloth; \$6.00 in Sheep; \$6.50 in Half Morocco, Postpaid.

THIS great work has now been on the market for nearly six years, and the demand for it has been so great that twelve editions have been called for.
 The work may be regarded as the product of the studies and practical experience of the ablest chemists and workers in all parts of the world; the information given being of the highest value, arranged and condensed in concise form, convenient for ready use. Almost every inquiry that can be thought of, relating to formulae used in the various manufacturing industries, will here be found answered.
 Those who are engaged in almost any branch of industry will find in this book much that is of practical value in their respective callings. Those who are in search of independent business or employment, relating to the home manufacture of salable articles, will find in it hundreds of most excellent suggestions.
MUNN & Co., PUBLISHERS,
 Office of the **SCIENTIFIC AMERICAN,**
361 BROADWAY, NEW YORK.

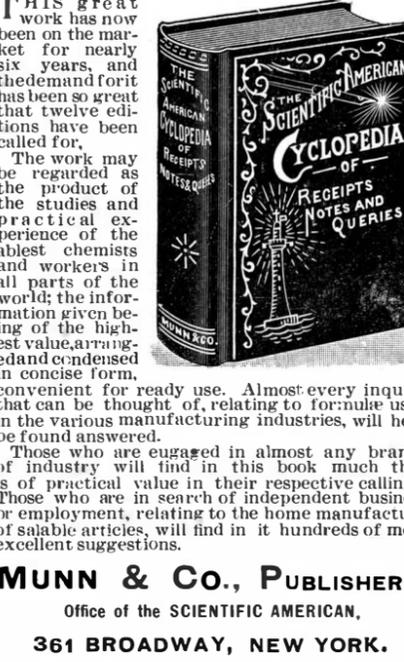

Founded by Mathew Carey, 1785.

HENRY CAREY BAIRD & CO.
INDUSTRIAL PUBLISHERS, BOOKSELLERS & IMPORTERS
810 Walnut St., Philadelphia, Pa., U. S. A.

Our New and Revised Catalogue of Practical and Scientific Books, 92 pages, 8vo.; a Catalogue of Books on Steam and the Steam Engine, Machinery, etc.; a Catalogue of Books on Sanitary Science, Gas Fitting, Plumbing, etc.; and our other Catalogues and Circulars, the whole covering every branch Science applied to the Arts, sent free and free of postage to any one in any part of the world who will furnish his address.



NEW CENTURY

U. S. Department of Agriculture,
WEATHER BUREAU.
WASHINGTON, D. C., Dec. 4, 1899.

In July, 1899, the Weather Bureau purchased forty New Centuries. I take pleasure in saying that after five months' trial they have proven excellently well adapted for the special work for which they were purchased, viz.: that of preparing stencils from which to print the daily station weather maps.

WILLIS L. MOORE,
Chief U. S. Weather Bureau.

The New Century has no superior on any kind of work.

Send for Catalogue.
AMERICAN WRITING MACHINE CO.,
302 Broadway, New York.

Short stories by famous authors, and illustrated by eminent artists, are published in every issue of **COLLIER'S WEEKLY**.

COLLIER'S WEEKLY has a circulation of over 200,000 copies per week—the largest of any periodical in the world that sells for \$3.00 or more per year. For sale on all news-stands. 10 cents per copy. Sample copy free. Address COLLIER'S WEEKLY, 521 West 13th St., New York City.

The No. 4 YOST WRITING MACHINE



The distinctive features of the Yost Machine, permanent alignment, direct inking, beautiful work, strength, simplicity, and durability are shown in perfection in the No. 4 Model.

Yost Writing Machine Co.
NEW YORK CITY. LONDON, ENG.

The Typewriter Exchange

1 1/2 Barclay St., NEW YORK
124 La Salle St., CHICAGO
38 Bromfield St., BOSTON
817 Wyandotte St., KANSAS CITY, MO.
209 North 9th St., ST. LOUIS, MO.
432 Diamond St., PITTSBURGH, PA.
3 West Baltimore St., BALTIMORE, MD.
536 California St., SAN FRANCISCO, CAL.
We will save you from 10 to 50% on Typewriters of all makes. Send for Catalogue.

Mechanical Movements, Powers, Devices, and Appliances.

By GARDNER D. HISCOX, M. E., Author of "Gas, Gasoline, and Oil Engines."

A Dictionary of Mechanical Movements, Powers, Devices, and Appliances, embracing an illustrated description of the greatest variety of mechanical movements and devices in any language. A new work on illustrated mechanics, mechanical movements, devices and appliances, covering nearly the whole range of the practical and inventive field, for the use of Mechanicians, Mechanics, Inventors, Engineers, Draughtsmen, Students, and all others interested in any way in the devising and operation of mechanical works of any kind.

Large 8vo. 400 Pages. 1649 Illustrations. Price \$3.

A full table of contents will be sent free upon application to

MUNN & CO., Publishers,
361 Broadway, New York.

Velocipede handle bar, C. J. Shields.....	645.977
Velocipede pedal driving gear, C. I. Faulkner.....	645.947
Vending machine, G. F. Brown.....	646.260
Vener coil and nailing machine, G. A. Gage.....	645.939
Ventilator, See Roof ventilator.....	
Vessel hulls, machine for cleaning, Cook & Stern.....	646.357
Vessel indicator, A. L. McCormick.....	646.307
Vessel, navigable, H. L. J. C. Turc.....	646.331
Vessels auxiliary motor for, R. T. Power.....	646.314
Viscose, manufacture of, E. Thomas et al.....	646.044
Water gauge, J. A. & S. Fletcher.....	646.022
Water, purifying, J. MacDougal.....	646.357
Water purifying apparatus, C. L. Kennicott.....	646.108
Wave motor, J. C. Walker.....	646.199
Wheel, See Current wheel, Trolley wheel, Vehicle wheel.....	
White, G. H. Crosby.....	646.165
Wheels, machine for making metal, E. Einfeldt.....	646.289
Wheels, making metal, F. Einfeldt.....	646.270
Winding machine yarn clearer, H. M. Girdwood.....	646.023
Window screen, H. E. Gallaher.....	646.120
Wire fabric, J. W. Sheppard.....	646.131
Woven fabric, M. Koeck.....	646.123
Wrapper or envelop, J. Gearing.....	646.000
Wrapping machine, Forbes & Grover.....	646.208
Wrench, P. R. Coleman.....	646.263
Wrench, M. D. Miller.....	646.077
Wrench, J. T. Viles.....	646.086
Yarn controller, T. Ashworth.....	645.931

DESIGNS.

Badge, W. E. McCarty.....	32.378
Bath tub, W. Scott.....	32.411
Bed end frame, E. J. Barcalo.....	32.410
Bed thinner, Venhuizen.....	32.403
Belt, R. F. Barry.....	32.419
Broom holder, F. J. Wallace.....	32.388
Carpet button, stair, D. Walker.....	32.394
Coat-pad, G. Goldman.....	32.417
Corset, I. W. Birdseye.....	32.418
Dolly, J. W. Catty.....	32.414
Filament for incandescent electric lights, S. B. Hesselman.....	32.396
Fork, R. J. MacDowell.....	32.380
Hammer head, D. C. Whitford.....	32.402
Hook, garment supporting, Taylor & Hammond.....	32.383
Hook, whiffetree, S. Larson.....	32.405
Lamp, bicycle, W. J. Frost.....	32.389
Leather fabric, J. Nieder.....	32.415
Level, G. F. Conner.....	32.390
Lock case, H. G. Voight.....	32.392
Medallion, W. W. Coe.....	32.379
Pan, cake, M. J. Rutherford.....	32.386
Photographic cabinet, B. E. Underwood.....	32.412
Post base, J. G. Gladney.....	32.404
Pulley case, H. A. Frost.....	32.394
Railway rail, S. Hazard.....	32.406
Razors, etc., handle for, W. M. Taussig.....	32.382
Rein holder, J. E. Kennedy.....	32.385
Scale frame standard, J. W. Cuimer.....	32.393
Scoop, W. W. Baird.....	32.387
Seal body, self locking, E. Tyden.....	32.391
Show case, display, J. G. Hutchinson.....	32.413
Siphons, etc., shield or guard for, J. Cederstrom.....	32.397
Soap dish, J. F. Stepp.....	32.385
Sole fabric, shoe, J. E. Kennedy.....	32.416
Spoon or fork handle, J. H. Leech.....	32.381
Sprayer body, D. B. Smith.....	32.386
Spraying apparatus atomizing tip, W. H. Rice.....	32.399
Stove, heating, J. K. McLaughlin.....	32.409
Threshing machine cylinder tooth, G. F. Conner.....	32.400
Tricycle frame, W. W. Catty.....	32.408
Vehicle motor casing, F. A. Phelps.....	32.408
Wrench, G. F. Conner.....	32.401

TRADE MARKS.

Bakery product, certain named, F. Rayner.....	34.385
Baking powder, Buyit & Tritt Company.....	34.383
Beer, lager, Pabst Brewing Company.....	34.379
Brushes, John L. Whiting & Son Company.....	34.388
Chemical and pharmaceutical preparations, Heine & Company.....	34.390
Cigarettes, cigars and smoking and chewing tobacco, Union Tobacco Company of America.....	34.376
Cotton fabrics, J. Farnum & Company.....	34.388
Cotton linings, J. W. Goddard & Sons.....	34.357
Curios, certain named, F. H. Stearns.....	34.387
Embalming fluid, B. Wheatley, Jr.....	34.368
Engine, double cylinder piston movement, Asolene, Pennsylvania Iron Works Company.....	34.395
Flour, wheat, Herklotz, Corn & Company.....	34.384
Food products, certain named, Stobie Cereal Mills.....	34.382
Gas mantles, incandescent, Consolidated Incandescent Light Company.....	34.390
Gloves, certain named, J. Adler & Company.....	34.355
Hammers, A. R. Robertson.....	34.394
Horse blankets, Beckman Company.....	34.359
Hosiery, knit underwear, and gloves, Ferguson-McKinney Dry Goods Company.....	34.356
Ice cream in block form, L. Davis.....	34.381
Insecticides, W. H. Bowker.....	34.369
Matches, American Match Machine Company.....	34.374
Medicaments, certain named, H. A. Blair.....	34.365
Medicine, certain named, Winkelmann & Brown Drug Company.....	34.364
Milinery headgear, J. M. Remy.....	34.382
Oil of tobacco for cancer cure, Krenzel & Williby.....	34.387
Packing house products, certain, Swift & Company.....	34.386
Perfume, L. R. Harrison & Company.....	34.375
Pills, iron tonic, Kamps & Sacksteder.....	34.366
Remedy for certain named diseases, E. G. Simcox.....	34.362
Remedy for certain named diseases, liquid, U. V. Remedy Company.....	34.363
Shade rollers, Stewart Hartshorn Company.....	34.393
Teas and coffee, Griggs, Cooper & Company.....	34.380
Turpentine, T. Shea.....	34.373
Whisky, E. Martin & Company.....	34.378
Wire goods and articles made of wire, Wright & Colton Wire Cloth Company.....	34.392

LABELS.

"Acetol," for a medicine, J. B. Smith.....	7.446
"Austro Silk," for dry goods, W. Simpson Sons & Company.....	7.430
"Bernheim's Gold Coloring Solution," for a coloring solution, E. C. Bernheim.....	7.441
"Britania Old Tom London Gin," for gin, Wittmann Brothers.....	7.437
"Dr. Flora's Remedy," for a medicine, G. C. Cornelius.....	7.445
"Eat Sun (Rise) Rolled Oats for Breakfast," for rolled oats, S. F. Butts.....	7.438
"Highland P. Scotch Whisky," for whisky, Wittmann Brothers.....	7.436
"Hunt's Perfect Baking Powder," for baking powder, P. B. Hunt.....	7.440
"Illinois Club," for whisky, Burke Brothers Company.....	7.433
"J. B. Baker's Wormwood Liniment," for a liniment, J. B. Baker.....	7.443
"Jefferson Rye," for whisky, K. Devine.....	7.434
"Laughlin's Infant Cordial, the Child's Cure When Teething," for a cordial, J. G. McLain.....	7.447
"Malt-Oats Breakfast Food," for an oat cereal, Malted Cereals Company.....	7.439
"Mundy's Specific Compound," for a medicine, Bonsall, Atwell & Company.....	7.444
"O. P. S. Scotch Whisky," for whisky, Wittmann Brothers.....	7.435
"Shamrock Shampoo," for a shampoo, Armagost & Anderson.....	7.442
"The Clothing That Makes Rochester Famous," for ready made clothing, Solomon Brothers & Lempert.....	7.431
"The Hub," for cigars, S. Paley.....	7.432

PRINTS.

"Argenteuil Asparagus," for asparagus, A. Jouan.....	215
"Canfield," for dress shirts, J. Canfield.....	213
"Triumphal Arch," for milinery goods, James G. Johnson & Company.....	214

A printed copy of the specification and drawing of any patent in the foregoing list, or any patent in print issued since 1865, will be furnished from this office for 10 cents. In ordering please state the name and number of the patent desired, and remit to Munn & Co., 361 Broadway, New York. Special rates will be given where a large number of copies are desired at one time.

Canadian patents may now be obtained by the inventors for any of the inventions named in the foregoing list, provided they are simple, at a cost of \$40 each. If complicated the cost will be a little more. For full instructions address Munn & Co., 361 Broadway, New York. Other foreign patents may also be obtained.



will do better work for a longer time, with less exertion, than any other writing machine. Thousands of satisfied users pronounce it....

Perfectly Simple and Simply Perfect.

Let it lighten your business burden.

ILLUSTRATED CATALOGUE FREE.

The Smith Premier is especially adapted to the "Touch System" of Typewriting.

The Smith Premier Typewriter Co. Syracuse, N. Y., U. S. A.



SECOND HAND ENGINE For sale one Prof. Sweet straight line engine, 11x16 cylinder. In excellent condition; has had best of care. A bargain. Send for particulars. W. F. & J. N. BARNES CO., Rockford, Ill.

PATENT for sale or on royalty. Apparatus for extinguishing gas at fixed periods. Suitable for dwellings, stores, factories, sleeping apartments, etc. U. S., English and French patents for sale. Address P. BARNIKEL, inventor, 705 DeKalb Ave., Brooklyn, N. Y.

AN ENGINEER

who can give security, and who represents German locomotive works, desires to communicate with competent locomotive builders (that can turn out work at short notice) for the sale of Tender Locomotives in Germany. Competent firms are requested to send particulars, as well as sketches or catalogues of their Locomotives, to C. C. 7533, care of RUDOLPH MOSSE, Berlin, S. W., Germany.

50 YEARS' EXPERIENCE



TRADE MARKS
DESIGNS
COPYRIGHTS & C.

Anyone sending a sketch and description may quickly ascertain our opinion free whether an invention is probably patentable. Communications strictly confidential. Handbook on Patents sent free. Oldest agency for securing patents. Patents taken through Munn & Co. receive special notice, without charge, in the

Scientific American.

A handsomely illustrated weekly. Largest circulation of any scientific journal. Terms, \$3 a year; four months, \$1. Sold by all newsdealers.

MUNN & Co. 361 Broadway, New York
Branch Office, 625 F St., Washington, D. C.



The Jewett

hasn't been tacked-on-to. It's new. It's this year's model. The machine we sold eight years ago is giving good service to-day. It lasts. It STANDS HARD SERVICE

Our 1900 Jewett lasts because constructed along the same lines, but it meets to-day's requirements better. It is being built to supply to-day's demands. Write for booklet, which illustrates and explains everything.

Jewett Typewriter Co., 616 Locust St., Des Moines, Ia



"Best in the World"

CALCIUM CARBIDE EXPORT CO.,
35 NASSAU STREET, NEW YORK.
(A B C Code.) Cable Address: BRYAXE, NEW YORK.

FINE FISH TACKLE

handmade and Bristol Steel Rods, Cosmic Lines, Reels, Flies, etc., etc., selected for retail trade. Rushton Canoes and Boats. Morris Canoes. THE H. & D. FOLSOM ARMS CO., 316 Broadway, N. Y.

Ghost of the Glacier

And Other Tales, including Making a Revolution, Squeehanna Trail, Sculpture of the Elfs. Once a Pillar of the World, Feathers of Fashion, and others. A delightful volume, beautifully illustrated. Ready for distribution about May 1. Send 10 cents to T. W. Lee, General Passenger Agent, Lackawanna Railroad, 26 Exchange Place, New York City. Edition Limited.

Brass Band
Instruments, Drums, Uniforms, & Supp. Inc. Write for catalog, 445 illustrations, FREE; it gives information for musicians and new bands. LYON & HEALY, 88 Adams St., CHICAGO.

IT COST US \$4,000 Costs 15c
You
We have spent \$4,000 on our new book, "How to Make Money with Poultry and Incubators." It tells all. Leading poultry men have written special articles for it. 192 pages, 8x11 in. Illustrated. It's as good as gold. Send 15c for it. It's the best. Out hatch any other machine. 16 page circular free. Send 15c in stamps for \$4.00 book No. 184. Address nearest office. CYPHERS INCUBATOR CO. Boston, Mass. Wayland, N. Y. Chicago, Ill.

YOU MAKE BIG MONEY Entertaining the Public with Motion Pictures, the new Grapho-Ampliphone Talking and Musical Combination and Panoramic Stereoptics in Views \$50 to \$500 per week without previous experience. Only a little money needed to start with, and any man can operate our outfits successfully. Write for catalog Entertainment Supply Co., 56 & 58 Fifth Av., Chicago.

D'AMOUR & LITLEDALE MACHINE CO.
130 WORTH ST. NEW YORK.
Make Models of Any Machine to Order.

THE BICYCLE: ITS INFLUENCE IN Health and Disease.—By G. M. Hammond, M.D. A valuable and interesting paper in which the subject is exhaustively treated from the following standpoints: 1. The use of the cycle by persons in health. 2. The use of the cycle by persons diseased. Contained in SCIENTIFIC AMERICAN SUPPLEMENT, No. 1002. Price 10 cents. To be had at this office and from all newsdealers.

D. L. HOLDEN
1336 BEACH ST. PHILADELPHIA PA.
SOLE MANUFACTURER
REGALED ICE MACHINES
SEE FIRST PAGE SCIENTIFIC AMERICAN SEPT. 2, 1899.

BOYS PAPER: FREE if you will send names of boy friends over 12 years of age we will send you the Star for 3 months free. Greatest boys' paper published. Address with stamp, THE STAR, Dept. 84, OAK PARK, ILLS.

PLEASE PAYS EXPENSES and per month. Steady position; self-seller; no experience needed. Send 2c for contract. PEASE MFG. CO., Cincinnati, O., Dept. 10.

\$3 a Day Sure
Send us your address and we will show you how to make \$3 a day absolutely sure; we furnish the work and teach you free; you work in the locality where you live. Send us your address and we will explain the business fully; remember we guarantee a clear profit of \$3 for every day's work, absolutely sure, write at once. ROYAL MANUFACTURING CO., Box 11, DETROIT, MICH.

WHY NOT MAKE RUBBER STAMPS ??

DO YOU WANT TO GO INTO BUSINESS for YOURSELF. or ADD a GOOD LINE to Your Present Business ?

With a "New York" Rubber Stamp Vulcanizer and Manufacturing Outfit, requiring but little money to start, you can have pleasant and profitable work that can be made to pay well in a permanent location, or traveling. It will pay any Stationer or Printer well to put in one of our Outfits. These machines, by their PATENTED LEVER ACTION, produce the finest class of Rubber Stamps. They received HIGHEST AWARD—MEDAL AND DIPLOMA—at WORLD'S FAIR, CHICAGO, and are used by the leading stamp manufacturers of the United States. With each machine is sent our Pocket Guide, "How to Make Rubber Stamps for Profit," which makes every detail so plain that any person can at once turn out First-Class Stamps. This little book is also sold separately at \$1.00 per copy, which amount is refunded to purchasers of our Vulcanizers.

Write at once, to-day, for Catalogue "C."

We manufacture Rubber Stamps, Ink Pads, Stencils, Numbering Machines, etc. **BARTON MFG CO., 338 Broadway, New York.**

Inventors and Owners of Patents!

We have offices, selling agencies, and correspondents at every principal distributing point throughout the world; a large force of traveling men in the United States, in Great Britain, and Continental Europe; and over 300 corresponding buyers in foreign lands. We will accept sole selling agencies, or will buy patents for cash or royalty, on valuable machinery, hardware specialties, tools, etc. Correspondence solicited.

AMERICAN MACHINERY AND TRADING COMPANY.
 MAIN OFFICE—Bowling Green Building, New York City.
 BRANCHES—Chicago, Pittsburg, Philadelphia, Boston, Atlanta, St. Louis, San Francisco, Montreal, London, Paris, Berlin, St. Petersburg, Sydney.

THOROUGH INSPECTIONS
 AND INSURANCE AGAINST LOSS OR DAMAGE TO PROPERTY AND LOSS OF LIFE INJURY TO PERSONS CAUSED BY STEAM-BOILER-EXPLOSIONS

HARTFORD STEAM BOILER INSPECTION AND INSURANCE CO. CONN.

J. M. ALLEN, PRESIDENT W. B. FRANKLIN, VICE PRESIDENT
 J. B. PIERCE, SECRETARY T. B. ALLEN, 2ND VICE PRESIDENT
 L. B. BRAINERD, ASST. TREAS. L. F. MIDDLEBROOK, ASST. SECY.

FASHIONABLE LOCOMOTION

The fashion now is not horseback riding for exercise. Nor driving a tandem through the park. The real "smart" set are better pleased with a

WINTON MOTOR CARRIAGE

Price \$1,200. No Agents.

because it is swift, safe, silent, sure and satisfactory. It is a clean, quick and economical method of taking exercise. You regulate the speed yourself. Hydro-Carbon system. Catalogue free.

THE WINTON MOTOR CARRIAGE CO., Cleveland, Ohio.
 Eastern Department, 120 Broadway, New York City.

"Light of Asia" Lamp

The Smallest Portable Electric Light.

Unlike all other portable lights, the batteries of the "Light of Asia" Lamp do not deteriorate unless used. For a good light for short intervals, this lamp is pre-eminent. The "Light of Asia" Lamp is made with a view to beauty, and is mounted in an aluminum shell covered with fine leather.

Weight, 5½ ounces.
 ¾ inch diameter.
 8 inches long.

PRICE, \$3.00, POSTPAID.
 Every one Guaranteed.

Electric Contract Co.,
 61 Elm Street,
 NEW YORK.

P. T. AUSTEN, Ph.D., F. J. MAYWALD, L. S. MOTT,
 President. Vice-Pres. Sec. and Treas.

The Austen Chemical Research Co.

Testing, Perfecting, Introducing and Disposing of Processes, Products, Patents, Novelities and Formulas. Correspondence is solicited with Chemists having Inventions, Improved Processes or Novelities to Dispose of. Explanatory Circular on Application.

52 BEAVER STREET, NEW YORK.

HELMET OIL LUBRICATES ANYTHING
 IF YOU HAVE A HOT BOX TRY IT. CH. BEESLY & CO. CHICAGO, ILL. U.S.A.

HAVE THE LATEST IMPROVEMENTS.
 No machine shop can be thoroughly up-to-date unless it has the most modern perfected tools. For instance, the

ASHLEY PATENT NIPPLE HOLDERS
 hold nipples for cutting either right or left hand threads. They hold the sleeve from turning and take the strain off both the sleeve and shank thread. Made of best quality cast steel, carefully fitted. Long or short nipples cut with equal facility. The Ashley Holders are of light weight and compact form.

WALWORTH MANUFACTURING CO.
 128 TO 136 FEDERAL ST., BOSTON, MASS.

HAVE YOUR CYCLE FITTED WITH MORROW HUB BRAKE
 WITH THIS YOU RIDE 50 MILES BUT PEDAL ONLY 35.

OVER 25,000 IN USE.
 EASILY PUT ON. HAS PROVED PERFECT AND RELIABLE. FULLY GUARANTEED.

Coasting becomes so safe and easy you do it every chance you get. Your feet on the pedals gives perfect control of the wheel. Ladies' skirts keep down when coasting. You can adjust it to any make of cycle.

Our Acetylene Bicycle Lamp is superior in construction to any made.

Illustrated pamphlet giving detailed information regarding Brake and Lamp, sent on application.

ECLIPSE BICYCLE CO.
 Box X, ELMIRA, N. Y.

FOR MEN OF BRAINS
Cortez CIGARS
-MADE AT KEY-WEST-

These Cigars are manufactured under the most favorable climatic conditions and from the mildest blends of Havana tobacco. If we had to pay the imported cigar tax our brands would cost double the money. Send for Booklet and Particulars.

CORTEZ CIGAR CO., KEY WEST.

"Costs Nothing When Not Working."

You can insure good and quick work in your shop if you are supplied with one of our

"G E" SMALL MOTORS.

Run from lighting circuit. 110 volts. Expense stops when they stop. Send for Circular S. A.

GENERAL ELECTRIC CO., Main Office, Schenectady, N. Y.

CHARTER Gasoline Engine

USED ANY PLACE BY ANYONE FOR ANY PURPOSE

Stationaries, Portables, Engines and Pumps.

State your Power Needs.

CHARTER GAS ENGINE CO., Box 148, STERLING, ILL.

Scales

All varieties at lowest prices. Best Railroad Track and Wagon or Stock Scales made. Also 1000 useful articles, including Saws, Sewing Machines, Bicycles, Tools, etc. Save Money. Lists Free. CHICAGO SCALE CO., Chicago, Ill.

BARNES' UPRIGHT DRILLS

Complete line, ranging from Light Friction Disk Drill to 42" Back Geared Self-Feed. Send for New Catalogue.

W. F. & JOHN BARNES CO.
 1999 Ruby Street, ROCKFORD, ILL.

CAPE NOME, CAPE YORK, ST. MICHAEL, DAWSON
AND ALL POINTS ON THE YUKON RIVER DIRECT.

Operating ITS OWN Fleet of First-Class Ocean Steamships
ST. PAUL, PORTLAND, BERTHA, RAINIER, DORA and others.

Full Line of River Steamers on the Yukon.

Under contract to deliver United States Mails throughout the Territory.
 First Departure, APRIL 30th, and Fortnightly thereafter.

For new Folders, Maps and further particulars as to Freight and Passage, write to
ALASKA COMMERCIAL COMPANY,
 310 SANSOME STREET, SAN FRANCISCO, CAL., for all particulars.

"Perfect" Scrap Book

A most useful article for the home and office. No pasting. You can always read both sides of your clipping. They rest in a pocket. Sample, postpaid, 50 cents. The Perfect Scrap Book Co., Dept. F., 150 Nassau Street, New York.

Models and Experimental Work

Inventions Developed. Special Machinery.
 E. V. BAILLARD, 106 Liberty Street, New York.

EVOLUTION OF THE AMERICAN Locomotive.—By Herbert T. Walker. A valuable series by a member of the National Railway Museum Committee. The locomotive from 1825 to date is described and illustrated by careful drawings, great attention being given to historical accuracy. 21 illustrations. SCIENTIFIC AMERICAN SUPPLEMENTS 1112, 1113, 1114. Price 10 cents each. For sale by Munn & Co. and all newsdealers.

SAVAGE Hammerless Magazine Rifle
SMOKELESS
 .303 CAL.

The most reliable and safest rifle ever manufactured. Shoots six different cartridges adapted for large and small game.

Write for Descriptive Catalogue A.

SAVAGE ARMS CO.
 UTICA, NEW YORK, U. S. A.

Point Blank Range for Hunting.
 The Only Hammerless Repeating Rifle.

HIGH GRADE FOOT POWER LATHES
 W. P. DAVIS, ROCHESTER, N. Y.

ASBESTOS FIRE-FELT COVERINGS
 PURE ASBESTOS. ABSOLUTELY FIRE PROOF. REPLETE WITH AIR CELLS. PERFECT NON-CONDUCTORS. STRONG, LIGHT, FLEXIBLE. EASILY APPLIED. MADE IN SECTIONS THREE FEET LONG. FIT STANDARD PIPE ½ INCH TO 16 INCHES.

H. W. JOHN'S MFG CO.
 NEW YORK-CHICAGO-PHILADELPHIA-BOSTON-MADE IN U.S.A.
 ASBESTOS MATERIALS. LIQUID PAINTS & STAINS. ROOFING MATERIALS. ELECTRICAL MATERIALS.

"PEGAMOID" ALUMINUM PAINT.

Latest application of Aluminum. Looks like Frosted Silver. Washable. Untarnishable. Water, Oil and Weatherproof. Durable. Easily Applied. Bicycles, Yachts, Radiators, Pipes, Metal Work, Machinery, Dynamos, Motors, Apparatus, Aero Lamps, Sockets, Brackets, Cars, Stations, General Decoration, etc. Sample bottle, by mail, for 25 cents.

THE AMERICAN PEGAMOID CO., 339 B'way, New York.

WILLIAMS' SHAVING STICK
 THE ACME OF LUXURY

THE PINNACLE OF PERFECTION

SOLD EVERYWHERE - BY MAIL 25c. IF YOUR DEALER DOES NOT SUPPLY YOU.

THE J. B. WILLIAMS CO.
 GLASTONBURY CONN.
 LONDON-PARIS-DRESDEN-SYDNEY.

Acetylene Burners.
 Samples, ¼ to 1 foot, 25c. each.
 A new burner for STEREOPTICONS.
 Highest C.P. possible.
 State Line Talc Co., Chattanooga, Tenn.

"The Reeves" Variable Speed Countershaft

Powerful, Responsive, Durable and Efficient.

for securing any speed without change of belt or loss of time. Especially adapted for all kinds of Ironworking Machinery, Iron Lathes, Planers, Boring Mills, Shapers, etc.; Cement Machinery, Experimental Machinery—in fact all kinds of machinery requiring a change of speed. With it a large increase and a better grade of work can be produced.

Send for handsomely illustrated catalogue "S. A." free.

REEVES PULLEY CO.
 COLUMBUS, IND., U. S. A.

BICYCLE TIRE REPAIRING.—THE Mending of Single Tube Tires.—A practical article illustrating the method of inserting patches and plugs with pliers and pluggers, together with rubber band plugging and the use of puncture bands. 9 illustrations. Contained in SUPPLEMENT 1102. Price 10 cents. For sale by Munn & Co. and all newsdealers.

Learn to Write "Ads"

We will teach you this business practically and thoroughly BY MAIL. Advertisement writers earn large salaries. The demand is large—the prospects big. Instruction is personal and private. Send for full particulars.

Page-Davis Correspondence School of Adv., 515 Medinah Temple, Chicago.

Burglar Alarm.

The best is a

Smith & Wesson

Revolver. Catalogue for a stamp.
 SMITH & WESSON, 14 Stockbridge Street, Springfield, Mass.
 159 New Montgomery St., San Francisco, Cal.

JESSOP'S STEEL THE VERY BEST FOR TOOLS, SAWS, ETC.
 WM. JESSOP & SONS, 121 JOHN ST., NEW YORK

PRINTING INKS
 The SCIENTIFIC AMERICAN is printed with CHAS. ENEU JOHNSON & CO.'S INK, Tenth and Lombard Sts., Philadelphia, and 47 Rose St., opp. Duane, New York