

SCIENTIFIC AMERICAN

[Entered at the Post Office of New York, N. Y., as Second Class Matter. Copyright, 1888, by Munn & Co.]

A WEEKLY JOURNAL OF PRACTICAL INFORMATION, ART, SCIENCE, MECHANICS, CHEMISTRY, AND MANUFACTURES.

Vol. LXXVIII.—No. 10.
ESTABLISHED 1845.

NEW YORK, MARCH 5, 1898.

[\$3.00 A YEAR.
WEEKLY.]

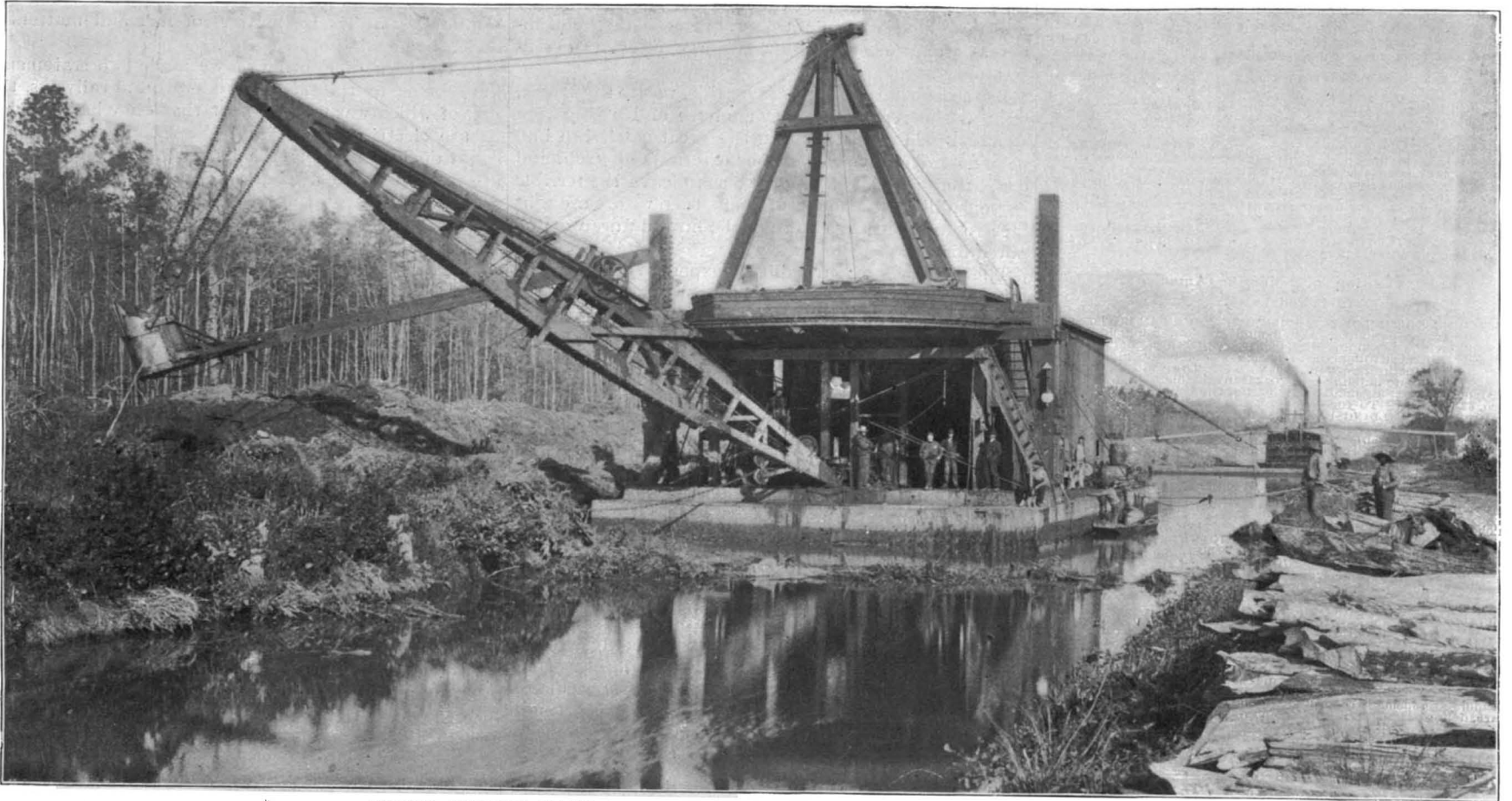

DIPPER DREDGE MAKING SURFACE CUT, HYDRAULIC DREDGE FOLLOWING.

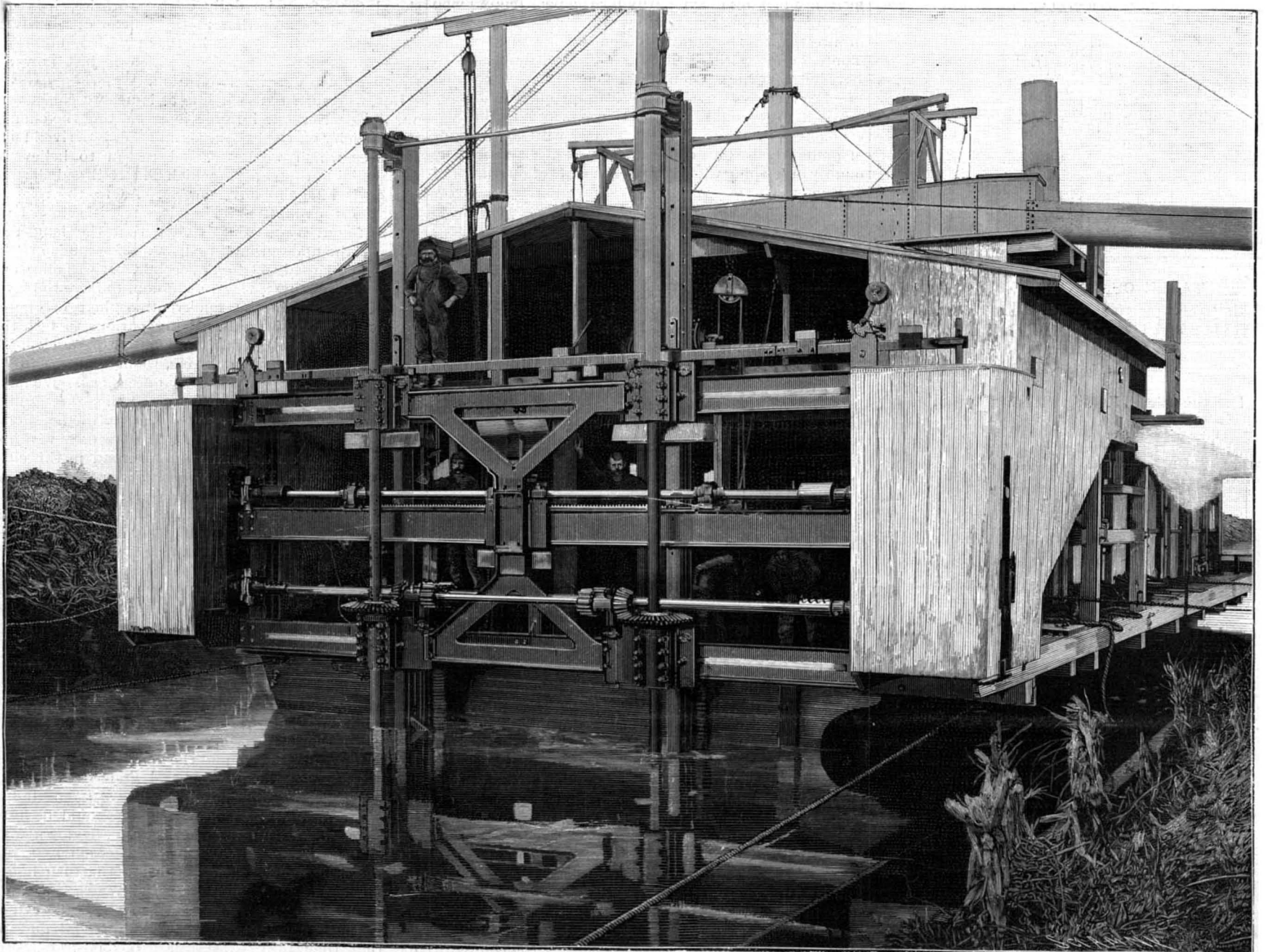

FRONT VIEW OF HYDRAULIC DREDGE—MAXIMUM CAPACITY, 2,500 YARDS PER DAY.
THE RECONSTRUCTION OF THE DISMAL SWAMP CANAL.—[See page 153.]

Scientific American.

ESTABLISHED 1845

MUNN & CO., - - - EDITORS AND PROPRIETORS.

PUBLISHED WEEKLY AT

No. 361 BROADWAY, - - NEW YORK.

TERMS FOR THE SCIENTIFIC AMERICAN

(Established 1845.)

One copy, one year, for the U. S., Canada or Mexico.....\$3.00
One copy, six months, for the U. S., Canada or Mexico..... 1.50
One copy, one year, to any foreign country, postage prepaid, 20 lbs. 3d. 4.00

Remit by postal or express money order, or by bank draft or check.

MUNN & CO., 361 Broadway, corner Franklin Street, New York.

The Scientific American Supplement

(Established 1876)

Is a distinct paper from the SCIENTIFIC AMERICAN. THE SUPPLEMENT is issued weekly. Every number contains 16 octavo pages, uniform in size with SCIENTIFIC AMERICAN. Terms of subscription for SUPPLEMENT, \$5.00 a year for the U. S., Canada or Mexico, \$6.00 a year, or \$1 1/2 3d. to foreign countries belonging to the Postal Union. Single copies 10 cents.

Building Edition of Scientific American.

(Established 1885.)

THE BUILDING EDITION OF THE SCIENTIFIC AMERICAN is a large and splendidly illustrated periodical, issued monthly, containing floor plans and perspective views pertaining to modern architecture. Each number is illustrated with beautiful plates, showing desirable dwellings, public buildings and architectural work in great variety. To architects, builders, and all who contemplate building this work is invaluable.

Export Edition of the Scientific American

(Established 1878)

with which is incorporated "LA AMERICA CIENTIFICA E INDUSTRIAL," or Spanish edition of the SCIENTIFIC AMERICAN, published monthly, uniform in size and typography with the SCIENTIFIC AMERICAN. Every number contains about 10 pages, profusely illustrated. It is the finest scientific industrial export paper published. It circulates throughout Cuba, the West Indies, Mexico, Central and South America, Spain and Spanish possessions—wherever the Spanish language is spoken.

The safest way to remit is by postal order, express money order, draft or bank check. Make all remittances payable to order of MUNN & CO. Readers are specially requested to notify the publishers in case of any failure, delay, or irregularity in receipt of papers.

NEW YORK, SATURDAY, MARCH 5, 1898.

Contents.

(Illustrated articles are marked with an asterisk.)

Acetylene gas generator, an automatic* 148
Acetylene gas on a railway train 151
Balloons, measuring heights reached by* 152
Bird fascinated by a snake 151
Canal profile, Dismal Swamp* 154
Cargo carriers, two great* 147
Cockerel, a horned* 155
Color, self-luminant* 151
Copper engravings, bleaching 151
Dismal Swamp canal, the* 145
Dogs, ancient varieties 151
Dredging apparatus, a great* 145
Electricity, producing reliefs by "Fire battery," Ready's* 148
Fish's eyes, movement of 154
Heavens, the, in March 147
Inventions recently patented 153
Japan, industries of 151
Jewsharp, a primitive Maya 150
Lake Drummond, Va.* 153
Lake Fusino, draining of 150
Lobsters from the Pacific 150
Locks, Dismal Swamp canal* 153
"Maine" inquiry 146
Mining, submarine* 149
Nuts, a device for fastening* 155
Opium industry in America 147
Ormolu or shell gold 151
Patents granted, weekly record 156
Petrified forest protection 151
Photographic apparatus, Cailliet's automatic* 152
Railroad cars, side or end doors 146
Railroad to the Yukon 146
Railway train lighted by acetylene 151
Rug industry, the Japanese 148
Science notes 151
Snake charming 150
Steam turbines, reversing in 150
Sugar-eating nations 150
Tire bolt wrench, Wiley's* 148
Torpedo warfare, modern* 149
Woodenware, varnishing 151

TABLE OF CONTENTS OF Scientific American Supplement

No. 1157.

For the Week Ending March 5, 1898.

Price 10 cents. For sale by all newsdealers.

I. ARCHÆOLOGY.—Requirements of Palestine Explorer..... 18489
II. BIOGRAPHY.—Emperor William II. of Germany.—An interesting biographical account of the German Emperor, with his latest portrait.—1 illustration..... 18496
III. CIVIL ENGINEERING.—Heat in Great Tunnels..... 18492
IV. ECONOMICS.—Causes of Poverty..... 18490
V. ELECTRICITY.—Liquid Rheostats.—By H. S. WEBB..... 18498
The Neutral Use of Cables..... 18489
VI. ETHNOLOGY.—The Influence of Scenery upon the Character of Man..... 18488
VII. FORESTRY.—Apparatus for Obtaining the Cubature of Trees.—3 illustrations..... 18493
VIII. GYMNASTICS.—A Novel Way of Riding a Bicycle.—1 illustration..... 18489
IX. HYDROGRAPHY.—Influence of Ocean Currents on Climate..... 18490
X. LANDSCAPE GARDENING.—Park Making..... 18490
XI. MARINE ENGINEERING.—The Newfoundland and Nova Scotia Passenger Steamer "Bruce."—1 illustration..... 18492
XII. MECHANICAL ENGINEERING.—Machine Moulding without Stripping Plates.—By E. H. MUMFORD.—A full description of an ingenious moulding machine.—7 illustrations..... 18494
XIII. MEDICINE.—The Progress of Medical Education in the United States..... 18499
Deaths under Anesthetics..... 18499
XIV. MISCELLANEOUS: Engineering Notes..... 18491
Miscellaneous Notes..... 18491
Selected Formulae..... 18491
XV. NATURAL HISTORY.—Tapirs in the Zoological Garden at Breslau.—1 illustration..... 18488
XVI. STEAM ENGINEERING.—An English Steam Fire Engine.—1 illustration..... 18493
XVII. TRAVEL AND EXPLORATION.—My Recent Journey from the Nile to Suakim.—By FREDERIC VILLIERS.—The advance to Khartoum.—An important account of the recent travels of the celebrated war correspondent..... 18496
XVIII. TECHNOLOGY.—Artificial India Rubber.—This article describes some important experiments which have been made in which India rubber substitutes have been produced from oil of turpentine..... 18495
Deep and Frosted Etching on Glass..... 18496
The Koppel Electric Locomotives.—This article describes a system of electric trolley traction for narrow gauge railroads.—7 illustrations..... 18497
Slate and its Applications.—This article details some of the various uses to which slate is put in the arts, with a view of the store vats for breweries..... 18496
Birthplace of the Oilcloth Industry..... 18496

THE "MAINE" INQUIRY.

The self-restraint and careful deliberation with which Congress is proceeding in the "Maine" investigation have been received by the public with feelings of great relief and entire satisfaction. There have been one or two hasty and illtimed outbursts, accompanied by the usual clamoring after "facts" and "correspondence," but such demonstrations have been quickly suppressed and the perpetrators have been sharply rebuked both within and without the halls of Congress.

Looked at in its most unfavorable, not to say tragic, light, if the report of the Committee of Investigation should disclose the fact that the great battleship had been destroyed by some agency external to herself, and could that agency be traced so as to leave the terrible responsibility at the doors of Spain, then we are brought face to face with the stern facts, how far are we prepared for war?

The warnings of our military experts regarding the unpreparedness of our fortifications are fresh in our ears. Have we not recently been told that we have artillery without artillerists, guns without mounts and emplacements without guns? These things, thanks to a prevailing activity in our arsenals and a belated but welcome liberality in Congress, are being rectified—but the rectification takes time.

Every reason, moral and practical, demands that there shall be no haste, and that the investigation shall be patient, detailed and absolutely impartial. What the country demands is that in due time and in its proper season the truth shall be reached.

Thrice is he armed that hath his quarrel just, And he but naked, though locked up in steel, Whose conscience with injustice is corrupted.

If such a calamity should arise that we should be compelled to take up arms, it must be only after we have satisfied ourselves and the world at large beyond any question of doubt that the noble vessel was sunk by a deliberate act or with the connivance or through the criminal negligence of the people with whom we fight.

It is both insulting and unjust to suggest that those who are exhibiting self-restraint and deliberate judgment are lacking in sympathy for the poor fellows who have perished or that they do not feel keenly the loss of prestige in the sinking of one of our finest ships. The calmness with which this awful disaster has been received is an indication of the depth of feeling which has been stirred in the American people. Had they felt less, they would have said more. As it is, the government is proceeding in the matter with an absence of panic which is an evidence of strength and is thoroughly in keeping with the best elements of our national character.

RAILROAD TO THE YUKON.

A contract has been let for the opening of a rail and river route to the Yukon, and if the pledges of the contractors can be fulfilled, one hundred and fifty miles of railroad will be in operation by September 1 of this year. The proposed route is as follows: By ocean steamer to the mouth of the Stikeen River, near Fort Wrangel, Alaska; thence by river boats up the Stikeen River to Telegraph Creek; thence by railroad to the head of Teslin Lake—a distance of 150 miles. From this point a line of steamboats will run up the lake to the point where it discharges itself by the Hootalingua River into the Yukon.

The survey carried out by the Canadian Department of Railways showed that the Stikeen River is navigable for 150 miles from the sea, and it was estimated that a powerful steamer could make the passage to Telegraph Creek in two days. The cost of a steam railroad from this point to Teslin Lake is estimated at \$4,000,000. The government engineer also sends in an estimate for an electric road 165 miles in length, which he states could be built for \$2,850,000. Teslin Lake, which is 61 miles long, was found to be open for navigation on May 18, and froze over again on October 27.

The construction of 150 miles of railroad involving heavy excavation in such a remote country and within such a limited period seems to be a formidable undertaking, especially when the rigorous nature of the climate is considered. Nevertheless, it is a fact that there were several syndicates who were anxious to secure the valuable monopoly. The successful parties are Messrs. Mann and Mackenzie, two of the wealthiest and most experienced contractors in Canada, and it is likely that they will prove equal to the task. The government is to make a land grant, consisting of 25,000 acres of Yukon land for every mile of railroad built, or 3,750,000 acres in all. The land is to be taken in sections of eighteen square miles, alternate sections being reserved as public domain. In making its selections, the company must not infringe upon the rights already acquired by the miners. If the Yukon fulfills its present promise

it can be seen that the contractors are receiving an enormously valuable grant; but it must be borne in mind that the scheme is a purely speculative one, and that the contractors' risks are heavy. As an instance of this it is already reported that they are finding great difficulty in transporting the four or five thousand men necessary to build the road from Vancouver to the Stikeen, the accommodation of the ocean steamers being all secured by the army of gold hunters making for the Yukon.

SIDE DOORS OR END DOORS ON RAILROAD CARS.

One esteemed contemporary The Railroad Gazette has called us to account for our statements regarding certain affairs which are matters of fact and matters of belief in the mind of its editor.

In our issue of February 5 we made two statements in reference to the London underground railways, the first of which was to the effect that they had decided to use electric traction and the second that, on account of the numerous side doors with which their cars are provided, the discharge of passengers is quicker and the stops at stations briefer than on our own elevated roads, where each car provides only two means of exit for the passengers.

The Railroad Gazette in quoting the above says, "We know that it contains some misinformation and we fear that it is all misinformation." The information which it "knows" to be untrue is that relating to the length of stops at stations; the information which it "fears" may be untrue is that relating to electric traction. The "fear" as to our inaccuracy is explained by the fact that our contemporary "has not" itself "learned that any decision to change the motive power has been reached;" and its positive knowledge of the inaccuracy of our statement as to stops is due to the fact that the editor has personally timed the length of stops on both systems and found them to be longer on the underground roads.

The Johnsonian self-complacency which underlies this editorial criticism prepares the reader for the unblushing statement, a few lines further down, that in The Railroad Gazette of 1894 "he will find four editorial articles" on the subject, "which will probably give him more accurate comparisons of conditions as to speed," etc., "than he will find collected anywhere else in the English language"! Verily, the writer has the courage of his convictions; and if he is somewhat lacking in that saving grace of modesty which is supposed broadly to distinguish the technical and professional press from its daily contemporaries, it is consistent with the fact that in the matter of self-advertisement he is thoroughly in touch with a notorious phase of modern journalism which is just now attracting much unwilling attention.

But, to return to the points at issue, we can assure our readers that our information regarding the change to electricity on the underground roads is derived from a source which we have good reason to believe is more reliable than any to which The Railroad Gazette has, or is likely to have, access. As to the relative length of stops on the two roads, our critic states that he has found by personal timing that the length of stops on the underground roads was 30 seconds and on the elevated roads 12 to 15 seconds. It was once our misfortune, during a visit to London, to have to travel for some weeks in the smoky atmosphere of one of these underground roads. Being curious to test the advantages of side doors in the matter of quick loading and unloading of passengers, we made it a point to time the stops on several different occasions. We have not the notes at hand and cannot give the exact figures; but the average time was somewhere in the neighborhood of 15 seconds. During the last few days we have timed the stops on the Sixth Avenue road in this city, between Franklin and Forty-second Streets, and found that they varied in duration from 10 seconds to 33 seconds, according to the hour of the day and the importance of the station, the highest average being 21 seconds and the lowest 13 seconds.

We have taken up this subject again at some length, because we are convinced that for city and suburban traffic, in which it is of the greatest importance to shorten the stopping time at stations, the car with several side doors is superior to the car with only a door at each end. The objections to this system are more sentimental than real. It would be possible to use the side doors (one to each pair of seats) on American cars, without in the least destroying the distinctive characteristics of the latter, such, for instance, as the great length, the central aisle, and the generally commodious proportions. By the use of steel underframing and truss rods with a deeper pitch, the loss of strength due to cutting through the sides of the cars could be fully compensated. With cars so constructed, having a door to each pair of seats, or better, one to each seat, the time of loading and unloading during the rush hours would be cut down fully 50 per cent. We say this after a perusal of the "four editorials" to which the attention of the general public has been directed and we find that they fully substantiate our position. Mr. Vreeland, president of the Metropolitan Street Railway Company of this city, who, surely, should know some-

thing about rapid transit, once told the writer, in answer to his suggestion that double-decking the Broadway cars would relieve the congestion, that the capacity of his road when the cars were running under 10 seconds headway was determined by the rapidity with which passengers could be got on and off the cars. Other things being equal, this is also true of the elevated roads, and the figures given in the "four editorials" show the overwhelming superiority in this respect of the side door car. According to this self-accredited authority the underground trains consist of 9 cars seating 430 people and the elevated trains of 5 cars seating 240 people. The elevated trains discharge through 8 doors, an average of 30 persons to the door; the underground trains, according to the same authority, would discharge through about 48 doors, making an average of 9 persons to each door. To reach the exit each person would have to walk an average distance of 12 feet on the elevated and 4 feet on the underground cars.

If the speed of rapid transit is governed in large measure by the rapidity of loading and unloading, it is evident that three doors will do the work quicker than one, and this is the ratio, as shown by the unimpeachable authority of the "four editorials," in favor of the side door system. If the side door should be adopted for rapid transit—on long distance trains it is unnecessary—we may look for better results than are secured in London, where the roads are hindered by the existence of three different classes of cars. There is a slight delay, due to the passenger having to seek his own class car, which would not exist on our roads. The doors would all be opened and shut by a lever controlled by the brakeman, and instead of the 30 or 40 seconds' delay and crowding which is liable to occur at the end of each car at important stations during rush hours, there would be an instantaneous discharge at 6 or 8 doors per car evenly distributed along the length of the train.

THE HEAVENS IN MARCH.

BY GARRETT P. SERVISS.

The glory of the winter heavens lingers in the opening month of spring. Orion has not yet departed from the evening sky and Sirius still glows, with diamond brilliance, the brightest of the stars. But new constellations are gradually advancing from the east.

At 9 o'clock in the evening at the middle of March the visible arch of the Zodiac begins with Virgo rising, passes through Leo to Cancer on the meridian, and then declines through Gemini and Taurus to Aries setting. At the same hour the scarf of the Milky Way is flung across the sky from north to south, just west of the meridian. The Great Dipper, bowl downward, crosses the meridian about midnight.

THE PLANETS.

Mercury and Venus are the guests of the sun, and, as such, except to the licensed eye of science, withdrawn from mortal gaze. At the beginning of the month Mercury is in Aquarius and at the end in Pisces. It passes behind the sun (superior conjunction) on the morning of the 16th, and at the end of the month will begin to show itself in the sunset sky.

Venus pursues a course very similar to that of Mercury. Both move from Aquarius into Pisces. Venus is in the lead at the start, but swifter footed Mercury overtakes her on the 26th, after they have both arrived among the stars of Pisces, eastward from the sun. At the close of the month they may both be looked for over the western horizon on a clear evening, just after sunset.

Mars moves during March from the middle of Capricorn into the middle of Aquarius. At the opening of the month it rises about 5:30 A. M. and at the close about 4 A. M.

Jupiter will be the cynosure of all eyes that are turned to the starry heavens this month. The great planet rises about 8 P. M. on the 1st and before 6 P. M. on the 31st.

It is in Virgo, moving westward, from near the star Gamma toward Eta. No one who possesses a telescope, however small, will fail to turn it again and again upon Jupiter. The phenomena of his belts and moons have a perennial interest. They exhibit so much motion and such contrasts of color that the impression they make is of the liveliest description. In watching them one feels that it is indeed another world that he is looking upon, however different it may be from our world in its physical condition and environment. It is interesting to remark that recent studies of Jupiter, particularly those of Prof. Hough, continued almost without interruption for twenty years, seem to show that that planet possesses much more stability in its larger features than has generally been supposed. It is possible that we are on the eve of most interesting discoveries concerning the largest member of the planetary family.

On the night of the 8th Satellite I and its shadow may be watched crossing Jupiter's disk. The shadow will appear on the edge of the disk at 10:22 P. M. The satellite will follow at 10:47 P. M. The transit will last more than two hours.

On the 9th a very interesting series of phenomena occurs. When Jupiter has got above the mists of the horizon two black spots will be seen on his face. The one furthest south is the shadow of Satellite III; the other is the shadow of Satellite II. At 8:05 P. M. Satellite II will itself enter on the disk, and at 8:28 Satellite III will follow its example. Both the shadows will pass off before 10 o'clock. At 10:14 Satellite I will reappear from occultation behind Jupiter. Still later Satellites II and III will pass off the disk.

Saturn remains in Ophiuchus near Scorpio, rising about 1 A. M. on the 1st and about 11 P. M. on the 31st.

Uranus is in Scorpio between two and three degrees southeast from the double star Beta.

THE MOON.

March opens and closes with the moon near first quarter. The new moon of March occurs on the 22d. The moon is full on the 8th and in last quarter on the 15th.

The lunar conjunctions with the planets occur as follows:

With Jupiter on the 9th, with Uranus on the 13th, with Saturn on the 14th, with Mars on the 19th, with Mercury on the 22d, with Venus on the 23d, with Neptune on the 28th.

The moon is nearest the earth on the 14th and furthest from it on the 28th. The greatest libration east occurs about 10 P. M. on the 7th, and the greatest libration west about 4 A. M. on the 22d.

MISCELLANEOUS PHENOMENA.

A minimum of the variable star Algol, which will then be well placed, high up west of the meridian, may be observed at 7 P. M. on the 1st.

There are six recognized meteor showers in March, but none of them is rich or brilliant. Their dates and the constellations from which they radiate are as follows: March 4th, Virgo; 14th, Draco; 18th, Cepheus; 24th, Ursa Major; 27th, Corona Borealis; 28th, Draco. All except the first are in the northern quarter of the sky.

The sun enters the sign Aries and astronomical spring begins at 9 o'clock on the morning of the 20th.

THE OPIUM INDUSTRY IN AMERICA.

BY C. F. HOLDER.

An attempt to raise the opium poppy has been in progress for several years in California. The hot days seemed altogether favorable for the production of the plant and drug, but the accompanying cold nights and the absence of cheap labor proved fatal to the project, and it has been given up as a failure. The value of the drug as a means of money making was, of course, the incentive, and the extraordinary and growing demand for opium in all countries tells a suggestive story of the habit that has obtained a firm hold among the people of all races.

In the very oldest books of the Arabs the poppy is mentioned, showing that the use of the gum is one of the most ancient of practices. The poppy used for the purpose is *Papaver somniferum*, a plant discovered, in all probability, by the Arabs and carried from Arabia by man over large portions of the globe. At first opium was used as a medicine. Theophrastus was familiar with it, and Dioscorides, in 77 A. D., wrote a learned paper on its properties. Up to the twelfth century Asia Minor was the source of supply, and from then on it was gradually distributed over the globe. The Chinese first obtained the drug in the thirteenth century, it being used purely as medicine; but gradually its insidious effects were realized and it became so important a drug in a commercial sense that in 1757 the great monopoly was secured in India by the East India Company. The business rapidly increased from one thousand chests in 1776 to nearly five thousand in 1790. At this time the emperor Kea King fully realized the effect the drug was having upon his people, and in 1786 its importation was forbidden. Chinese caught smoking were flogged and severely punished. This not having the desired effect, those who were found using it were transported or beheaded. Even this did not affect the sale, and in 1825 the importation of opium into China had increased to 16,877 chests.

In 1839 the Chinese government made a desperate effort to drive off the English opium sellers by ordering off the English opium ships. This not being complied with, nearly thirty thousand chests of opium were destroyed, entailing a loss of ten million dollars. This led to the war and final treaty of Nankin in 1842.

The Chinese government appreciates the dangerous nature of the drug and its effect upon the nation, and has never ceased its endeavors to stamp it out; but without avail, and to-day China is probably the largest poppy producing nation. The provinces famous for it are Chekeang, Yunnan, while southwestern China produces 224,000 peculs, against 100,000 peculs from India. To-day over half the provinces of China produce opium, and the habit of opium smoking seems confirmed. Turkey is noted for its production, and the best opium used in the United States by druggists comes from there.

Some idea of the importance of the trade and the amount used can be obtained from the following: In Macedonia the crop is estimated at 140,000 pounds per annum. In Bengal, where it is a government monopoly, the output is equal to about 90,000 chests, valued at \$55,000,000. Persia produces about 10,000 chests; Egypt about \$10,000 worth annually, and Mozambique has 60,000 acres under cultivation. Opium has been raised in Virginia and Tennessee, as well as California, but owing to the lack of cheap labor and the uncertainty of the crops, due to frosts, the business is unprofitable.

Nearly all the opium smoked by the Chinese in this country comes from the Fook Hing Company, of Hong-Kong, which pays the government \$300,000 per year for the privilege of carrying on the business. The opium is packed in five-*tael* tins, which bring in San Francisco \$8 each. Some excessive smokers use from four to eight dollars' worth a week.

It has been estimated that in San Francisco thirty per cent of the Chinese are addicted to smoking and that ten per cent of the entire population of Chinatown are habitual "opium-drunkards." The drug is smoked as freely as tobacco. First, there are the opium dens. There are scores of these dens in the Chinese quarter of every large city. There the Chinaman can buy his pipe and smoke in peace. In San Francisco white people are forbidden to visit these dens, but they have such places of their own, which are well known to the police, and the vice is ever spreading and increasing.

It is somewhat difficult to determine the amount of opium received in San Francisco, but during the past decade about 600,000 pounds has been taken into that port. In one year the importations for smoking purposes amounted to 100,000 pounds. Previous to 1883 the duty was but \$6 per pound. At that time it was increased to \$10 per pound on the smoking extract and \$1 per pound for crude opium. This had little or no effect upon the trade, as consumers were obliged to have the drug at any price. In 1889 the McKinley bill raised the duty to \$12 per pound on opium of all kinds which contained less than nine per cent of morphia. Even under this restriction, and despite the fact that the exclusion bill was in full force, over 63,000 pounds of opium were legitimately introduced in that year, and probably twice as much more smuggled in, the government receiving nearly a million dollars from the duties.

At the present time the importation of crude opium is decreasing. This is due to the law of 1889, which states that only native Americans can legally manufacture the extract, and the law also demands a tax of \$10 per pound. The duty on the best Patna opium is \$12 per pound, and as it requires two and one-half pounds of this to equal one of the extract, this would make the latter cost about \$30 per pound. To this would have to be added \$10 per pound revenue tax, which makes a total of \$40 per pound on American made opium extract. It need not be said that very little is made, as the Chinese preparation can be had for \$18 per pound. The great demand for the extract has induced smuggling, and illicit stills were started everywhere. Opium was and is still smuggled in at the Canada and Mexican lines. It is landed at the islands off shore and brought in by Chinese fishermen, smuggled in on steamers, dropped into the bay and the law evaded in numerous ways familiar to the "heathen Chinese."

In San Francisco hundreds of "opium kitchens" were started. These were extremely difficult to find. Some were established in boats, others in dark cellars, others in the rear of private dwellings. Scores have been closed up by the police, yet some undoubtedly thrive, just as the whisky distillers escape the law in the wilds of Kentucky and Tennessee. The city of San Francisco has aided the government in restricting the sale. In 1881 the city passed a bill declaring it unlawful for any one to sell opium for smoking purposes without a license, the amount of the license being gaged by the amount of business. Thus if a den did a business of \$5,000, the owner was charged \$150 for the privilege. In 1889, at the earnest request of reformers, an ordinance was passed making it illegal to sell opium without a physician's prescription. There is also a law which makes it illegal for any one to keep or even visit an opium house. Three months' imprisonment is the punishment, but this has no effect. The dens are crowded, as every tourist who goes through Chinatown knows, and the only result is that whites are not found in the Chinese dens; they start dens of their own.

The difficulty of conviction lies in the universality of the habit, as it pervades the home and business. Wherever the Chinese are found there will be the odor of opium. They smoke it as Americans do tobacco. Nearly every well regulated Chinese home has its opium smoking outfit, where the guest is invited to smoke. Many of the merchants have such a retreat in the rear of their shops, into which a customer may be asked to smoke as an American merchant is invited to take a cigar. The difficulty, then, lies in the impossibility of drawing the line between professional and private opium dens.

AN EFFICIENT TIRE BOLT WRENCH.

To facilitate screwing up or unscrewing the nuts on bolts used for holding the tire to the rim of a vehicle wheel, a job which often presents considerable difficulty, especially when wheels are to be repaired, the wrench shown in the accompanying illustration has been invented and patented by Lewis C. Wiley, of Smiley, Texas. In the frame or stock of the wrench is journaled a shaft having a squared end for engagement with the chuck of an ordinary brace, while on its other end is a gear wheel in mesh with a gear wheel on a second shaft similarly journaled, and loosely supporting a socket, resting against a spring on the shaft. The socket has in its forward end a diametrical recess adapted to engage two sides of a nut placed on the end

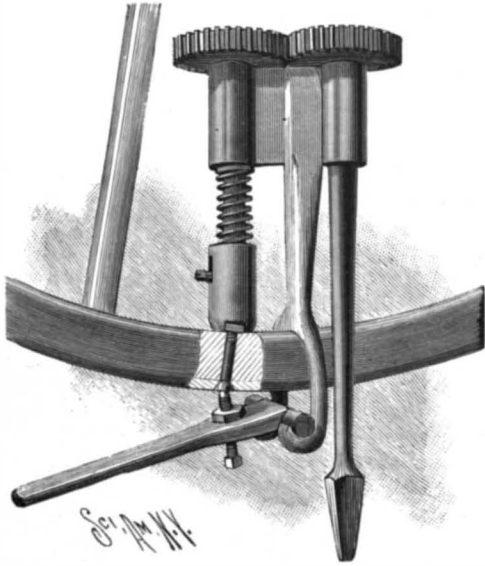
**WILEY'S TIRE BOLT WRENCH.**

of a bolt, on the inside of the wheel rim, and a vertical opening for the passage of the projecting end of the bolt, there being also in the side of the socket an elongated slot through which passes a screw, to cause the socket to turn with the shaft and slide freely thereon. The head of the bolt, on the outside of the tire, is engaged by the chisel end of a tool adjustably held in a lever formed with trunnions placed in hooked bearings on the lower forked end of a post depending from the frame, the rim and tire of the wheel passing through the forked end of the post. The lever can be readily placed in position to engage the tool with the head of the bolt, while at the same time the nut is engaged by the socket, when, on turning the brace, great power may be exerted to screw up or unscrew the nut from the bolt.

AN AUTOMATIC ACETYLENE GAS GENERATOR.

The ideal of perfection of an illuminant is undoubtedly presented by acetylene gas. Incomparably more brilliant than the incandescent lamp, it has a softness and steadiness that make it the most perfect of all illuminants, being restful and natural to the eye, and yet with a power and penetration not to be excelled even by the arc lamp. For these reasons there has been, ever since its experimental introduction to the public some three years ago, a very general desire, especially by those who have seen the light in use under favorable circumstances, that the methods of its production might be so improved and perfected that all element of danger would be removed, and the light furnished at a cost and under conditions that would be generally available to meet the large public demand that would, undoubtedly, immediately follow.

An apparatus designed to meet the desired ends, that is, to furnish the gas under pressures which can never become excessive, the supply being always automatically regulated by the quantity of gas withdrawn in use, and in which every safeguard is provided against accident, is represented in perspective and

section in the accompanying illustrations, and is now being manufactured by the Niagara Falls Acetylene Gas Machine Company, of Niagara Falls, New York and Canada. The manufacture of the calcium carbide from which, as is generally understood, the gas is produced, by the simple addition of regulated quantities of water, has now become a well established industry, and the price of the carbide is being proportionally reduced with the growth of its production. The method of its manufacture, from lime and coke, or charcoal, in fire-brick furnaces, by means of an electric current of high intensity, has often been explained, the carbide coming out in the form of great pigs of 500 pounds weight, which, on being broken up, resemble chunks of iron ore. The carbide is then placed in tanks or drums, to be sealed up airtight, or the moisture of the air would gradually effect its decomposition. The wholesale price of the carbide is now about \$75 a ton, and it is estimated that one pound of carbide will produce a quantity of acetylene gas equaling 75 feet of coal gas in illuminating power, or about equivalent to 60 cents per 1,000 feet for coal gas. These figures are, however, largely based on theory, and an extended practice might very materially modify them.

As shown in our illustrations, the smaller of the two principal tanklike receptacles is the acetylene gas generator, having a tightly fitting cover, the carbide being placed on a grate about midway of the receptacle, there being a handle by which this grate may be agitated to throw down the limelike residuum of the dissolved carbide, and a covered opening near the bottom through which such residuum may be removed, after fitting thereon a telescopic device which prevents the escape of dust. The water is discharged upon the carbide from small openings in a plate at the top of the generator, the discharge being automatic, from a pipe in communication with the tank in which the gas holder moves up and down on a guide pipe, according to the pressure of the gas, as indicated in the sectional view. The water supply tank connects with a small tank in which is journaled a tip tank, which automatically empties itself as it becomes gradually filled. There are adjacently supported connected water chambers, in one of which is a displacement float connected by a rod to the dome of the gas holder, the connection being such that, on the downward movement of the dome, as the gas becomes nearly exhausted, water will be discharged into the tip tank, to flow thence into the generator. The discharge of this measured quantity of water causes the generation of sufficient gas to raise the dome and the displacement float to their original position, and the operation continues thus automatically, with the certainty that the gas pressure cannot be unduly raised. It is said that the pressure never exceeds $1\frac{1}{2}$ ounces to the square inch.

The machine represented is especially designed for use in private houses, offices, stores, etc., or any place where gas or electricity is now used. There is not a valve or cock to wear out or be neglected or forgotten—a very desirable feature when it is remembered that the machine is so often likely to be in the hands of people of no mechanical knowledge. The machine may be connected with the ordinary gas piping of a house, substituting for the present gas burners a special form of burner or tip for the burning of the acetylene gas. For an equal amount of light the acetylene gas gives off only about one-fifth the heat produced by ordinary illuminating gas.

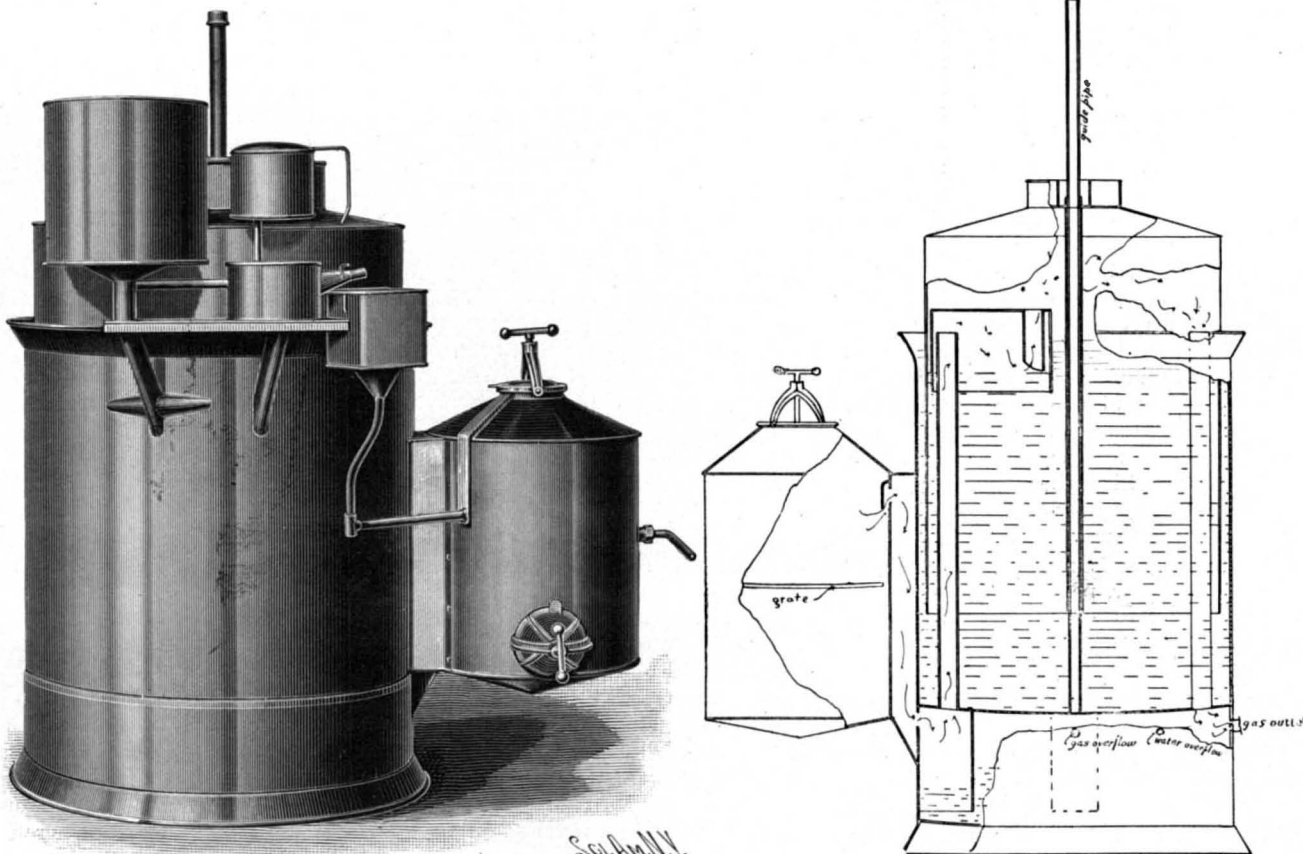
**AN AUTOMATIC ACETYLENE GAS GENERATOR.****DISCHARGE NOZZLE FOR FIRE ENGINES.**

A device especially adapted for use in city fire departments, and designed to receive and effectively discharge the water from several fire engines or other sources, is represented in the accompanying illustration, in what is termed a "fire battery," and has been patented by Thomas A. Ready, of No. 126 Hudson Street, New York City. Mounted in trunnion bearings on a carriage which has trail stocks is a nozzle adapted to rock vertically, and having at its rear end a number of inlet nipples. One of the trunnions is connected by different pinions with a hand wheel, a dog having a handle engaging one of the pinions, to facilitate regulating the angle of elevation of the nozzle, which may be effected by one person. Movable through openings

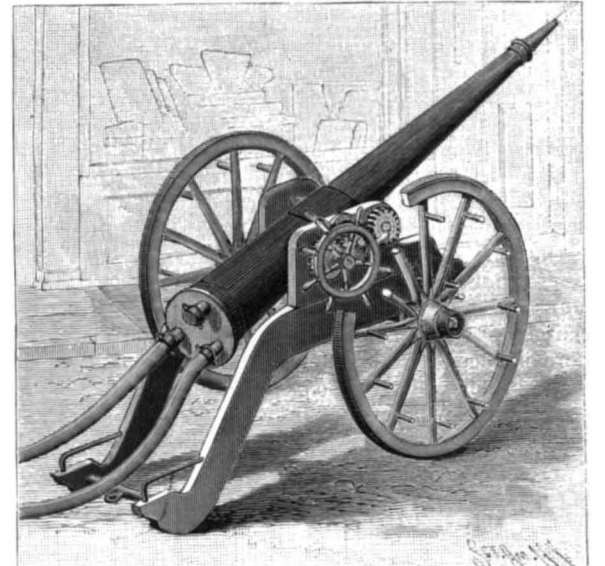
**READY'S FIRE BATTERY.**

in the side pieces of the carriage are blocking rods adapted to engage the spokes of the main wheels when the apparatus is stationary, and these wheels also have hand rods on their spokes to facilitate moving the battery from one position to another. At the ends of the trail stocks are iron loops to receive straps or ropes when it is desired to run the battery down a stairway into a cellar or basement, should the fire there be too hot to allow the firemen to enter, and a ring on a cross-piece is adapted for connection with an engine or hose carriage in moving the apparatus to or from a fire.

The Japanese Rug Industry.

The seat of this industry is the town of Sa'kai, situated about eight miles south of Osaka. The rugs made are principally from jute, the number of people employed in the manufacture being about 9,600, mostly children between seven and sixteen years old. In the course of last year, says The Dry Goods Chronicle, the Sa'kai weavers have made a step forward by turning their attention to the manufacturing of wool rugs, and they are now able to turn out a very creditable article, which, in appearance and durability, is almost equal to a Turkish carpet. Although this branch of the industry is yet in its infancy, it employs 480 weavers on 120 looms, and can turn out 120 square yards daily. The warps and weft are cotton, the filling wool yarn.

Most of the wool yarn is manufactured from Chinese raw wool spun in Osaka. An important improvement in the rug business is the attention now paid to dyeing colors. Fast dyes and beautiful shades are taking the place of their former attempts in this respect, and there seems no question but that the quality of their work is now much superior to what it was a year ago.

In a review of the past year given by The Progressive Age it is stated that the demand for calcium carbide is far in excess of the supply, and that plans are now maturing for the construction of an enormous plant to utilize 100,000 horse power entirely for its production.

SUBMARINE MINING AND TORPEDO WARFARE.

In view of the widespread interest in torpedoes and submarine mines which has been awakened by the blowing up of the "Maine," we have prepared the following account of these destructive and little understood weapons. Speculation has been rife as to the manner in which the disaster occurred, and a widespread belief undoubtedly exists that the ship was blown up by design, yet few people have any clear idea of the difficulties involved in the task of blowing up a warship under the circumstances in which the "Maine" was placed. We shall not attempt to go into the history of torpedo warfare, but will merely explain the present methods of attack with high explosives.

The attack against a ship with gun-cotton, dynamite and similar substances is carried out by firing them in shells from pneumatic guns, by exploding them at the head of a torpedo which is automatically propelled against the submerged hull of the ship, and by placing them in submerged mines, which are exploded mechanically on being struck by the ship or are fired electrically from a station on shore. The automobile torpedo is a cigar-shaped steel vessel, usually about 25 feet in length, whose interior is divided into three main compartments. The first compartment at the head contains a heavy charge of gun-cotton; the second forms the air receiver for the storage of compressed air; and behind this is the engine room, in which are the propelling engines and the mechanism for controlling the course of the torpedo. The best known type is the Whitehead, which is in almost universal use throughout the world. It is started on its course by firing it from a launching tube, by means of a charge of compressed air or a few ounces of gunpowder. One of our illustrations shows a torpedo in its flight from the tube to the water. On reaching the water its propellers, which have been set in motion by its discharge, drive it at a speed of 30 knots an hour against the submerged hull of the ship, the proper depth being maintained by automatic mechanism within the torpedo. On its striking the ship, the gun-cotton is exploded by the impact.

Another torpedo of the automatic type is the Howell, invented by a United States naval officer of that name. It is a cigar-shaped vessel, not unlike the Whitehead in appearance; but its motive power is entirely different. It is driven by the momentum of a flywheel contained within the shell, and it is started, like the Whitehead, from a launching tube. The flywheel is set spinning at a high velocity by means of a suitable motor which is disconnected before the torpedo is fired, the stored-up energy in the wheel serving to turn the double propellers and drive the torpedo at a high speed toward the ship.

The Sims-Edison torpedo, of which we present an illustration, belongs to the class of what are known as dirigible torpedoes. These are connected by electric cables with a station on shore, from which the speed and steering are controlled. The cable contains an outer and an inner conductor, the first of which conveys current for driving the motor in the torpedo, the other carrying current for exciting the magnets which control the steering gear. The cable is extremely flexible and has a total length of about two miles; it is wound on a reel which is within the torpedo and unwinds as it travels. The cigar-shaped torpedo proper is rigidly suspended from a boat-like float, upon which are two vertical rods which project above the water and indicate to the operator on shore, or on the ship, the position of the torpedo. The little rods carry flags by day and colored lights by night.

The Victoria is an Australian invention and is controlled from the shore or a ship like the Sims-Edison. It differs from the latter in being entirely submergible below the water, and in using air as its motive power. When it is started it hauls a cable after it, unwinding it off a reel on shore, and the first part of

its course is covered at moderate speed. When the operator has guided it to within striking distance of the enemy, a current is sent through the cable which releases the reel on the torpedo and allows its cable to unwind. At the same time the current starts the air engines at full speed and the final dash for the ship is made.

The Brennan is another torpedo of the dirigible type, which acquired considerable fame from the fact that it was taken up by the British Admiralty and subjected to exhaustive experiments. Like all the machines of its class it has proved only moderately successful, and in common with them is not regarded with much favor by naval authorities. The Whitehead is par excellence the torpedo of the present day, and the

charge of high explosive, usually gun-cotton, and contains at its base some exploding or detonating device for setting off the mine. Of the three kinds mentioned above, the mechanical mine is less used than the other two. For purposes of firing, cables are led from the igniting charge to an observation station conveniently located on shore. The mines are built in a variety of shapes, some of them being cylindrical, with rounded ends, and others conical, with the sides somewhat bulging. The observation mines possess considerable advantage from the comparative simplicity of their construction, and the fact that when they are laid they may be adapted to allow the passage of friendly vessels while barring those of a hostile power. When they are placed on the bed of the river or harbor, they are

known as ground mines. In some countries this type is of the roughest and cheapest construction, consisting of a rough cast iron case with projecting legs to enable it to anchor itself

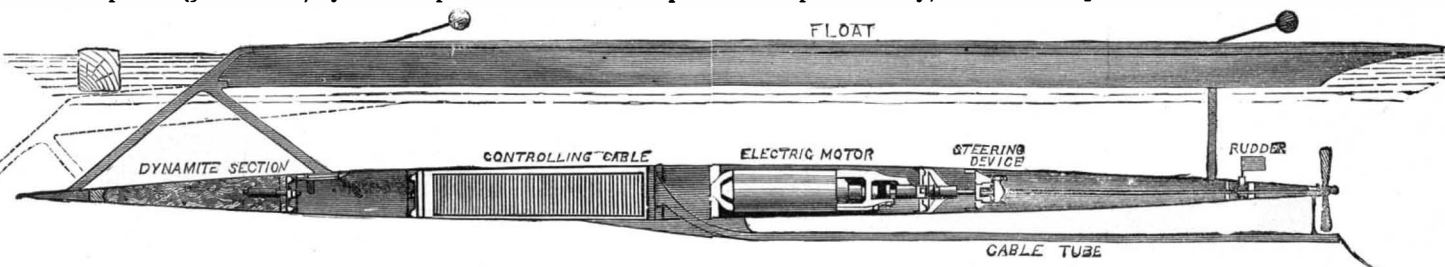

THE SIMS-EDISON TORPEDO.

recent struggles in Chile, Brazil and the East have served to demonstrate its deadly power.

It will be evident from this brief review that torpedo operations are not so secret or easy of concealment as is popularly supposed, and there are features connected with it which make it highly probable that the sinking of the "Maine" in Havana Harbor was not done by a mobile torpedo. The torpedo itself is a bulky affair, and, together with its launching gear, could never have been brought within striking distance without attracting attention. The Whitehead, if launched from a neighboring ship, would have been accompanied by a report and a splash as it left the gun and plunged into the water (see illustration), which would certainly have attracted attention on board the "Maine." If the Sims-Edison or any other form of dirigible torpedo had been used, it is inconceivable that the necessary plant could have been in existence on shore without detection. Moreover, it would have been next to impossible to run a torpedo, with a cable trailing behind it, through the crowded waters of the harbor, without its becoming entangled with the ferry boats or ship-

securely in the mud. There is practically no limit to the size of these mines; lying deep down beneath the surface they are entirely hidden from view, they are not liable to be laid bare with the fall of the tide, and they contain sufficient explosive to insure that any ship within a radius of fifty feet will be destroyed.

Another type is known as the buoyant mine. These are made considerably larger in order to secure sufficient displacement, and they are anchored by a cable of such a length as to insure that they will float at the required depth below the surface. They have an advantage over the ground mine in the fact that they lie nearer to the object of attack, and, therefore, do not require to be filled with such a heavy charge of explosive.

Observation mines may be fired by one or two observers. If by one observer, the mines are laid down in rows, the lines of which converge to the observation station. All the mines in one row are connected so that they can be simultaneously fired when the ship is passing the range line. When the mines are connected with two observers, they are laid according to a system of cross observation, by which it is possible to fire any particular mine when the ship is above or in close proximity to it.

The great advantage of the electrical contact mine is that a very small charge of gun-cotton suffices for the destruction of a ship as compared with that which is necessary in a buoyant or in a ground mine. These mines are provided with an automatic circuit closer, by means of which, on the mine being struck by a vessel, a current is sent to the observing station, from which the operator fires the mine. In one form of contact mechanism a vertical pendulum is hung in such a position that when the mine is struck it will swing over and close the circuit by striking a contact point. In the case of ground mines the circuit closer may be anchored to them by a cable and float above them at the proper distance beneath the surface. In the buoyant mines the circuit closer is contained within the shell of the mine itself. It will be seen that in this system the operator has perfect control of the mine, and can permit a friendly vessel to pass, by failing to close the

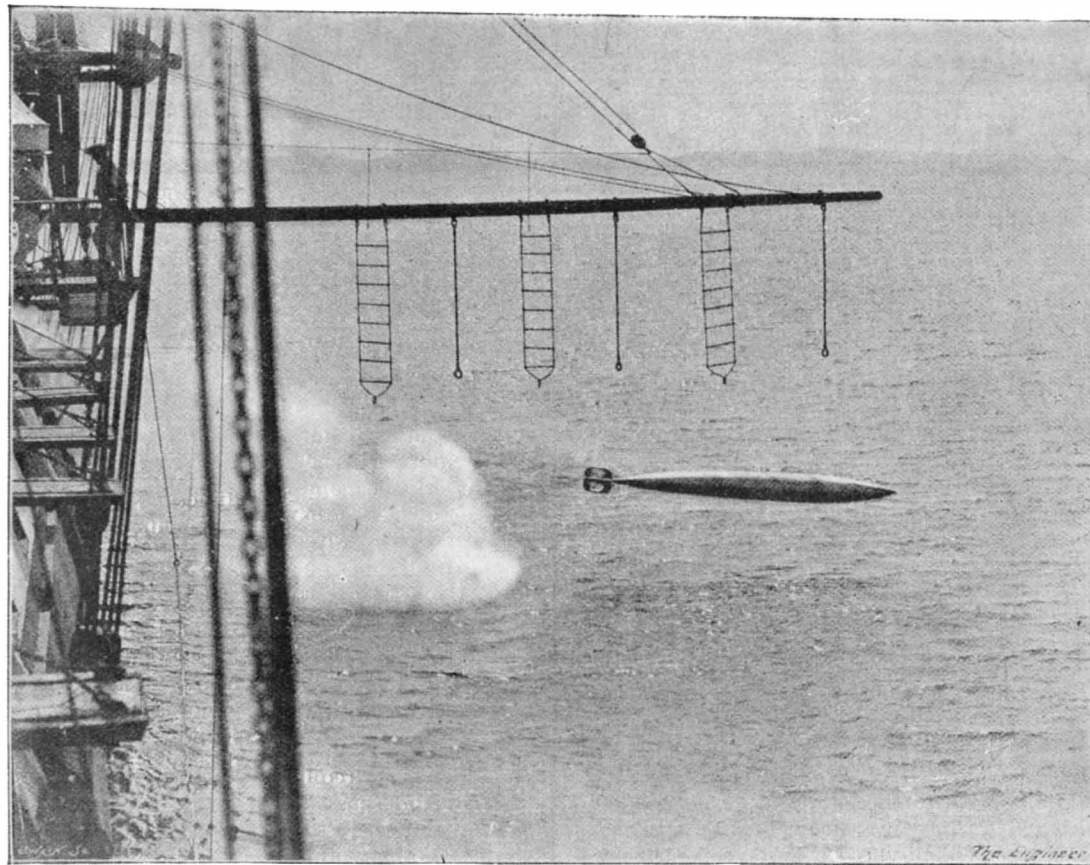

DISCHARGING A WHITEHEAD TORPEDO.

firing circuit when the warning is received, while, at the same time, he may have his finger upon the button ready to sink a hostile ship the instant that the warning is automatically sent in from the mine.

It is a question whether a submarine mine of the ordinary type, with its charge of from 50 to 200 pounds of gun-cotton, would be sufficient to account for the absolute destruction which appears to have been wrought in the forward half of the "Maine." It is, of course, conceivable that the explosion of a buoyant or floating mine of the ordinary type in close proximity to the ship might have caused the greater and more destructive explosion of the magazines within the ship itself, and this theory would be consistent with the double report, the first muffled and the second louder and more terrible, which many of the eye witnesses appear to have no-

ping. The lights which a dirigible torpedo must carry by night to indicate its course would be visible from the shore and from all the shipping near it.

It may safely be said that if the "Maine" was destroyed by some external cause, it was not a torpedo, but some form of submarine mine that wrought the mischief.

Submarine mines are of three different kinds: 1. Observation mines, which are fired from shore when a ship is seen to be in their vicinity. 2. Electrical contact mines, which, on being struck by a ship, give notice to the operator, who, by pressing a button, fires the mine. 3. Automatic mines, which are self-firing on being struck by a ship.

Generally speaking, the mine consists of a steel shell of comparatively light plating which is filled with a

ticed. Outside of the various kinds of submarine mines there is one other possible device which might be answerable for the catastrophe. It is conceivable that some form of torpedo provided with an automatic detonating device operated by clockwork might have been placed beneath the hull of the ship, attached thereto and left to do its work. Such devices are not unknown, nor considered impossible by the experts in torpedo warfare and mining operations. Of course, the difficulties in the way of carrying out such a scheme would be enormous.

In summing up, it is evident that, if the "Maine" was blown up from the outside, it is extremely improbable that the work was done by an automobile or a dirigible torpedo, and the only practical device would have been some form of submarine mine. It is simply common justice, in view of the atrocious and unspeakable nature of such a crime, to point out that there are two considerations which render the submarine mine theory very doubtful. The first is that the explosion of dynamite in a body of water invariably causes the death of all the fish within a wide radius, and the second is that the great upheaval of water is followed by a big wave which travels in every direction from the scene of the accident. We are aware that it has been denied that there are any fish in the harbor of Havana; but we are assured by those who have been long resident in Havana that the harbor abounds with fish.

Either of the above phenomena would, to our thinking, provide very strong proof that the "Maine" was blown up from below; but, so far, we have failed to find any evidence offered by eye witnesses that either result followed. Both of these points will undoubtedly be the subject of close examination on the part of the Board of Inquiry, and will furnish strong presumptive evidence, one way or the other, apart from the condition of the wreck itself.

Sugar-eating Nations.

The sugar crop of the world amounts in a normal year to about 8,000,000 tons, of which the larger part, about 4,500,000 tons, comes from beets and the balance, 3,500,000 tons, from sugar cane. Of the latter the largest proportion comes from the West Indies and a large amount from the island of Java, says the N. Y. Sun.

Among the countries producing beet sugar, Germany comes first, with about one-third of the world's crop; then Austria, with about as much; and then France, Russia, and Belgium and Holland together, with substantially the same quantity.

In respect of the production of beet sugar in the United States, there has been a vast increase since the establishment of the McKinley tariff in 1890. The year previous the American product was 2,800 tons. Two years later it was 12,000 tons. Four years later it was 20,000 tons. Last year it was 43,000 tons, and the product is on the increase. The McKinley tariff established between July 1, 1891, and July 1, 1905, a bounty to be paid by the United States government to sugar producers, with a view of stimulating the industry and compensating those engaged in it for the changes made in the duty upon imported sugar.

Among scientists the opinion has been general that a moderate amount of sugar, like a moderate amount of salt, should enter into the dietary of the people of each nation; but it is only when the figures of the consumption of sugar are examined that it is seen that the quantity consumed varies radically, and it is a curious fact that in those countries in which the maritime spirit—the spirit of navigation, commerce, travel and colonization—is strong there is a very considerable consumption of sugar per capita; whereas in those countries in which these qualities are not predominant among the inhabitants the consumption is smaller. In England, first among the maritime nations of the world, the consumption of sugar is 86 pounds a year for each inhabitant. In Denmark it is 45, in Holland 31, in France 30, and in Norway and Sweden 25, whereas in Russia it is only 10, in Italy 7, in Turkey 7, in Greece 6, and in Servia 4. The consumption of sugar seems to have very little connection with or relation to the production of sugar; for in Austria, the sugar product of which is large, the average consumption is only 19 pounds, while in Switzerland, in which there is no production to speak of, it is 44. And another curious phase of the matter is that there is a great disparity in the consumption of sugar in the two tea drinking countries, England and Russia. The large amount of sugar consumed in France is attributed in part to the fact that the French confectioners and candy makers, and more especially those doing business in the city of Paris, use in their trade enormous quantities of sugar in a year, adding abnormally to the average consumption of sugar in the French republic.

AN institute bearing the name of Christopher Columbus has been started in the port of Genoa on board a vessel, which has been specially adapted to the purpose, with the object of providing instruction for master mariners, machinists, electricians, torpedo engineers, etc. This is the only institute of the kind which exists in Italy.

The Draining of Lake Fucino.

A remarkable undertaking has been very quietly completed in Italy, says The American Architect. From time to time, for the last forty years, the technical journals have given partial accounts of the work which was going on for draining the Lake Fucinus. This lake lies in a valley of the Apennines, some seventy miles southeast of Rome, and about one hundred and twenty from Naples. This valley, which is nearly two thousand feet above the sea, is entirely surrounded by mountains so that it forms an inclosed basin, occupied partly by very fertile meadow land and partly by the water of the lake. Unfortunately, the proportion between the land and the water is very variable, so that, after a series of rainy seasons, the farms which had been tilled for years, and even the habitations of the farmers themselves, become submerged in the lake, to reappear perhaps fifteen or twenty years later. The advantages of draining the lake, and reclaiming the sixty thousand acres or so of rich land which it covers, have been obvious for many centuries, and history represents the Æqui and Marsi, who inhabited the territory, as appealing to the Roman commonwealth, long before the imperial era, for aid in preventing the periodical inundations of the lake. In the time of Claudius operations were really begun in earnest by the central authority, and the skill and energy of the Roman engineers were sufficient to cut a tunnel, more than four miles long, partly through hard rock and partly through disintegrated ledges of the most dangerous kind, under the mountains to the little river Liris, which afforded an outfall to the sea for the lake waters. It has been supposed, in modern times, that this enterprise, on which the imperial government is recorded to have spent eighty million dollars, was abandoned before completion, but we now know that it was carried through successfully, and that it drained away the water of the lake until it became gradually choked by the fall of loose material, which the science of those days was insufficient entirely to prevent. Moreover, it has now been learned that the Roman engineers, when the tunnel was obstructed, either just before or soon after completion, by a great fall of loosened rock from the roof into it, started again, with characteristic Roman perseverance, and cut a tunnel around the obstruction.

In the course of ages, the accumulation of stones and rubbish so completely interrupted the flow of water that the tunnel was practically useless, and the periodical rise and fall of the lake waters became as troublesome as ever. Attempts were made by some of the popes, and by one or two of the kings of Naples, to provide drainage, but they ended in nothing. At last, some fifty years ago, a company was formed, the capital of which was subscribed in England, to carry out drainage works, and English engineers were sent to study the problem; but, after a few trials, the difficulties of the enterprise were found so great that operations ceased. Then Prince Torlonia, a rich banker of Rome, who was a large stockholder in the company, bought the remaining shares, and resumed the work on his own account. Three French engineers were employed, and under their guidance the labor of forty years has now been carried to a successful issue, and the waters of the lake pour through the tunnel, at the rate of forty-eight cubic meters per second, into the sea. A history of the work was published some time ago, which should have great interest for engineers, but the Torlonia family is said, for some unexplained reason, to have bought all the copies in booksellers' hands. However, the main facts are well known. The French engineers began their work by measuring the inflow into the lake and the capacity of the channel of the Liris, so that their tunnel could be proportioned to both, and the accuracy of their conclusions may be inferred from the fact that the tunnel, which is about fifteen feet in diameter, is filled to within eighteen inches of the top by the flow. In general, the new tunnel follows that of the Roman engineers, but it is much larger, the Romans having evidently no conception of the capacity required. Moreover, the Roman engineers did not possess instruments like ours, and the alignment of their tunnel was found to be irregular, sometimes falling below the true direction and sometimes rising above it, so as to form a succession of traps. The formation, even where the rock is firm enough to keep in place without lining, is full of water-bearing seams, and the work was one of great difficulty and danger throughout. The Roman engineers had adopted a curious mode of lining, consisting in shoring the walls and ceiling of the tunnel with timber uprights and planks, and substituting by degrees concrete for the planking. As it was necessary to leave the uprights until the end of the operation, the concrete was filled in around them, and they were finally cut off flush with the concrete surface. Of course, they soon rotted away, leaving holes, through which water and mud came freely, so that this ignorance of the properties of timber must have had much to do with the choking of the tunnel. The French engineers, of course, lined their work in the modern fashion, and there is every reason to believe that the present tunnel will endure for many centuries.

Two Great Cargo Carriers.

There have just arrived in New York the two largest cargo carriers in the world, the "Cymric," of the White Star Line, and the "Pretoria," of the Hamburg American Line. Both of the vessels have just made their maiden trip, one from Liverpool and the other from Hamburg. The "Cymric" is 600 feet long, 64 feet beam and 42 feet deep, with a gross tonnage of 12,340 tons and a displacement of 23,000 tons. She has two sets of quadruple expansion engines whose aggregate horse power is 6,500. On her trial trip the "Cymric" made about seventeen knots. Her time from Liverpool was 11 days 2 hours and 49 minutes; the average hourly speed was 11.53 knots. Her commander says that the "Cymric" is the steadiest ship he has ever been aboard. The fifty staterooms of the "Cymric" are larger than those of the ordinary passenger ship. All the cabin passengers can be seated at once. No second cabin passengers will be carried, and she has accommodations for 800 steerage passengers, and more may be taken by utilizing some of her cargo space.

The "Pretoria" is next to the largest cargo carrier afloat, the "Cymric" only exceeding her. She is 586 feet long, 62 feet beam and 42 feet deep. She has twin screws driven by quadruple expansion engines; she measures 12,800 gross tons and can carry nearly 14,000 tons dead weight and about 20,000 tons cargo measurement, which, her agents say, might be represented by the contents of 25 trains of 25 freight cars each. The "Pretoria" has accommodations for 328 cabin passengers and 800 steerage passengers. She made the run from Hamburg in 11 days.

A Primitive Maya Jewsharp.

Mr. M. H. Saville gives the following interesting information in a recent note in the American Anthropologist: The ancient forms of musical instruments known to have been used in Yucatan have been almost entirely superseded by those introduced since the Spanish conquest. In some of the interior pueblos the tunkul, or ancient wooden drum, is still used on feast days. "During the winter of 1890-91, while engaged in explorations at the cave of Loltun, we employed a number of Mayas who came from small villages in the interior remote from Spanish influences. Their evenings were passed in singing plaintive melodies in their native tongue, accompanied by a primitive form of stringed instrument which I have never seen described. It was called hool, and consisted of a piece of ropelike vine (ohil) stretched between the two ends of a pliable stick, making a bow about two feet long. One end of this bow is placed near the face, about one-third of the distance from the end, so that the mouth covers but does not touch the string, forming a resonator. Between the string and bow a piece of wood is placed in such a manner that it may be pressed against the string or relaxed at will. The tones are produced by tapping on the string, and somewhat resemble those made in playing a jewsharp, but are more agreeable to the ear. Variation of tone was produced by varying the pressure of the stick upon the string and also by the opening or partial closing of the mouth. The music is weird and not unpleasing."

Reversing in Steam Turbines.

Mr. Parsons, of steam turbine fame, has succeeded in producing a turbine of the general type which is known by his name which is capable of running in the reverse direction. At the time that the performance of the "Turbinia" startled the marine world, it was pointed out that such a boat would be useless for torpedo warfare because she was unable to reverse her engines. To remedy the defect Mr. Parsons at first proposed to install a separate motor for running astern—an obviously uneconomical arrangement. It is now stated that by using a system of "butterfly" reversing steam valves a motor is constructed in which the steam may be made to flow through the blades of the turbine in either direction—the whole horse power of the engines being thus available for going astern. We shall hope to give further details in a later issue.

The Current Supplement.

The current SUPPLEMENT, No. 1157, contains twenty-four articles, thirty-two short notes and twenty-two illustrations. The contents of this number by their variety will appeal to all our readers. The latest portrait of the Emperor William II. of Germany is accompanied by a biographical sketch. "My Recent Journey from the Nile to Suakim" is an interesting article by the celebrated war correspondent Frederic Villiers. "The Causes of Poverty" is an article based on the report of the Committee of Statistics of the New York Charity Organization Society, and is an important addition to sociological literature. "Machine Moulding Without Stripping Plates," by E. H. Mumford, describes a moulding machine. "Artificial India Rubber" and "Deep and Frosted Etching on Glass" are technological articles. Electricity is represented by "The Koppel Electric Locomotives" for narrow gage and pioneer lines and "Liquid Rheostats."

Correspondence.

Railway Train Lighted with Acetylene Gas.

To the Editor of the SCIENTIFIC AMERICAN :

The Pontiac Pacific Junction Railway express train has been successfully lighted with acetylene gas. The train consists of the ordinary postal, express and baggage, second and first class cars. The gas is generated by a 30-light Niagara Falls acetylene gas machine placed in the baggage car. Each car is regularly piped and supplied with six 50-candle power burners. The pipes are connected with rubber hose between cars, with hose cocks. It is a through express, requiring no shunting of cars. The train has been running a month with the new light, and the management is so satisfied with their experiment that they propose to light all their trains and stations with it. The new illuminant has had a severe test. The vibration of the car does not affect the steadiness of the light. Only once were the lights extinguished, and that was by the impact of the train against a huge snow drift almost as solid as a sand bar. They were relighted at once and caused no inconvenience beyond the temporary darkness, and for a few moments the smell of escaping gas. Frost 20° below zero had no effect on the gas passing through the rubber connections between cars. Am I right in claiming for the Pontiac Pacific Junction the honor of being the first train in America to be lighted with acetylene gas?

A. HOLLAND.

Ottawa, Canada, February 20, 1898.

Snake Charming.

To the Editor of the SCIENTIFIC AMERICAN :

My attention has been called to an article in your paper, in which your contributor states that he considers the power of snakes to fascinate birds is an exploded idea. I should like in reply to give an account of an occurrence which took place in my presence while traveling through the mountains of Kern County, California, and which I think goes far to prove the contrary.

I was riding and had off-saddled to eat some lunch when I was attracted by an unusual excitement among a flock of small birds in a neighboring tree.

On looking up I saw stretched along a limb a gopher snake, and in front of it about 18 inches distant was a bird, whose companions were making the noise that had attracted me. The bird was perfectly motionless and to all appearance was looking straight at the snake, which was gradually creeping toward its prey. When about 8 inches away, it struck and caught the bird by the breast; the latter at once started struggling to free itself, its companions trying to help it by beating the snake with their wings, but without avail.

The reptile then lowered itself toward the ground, hanging suspended by its tail for a few moments before it dropped; having done so, it lay still for a few minutes, but upon my making a movement, it dropped its prey and made off.

This incident I think proves that this particular snake at any rate had some power of fascination, and I would call the attention of your contributor to the actions, or rather want of action, in bird, as although the snake was in full view of it all the time, and notwithstanding the fact that its companions were doing all in their power to drive the snake away, it still remained passive, and apparently powerless to move.

W. R. MASON.

Bakersfield, Kern County, California.

The Industries of Japan.

Agriculture is the chief pursuit of the people of Japan, and in the greater part of the cultivated area rice and the principal food crops, wheat, barley and soya beans, are grown. Mulberry trees are planted everywhere. Tea is mainly cultivated in the south of Honshiu and in Taiwan, Formosa. The mineral wealth of the empire is great, but much improvement is needed in mining. The coal production is rapidly increasing, especially in Kinshiu and Hokkaido. The development of the iron industry is somewhat slow, but much is hoped for in the future. The production of silver has been steadily rising; copper and antimony are also among the principal exports of the country.

The industries of the Japanese empire may be distinguished as "original" and "imported." The original industries which existed from early times are those of ceramics, weaving, embroideries, lacquer work, paper, metals, leather, wood and bamboo, carvings, camphor, vegetable wax, salt, sugar, saké, soy, oil, tobacco, indigo and raw silk. These industries seem to have been first introduced from Corea or China, but the lapse of several hundred years has obliterated the original traces. Their scope of working is generally small, and the tools and instruments used are rude and simple. The industries which have been introduced into the country are those lately brought over from Europe and America. These comprise cotton spinning, brick making, preparation of drugs and chemicals, cement works, wire making, woolen manufacture, shipbuilding, and machinery; match, paper, and soap making. These industries are generally carried on on a large scale, employing a vast number of

workmen and using water and steam power. According to the latest returns, the total number of factories belonging to companies and individuals is 5,985, 1,098 of these being provided with steam engines, and 221 with both steam and hydraulic engines.—Journal of the Society of Arts.

Miscellaneous Notes and Receipts.

Dull Black Varnish for Metals.—Copper nitrate, 500 grammes; alcohol (90 degrees), 150 grammes. The copper nitrate is melted on the fire and then added to the alcohol. It is applied warm.

For Bleaching Copper Engravings which have turned yellow, peroxide of hydrogen, chlorine water and eau de javelle have been employed with good success. When using the last two remedies the copper prints have to be treated after the bleaching with a diluted solution of hyposulphite of soda to neutralize any traces of chlorine remaining in the paper.—Technische Mittheilungen für Malerei, December 1, 1897.

Self-luminant Color.—The many preparations that are luminous in the dark generally consist of calcium sulphide or barium sulphide. As regards their effect, they are much excelled by calcium tungstate, which is best prepared by heating in a Hessian crucible several hours to red heat 30 parts sodium chloride, 30 parts sodium tungstate and 30 parts calcium chloride, well mixed. The mass melts into a vitreous paste, which is bruised after cooling and breaking of the crucible and lixiviated in water, whereupon the fine crystals of calcium tungstate remain. These are fixed on the surfaces by applying a layer of glue on which the crystals are strewn.—D. Chem. Ztg.

New Process of Varnishing Wooden Ware.—According to the Neueste Erf. und Erf., the wooden objects to be varnished are first coated with a layer of pyroxyline, or a solution of the same in alcohol or any other volatile solvent, to which some resin varnish may be added, which body has the property not to penetrate into the wood and not to swell the wood fiber, but to leave the color of the wood unchanged. The absorption of the first coat of varnish and consequently a roughening of the surface being thus avoided, the polishing of the varnished surface after the first coat of varnish is obviated thereby. The resin varnish solution applied on the first layer may be covered by another coat of pyroxyline for protection, to which some resin varnish may likewise be added.

Shell Gold or Ormolu.—Ormolu (or en coquilles) is prepared in the following manner: A small, unglazed bowl is pressed full of kitchen salt and exposed for some time to the heat of a stove, covered up. The salt, after having given off its water in the heat, becomes very hard and is coarsely powdered. A small quantity of this salt powder is put with an equal volume of honey on a glass grinding plate; this is finely ground with gold leaf, thinly beaten, without pressing down hard. The salt acts mechanically as a disintegrating agent. Honey is used for moistening because the salt does not melt in it. When the gold is ground as finely as possible, it is carefully washed with plenty of pure water, until salt and honey are entirely removed. Alloys of gold become unsightly and dirty with this process, but washing with a little hydrochloric acid will remedy this.

Producing Reliefs by Electricity.—An electrolytic process to produce reliefs in steel has been invented and patented by Joseph Riedu, in Munich. This process is described as follows with regard to dies: An impression of the relief of a coin is made in plaster of Paris in such a manner as to form a column several centimeters in height. This column is insulated at the circumference by hard rubber and placed in a vessel with a suitable electrolyte so that the relief side is above, while the lower side reaches into the electrolytic liquid. In consequence of its great porosity, the gypsum absorbs the same until saturated. Now a piece of steel is placed upon the picture side of the gypsum column and the electrolyte is connected with the negative pole, the steel with the positive pole. The galleries of the steel which come into contact with the saturated gypsum are dissolved and by its own weight the piece of steel sinks down to the deepest galleries of the plaster model, which finishes the copy. Although the respective experiments are not yet closed, it may be asserted that not only steel but most of the other metals may be worked according to the above method. This electrogravure can, of course, also be employed for copying antique chased works of art, and will most likely soon be employed to produce counterfeits of antique articles of virtu which it will be difficult to distinguish from the originals.

Notice to Subscribers.

All new subscriptions to the SCIENTIFIC AMERICAN from this date will begin with the date of receipt instead of from the beginning of the year, unless the subscriber specifies otherwise.

CHANGE OF ADDRESS.—Subscribers may have the address of their paper changed as often as desired, but they will please send us both the old and the new address.

Science Notes.

Greenwich Observatory complains that it has little clear weather. Sun and stars are wholly invisible every other day in winter, one day in four in fall, one in eight in spring, and one in sixteen in summer. In the twenty years ending with 1896 there were only eight instances of sunlight for fourteen continuous hours.

Certain women in St. Petersburg, the wives of scientists, anticipating the visit to their city next summer of Dr. Nansen, have determined to make him a unique present. It will be a square of tapestry upon which will be embroidered a map of the polar regions, with the line of Nansen's march marked in gold thread.

The French town of Etampes has introduced an interesting novelty by replacing the recording secretary of the municipal council with a phonograph. Some of the members of the council objected to the innovation on account of the too great faithfulness of the apparatus in reproducing defective pronunciation and errors of speech, but the majority was in favor of making a trial.—Umland's Wochenschrift.

There was a hot time in Adelaide, Australia, on November 10, the temperature in the shade reaching 106° and in the sun 164°. The sky looked queer, the sun was blood red, and many people concluded that the world was coming to an end. At one public school the children were seized with a panic, which was stopped with difficulty by the head master, who later kept the whole school in till it had made up the time lost in the scare.

Senhor Bôrteux, of Rio de Janeiro, Brazil, has invented a new method by which photographs may be taken under water. The light is furnished by an incandescent lamp [placed in a steel case in the diver's headpiece. The luminous rays are projected by a reflector placed in the rear of the steel case. The electricity is provided by means of a small dynamo carried in the boat above. The photographic apparatus itself consists of a common camera placed within an India rubber envelope, the front of which is glass. The machine is regulated and pictures are taken by pressing buttons through the India rubber covering. Through experiments made in the Bay of Rio de Janeiro, it has been demonstrated that pictures can be taken under water, of objects at a distance of ten or twelve feet, as easily as they can be obtained above in the full light of day.

In view of the prominence attaching to the Yukon district recently, owing to the Klondike gold boom, a few particulars relating to the meteorological conditions under which mining has to be carried on in the latest "El Dorado" may be interesting. A winter weather record is given by Mr. E. W. Nelson in the National Geographic Magazine (November). The record was obtained in the autumn and winter of the years 1880-81 at a fur-trading station on the Upper Yukon, not far from Dawson City. It covers the period from the early autumn to the opening of navigation on the Upper Yukon in spring, and is of peculiar interest at present, as showing some of the meteorological conditions in the area which is now attracting world-wide attention. The Yukon froze over on November 2, and was covered with a practically unbroken sheet of ice for more than six months. The temperature sank steadily from the end of October, and in December the lowest temperature, -67 deg. Fah., was noted. The lowest temperatures reached in January, February and March were -41 deg., -58 deg. and 43 deg. respectively. In the last named month the effect of the returning sun became evident, the greatest range—88 deg.—being obtained during that month. Not until the middle of May, however, did the ice start on the river, and it was some weeks before the river was free.

Ancient Varieties of Dogs.

According to D. G. Brinton, in Science, the first domesticated mammal seems to have been the dog. In the Swiss Society of Natural History, last year, Prof. Studer read a paper on ancient European dogs. The oldest variety was the so-called peat dog. It belongs to the neolithic period. There were four other varieties known in the bronze period and in that of the lake dwellings. Direct descendants of these are the German hunting hounds, the shepherd dog and the poodle.

In America there is little evidence that any dog was trained for hunting. In the far north the Eskimo dog was a beast of draught, the only one known to the Red Race. The dogs of Mexico and Central America seem to have been principally raised for food or ceremonial sacrifices. In Peru there were several varieties under domestication, two of which have been clearly distinguished.

It is noteworthy that, although in many American tribes the dog was a sacred or mythical animal in the legends, he was not regarded with affection, but with dislike and aversion, a fact strongly brought out by Von Tschudi.

APPARATUS FOR MEASURING THE HEIGHTS REACHED BY BALLOONS.

For the measurement of the height reached by a balloon several methods have been proposed. One of these is to measure the diameter of the balloon, as seen from the earth, by means of a telescope, and another is to make observations from the extremities of a base of known length; but complicated methods such as these offer special difficulties and are generally replaced by the observation of a barometer placed in the car, while the temperature is carefully noted at the same time.

The formula employed for calculating the height of a balloon with these data is due to the illustrious Laplace. It has been modified by several physicists, and the results that it furnishes have been controlled by observations made upon mountains of which the heights have been measured by trigonometrical processes.

But such verifications, which scarcely exceed 4,500 meters, do not authorize the admission that the figures deduced from the formula will be exact again when applied to balloons that ascend to 17,000 meters, a height that they may perhaps exceed upon subsequent ascensions.

There is here an important question of general physics, and, in order to attempt the solution of it by direct experiment, I have devised and recently had constructed a photographic apparatus to be carried by the balloon, and which, at intervals of time determined in advance, photographs the ground over which it is passing and at the same time fixes upon a sensitized plate the image of an aneroid barometer arranged above a second objective.

This apparatus, which has been elaborated and constructed with the greatest care by M. Gaumont, the superintendent of the Comptoir General Photographique, consists of a wooden box (Fig. 3) suspended beneath the balloon. The ropes that support it unite at a carbine swivel fixed in a ring so as to keep its axis in a sensibly vertical position.

In the figure the apparatus is represented as closed and the button that sets the motive apparatus in operation is seen upon its vertical face. Upon the under side, which faces the earth, there is arranged an anastigmatic objective, O, diaphragmed to $f = 20$ (Figs. 1 and 2), the principal focus of which is 221 millimeters. Upon the opposite side there is placed a second objective of short focus designed for photographing the aneroid barometer, G, arranged at the proper distance for giving a sharp image upon the same negative.

A clockwork movement, J, in acting upon a bent lever, F, permits the shutters of the two objectives to open abruptly and allow the luminous rays to pass for a period not exceeding $\frac{1}{100}$ of a second.

The two luminous rays simultaneously make an impression upon a photographic film of sensitized celluloid, which, in passing from the magazine, C, winds around a cylinder, B, which is made to revolve by means of a spring contained in a barrel.

In passing from one cylinder to the other the sensitized film presses against a glass, P, so as to present a perfectly plane surface to the luminous rays.

The progressive motion of the film is produced by the action of the same motor, J, which, after freeing the shutters, permits the cylinder to revolve so as to wind over its surface that portion of the film that has been acted upon by the light.

In the center of the negative that reproduces the landscape is situated the image of the barometer.

With such negatives it is easy to determine the height of the balloon at the moment at which each of them was taken.

When we know (1) the focus of the object, (2) the distance of two points located upon the earth and (3) the distance of these two points upon the negative, it is possible, through a simple calculation of proportions, to determine the height of the balloon; and, since the

negative gives also an image of the barometer and consequently the pressure, it is possible to deduce therefrom, experimentally, the law that connects the barometric pressure of the atmosphere at various points with the altitude of the latter.

The possible error in the measurement of the altitude thus calculated will depend upon the accuracy of the measurement of the focus on the one hand and of that of the negative on the other, as well as upon an exact knowledge of the distance of the two points selected upon the earth. Now, it is easy to obtain such measurements with great precision.

Various precautions have been taken to assure the perfect operation of the apparatus. Thus, the movements that the strip of celluloid must undergo during its unwinding might modify its dimensions. In order to prevent any errors that might result from this, two parallel lines, the spacing of which is perfectly known, are engraved with a diamond upon the edges of the glass plate, P. The light, upon entering the apparatus at the moment at which the shutters act, photographs upon the film these lines as well as two others that are likewise parallel and at right angles with the first. If, after the development and drying of the negative, there is no perfect coincidence between the engraved lines

This apparatus was submitted to experiment for the first time on the 21st of last October in an ascension organized by the Commission d'Aerostation Française, for the purpose of testing various automatic apparatus designed for the exploration of the upper atmosphere.

The balloon used was one made of Chinese silk, of 1,700 cubic meters capacity, offered to the commission by M. Mascart on the part of M. Balaschaff. Moreover, Prince Roland Bonaparte was kind enough to defray all the expenses incurred on the occasion.

The balloon, which started from the Vilette Gas Works at 12h. 40m., descended at 4h. 26m. at Cossé-le-Vivien, department of Mayenne, after making its trip at a mean speed of 86 kilometers an hour. Despite extremely violent squalls, the start and descent of Messrs. Hermite and Besançon, the aeronauts, took place without accident, but the atmospheric conditions did not permit the balloon to ascend higher than 2,500 meters.

M. Violle's apparatus, which is designed for registering the solar radiation, worked perfectly, as did my photographic apparatus (just described), which, at intervals of from two to three minutes, took 13×18 negatives of extreme sharpness. Upon these latter, the houses, roads, railways and fields over which the balloon passed appear with all their details.

Thanks to the kind aid of the director of the geographical service of the army, I have been able to obtain a measurement of the negatives taken during the trip of the "Balaschaff," under conditions of great precision.

Such measurements were made by taking groups of two points situated sensibly upon the same horizontal plane, the distance of such points being about a thousand meters. For the determination of the distance upon the earth of the points selected, maps to a scale of 1-10,000 and 1-14,000 were used.

Fig. 4 gives a reproduction, on a reduced scale, of the sixth negative taken after the start. In the center is the image of the barometer that permits of easily reading the pressure.

The village of Elancourt, the houses of which are seen to the right, along with their gardens and walls, was photographed by the apparatus at a height of 2,250 meters. The various roads, which have very pronounced curves, stand out in white from the dark ground of the fields through which they pass. Elancourt is a village of 620 inhabitants, situated near Trappes, in the department of Seine-et-Oise.

The results obtained in this first trial ascension are therefore very encouraging, despite the insufficient height attained by the balloon.

In order to obtain great precision in the measurement of pressures, I am now having constructed an aneroid barometer which I have so arranged that the needle may make two entire revolutions

upon the dial. This instrument will give readings comprised between the pressure of the sea level, say 0.760 meter, and 0.08 meter, or together 680 millimeters. Now, since the dial of the barometer is divided into 400 parts, we shall have, for two revolutions of the needle, 800 dial divisions for representing the 680 millimeters of the travel of the apparatus. By means of the photographs that my apparatus thus improved will give, I hope to verify by direct experiment the measurements of altitudes furnished by the barometer in the highest regions of the atmosphere.—L. Cailletet, in *La Nature*.

OBSERVATIONS have been made recently to determine the extent and cause of the extraordinary deflection of the magnetic needle which takes place over a vast tract of Central Russia. The line selected for observation was one of about 850 miles between Moscow and Kharkov. The widest aberrations are found to exist in the province of Kursk, the capital of which is about 600 miles south of Moscow. In the southeast portion of this province, about 150 miles south of Tim, the needle is deflected more than 96 degrees, and points almost due east and west instead of north and south.

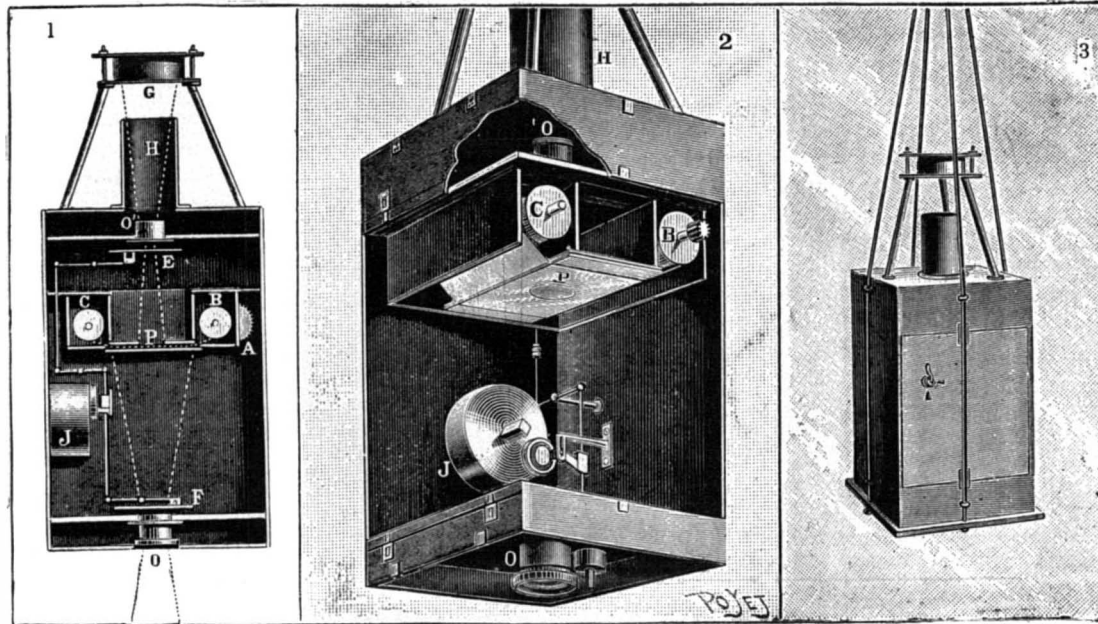

Figs. 1 and 2.—SECTIONS. Fig. 3—GENERAL VIEW.

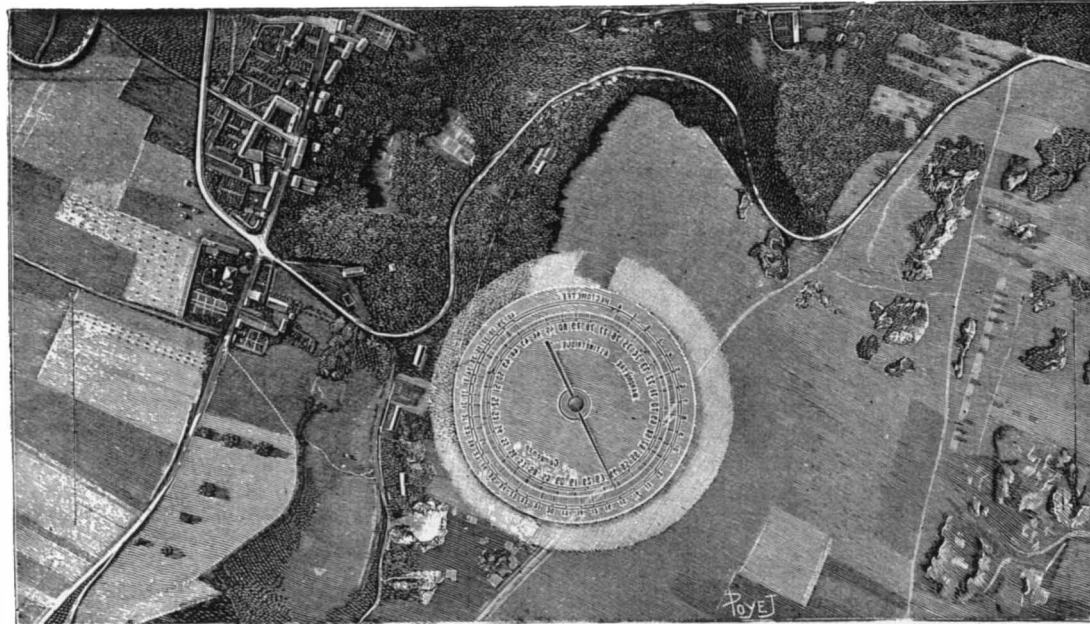

Fig. 4.—REDUCTION OF NEGATIVES OBTAINED WITH THE APPARATUS. CAILLETET'S AUTOMATIC PHOTOGRAPHIC APPARATUS.

and their image, the difference is measured and brought into the calculation.

When the apparatus is to ascend to great altitudes at which a temperature of at least -70° prevails (as we have ascertained), it is necessary to protect the mechanism and the barometer against the influence of such extreme temperatures, which would paralyze their motion. To this effect, we have arranged two tubes of thin copper filled with fused acetate of soda in the box of the apparatus previously protected by a covering of thick felt. The soda, in passing back to a crystalline state, disengages a quantity of heat sufficient to assure the regular operation of the motor.

The barometer, G, is fixed above the sunshade, H, opposite the short focus objective, O, arranged at the upper part of the box, which care has been taken to paint white in order that it may be adequately illuminated.

A copper receptacle of the same form as the barometer (and not represented in the figure) contains fused acetate of soda, which, by its contact, prevents the barometer from ceasing operation under the influence of the cold.

RECONSTRUCTION OF THE DISMAL SWAMP CANAL.

The dividing line between the States of Virginia and North Carolina intercepts at its eastern extremity a vast morass or swamp, which extends from near the town of Norfolk in the north toward Albemarle Sound in the south, a distance of forty miles. In an east and west direction it measures some twenty-five miles. The soil of the swamp is made up largely of black vegetable matter, often saturated with water and during a large part of the year covered in places with stagnant pools. The greater part of the swamp is covered with a dense growth of timber, in which is found the cypress, juniper and cedar, with beech and oak upon the higher ridges. In the center is Lake Drummond, a body of fresh water measuring about five square miles in area and having a depth of about ten feet.

It will be seen from the accompanying map (Fig. 5) that two rivers of considerable size flow from the swamp to deep water; Elizabeth River flowing north and discharging into Hampton Roads and the Pasquotank River flowing south into Albemarle Sound. The intervening distance across the swamp between the navigable points on these rivers is about twenty-five miles, and it is evident that the situation is such as would naturally suggest the construction of a canal to connect such important bodies of water as Chesapeake Bay and Hampton Roads with Albemarle Sound.

The old Dismal Swamp Canal was built with the assistance of the national government and the State of Virginia, and as far as its limited capacity would allow, it has served as an outlet for the timber and for a certain amount of the agricultural produce of the eastern districts of North Carolina. It extended from Elizabeth River, at a point a few miles south of Norfolk, to the Pasquotank River, and covered a distance of 29.10 miles. The first section of the canal from Gilmerton Locks to Deep Creek Lock was 2.75 miles in length, the level being 5.93 feet above low water in the Elizabeth River. The next section extended from Deep Creek Lock to Northwest Lock, was 9.75 miles long and had a level of 16.20 feet. From Northwest Lock to Culpeper Lock, 8.79 miles was the summit level, 19.73 feet above Elizabeth River low water. The South Level, 3.61 miles in length, terminated at South Locks, where the canal was continued at tide level through Turner's Cut, a distance of 4.21 miles, to the Pasquotank River.

This description and the accompanying profile show the condition of the canal when the present improvements were started. The original canal only connected the waters of Deep Creek, a tributary of the Elizabeth River, with Joyce Creek, a tributary of the Pasquotank River, and was but 22.15 miles in length. The Gilmerton Level and Turner's Cut were added at a later date. This canal followed the course of a former lumber ditch which owed its inception to the wants of the early settlers upon Deep Creek and the

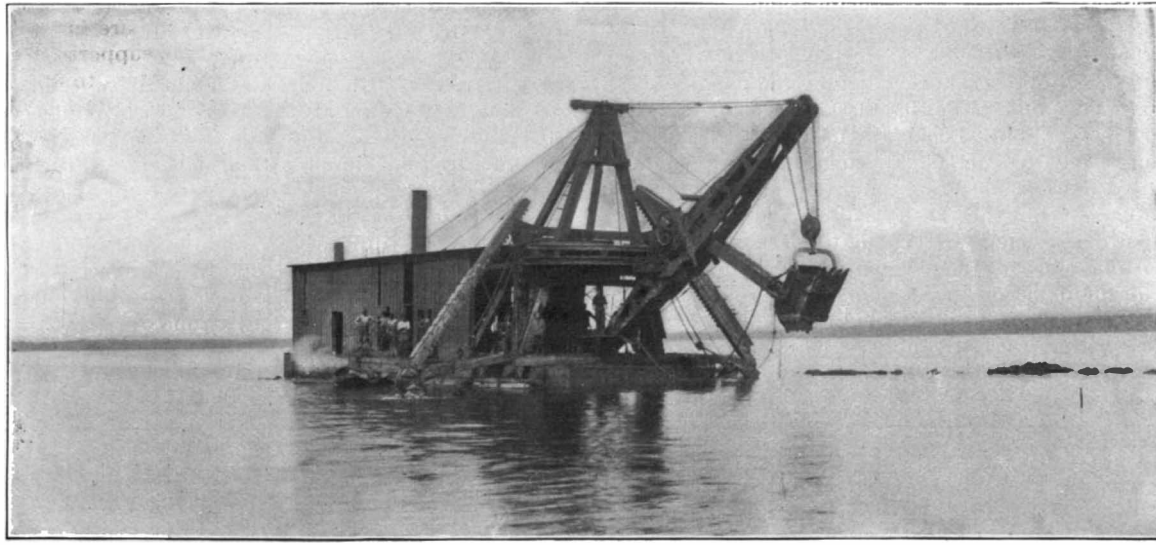

Fig. 1.—DREDGING ENTRANCE TO FEEDER CANAL, LAKE DRUMMOND.

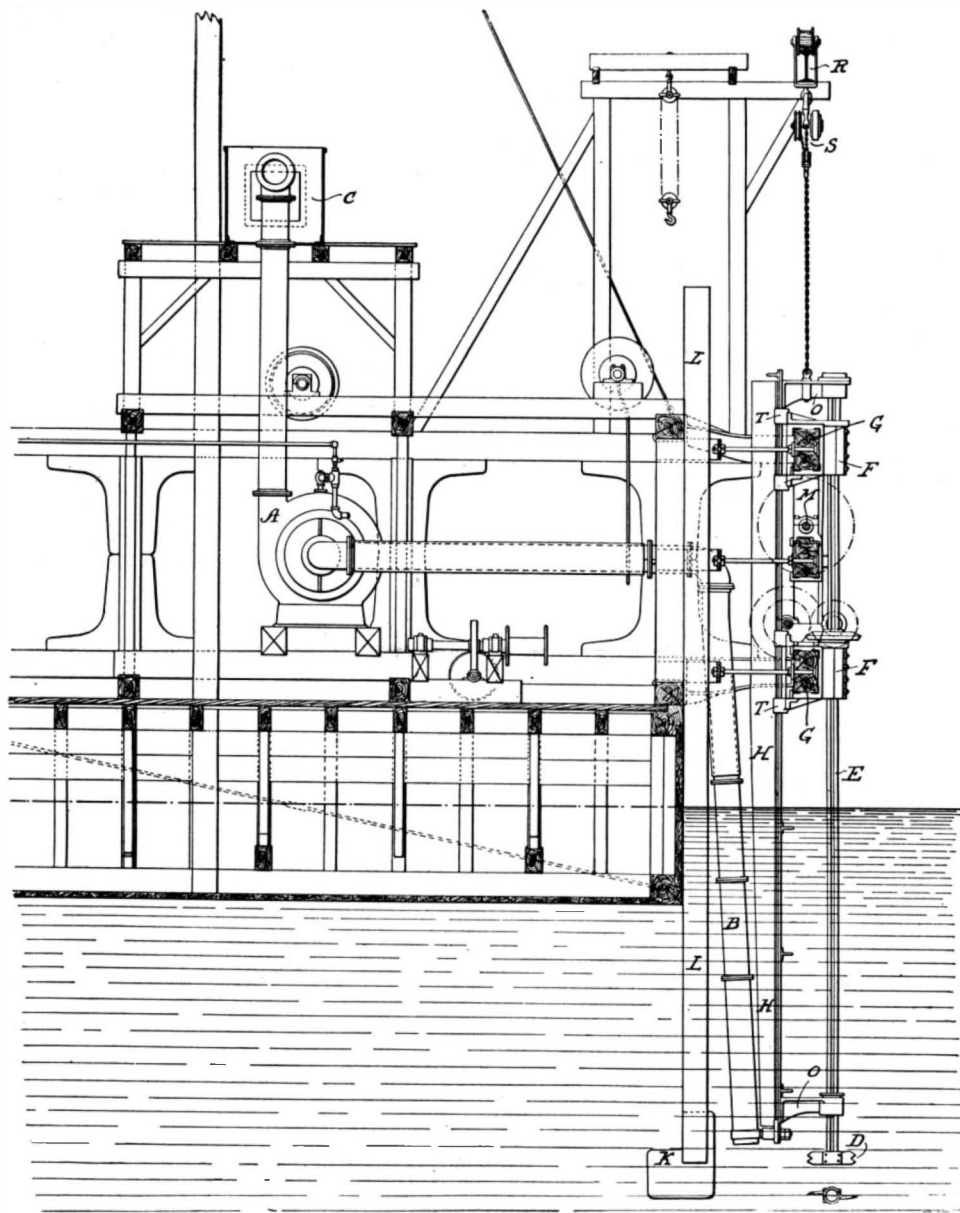

Fig. 2.—SECTION THROUGH FRONT END OF HYDRAULIC DREDGE.

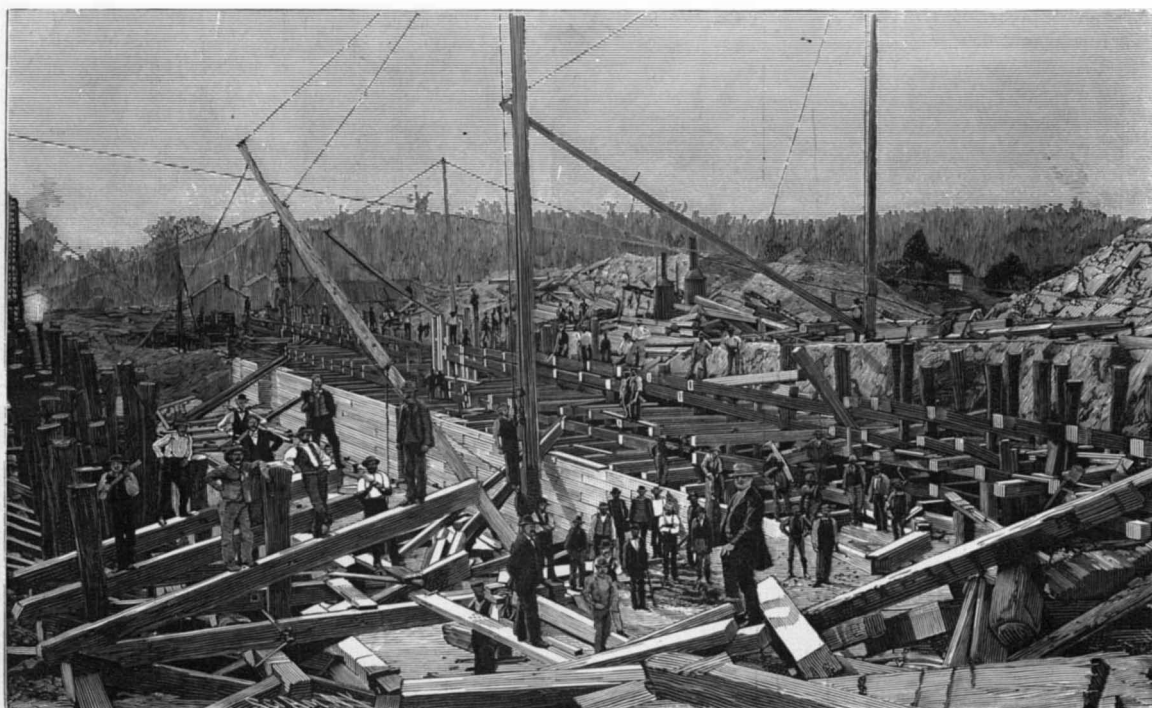

Fig. 3.—CONSTRUCTION OF LOCKS, DISMAL SWAMP CANAL.

Pasquotank Rivers, who built separate ditches from the neighborhood of Lake Drummond to float out the timber. These were eventually joined and developed into the present canal, and it is these circumstances that account for the angle in the canal where it passes the lake. Water for the supply of the canal was taken from the lake by a feeder at the Summit Level, 3.46 miles in length.

Although the old canal was supposed to provide a depth of six feet throughout, its available depth was scarcely half that amount. The level varied with the rainfall, and the bottom of the canal was so obstructed with sandbars and accumulations of wreckage—sunken logs from timber rafts, etc.—that boats having a draught of more than two or three feet were unable to pass through. The report of a government survey made by Assistant Engineer Frederick W. Post, in 1880, speaks of Deep Creek Level and Turner's Cut as "constituting the worst features of the work, having been constructed through low sand ridges, and the high banks formed from the excavated material being left without protection of any kind." The sand had fallen or drifted back into the canal, forming sandbars which extended more than half way across the cut. A study of the accompanying profile shows the irregularity of the bottom, especially at Turner's Cut. The canal also suffered during the war, and its final practical abandonment was caused by the construction of the Albemarle and Chesapeake Canal, which accommodates boats of a greater tonnage. The report referred to states that the canal was not at that time navigable by a boat of more than 3½ feet draught or whose beam was over 16½ feet, or its length greater than 108 feet.

Another survey made by the same engineer in 1896 found the canal in such a condition that boats drawing over two feet of water were unable to pass through. Fresh shoals had formed in several places, and the losses due to percolation and the prevalence of an unusually dry season had brought navigation practically to a standstill, the weekly traffic amounting to three or four lighters and an occasional raft of lumber.

The plan of improvement recommended in 1896 was practically the same as that of 1880, and contemplated abolishing the Northwest Lock at Wallaceon and the formation of a summit level extending from Deep Creek to Culpeper Locks, at an elevation of 16.20 feet above mean low water in the southern branch of Elizabeth River. The South Level length was to be lowered 3 feet and Gilmerton and Turner's Cut were to be maintained at their present location and elevation. Four masonry locks were to be built, one each at Gilmerton, Deep Creek, Culpeper and South Mills, each lock being 40 feet by 220 feet. The canal was to be 10 feet deep and 80 feet on the bottom, with slopes of 1 to 1 and 1½ to 1, according to the material of excavation. The estimated cost of this work was \$1,711,380.

The present reconstruction

tion of the canal is being carried out under Mr. J. C. Wrenshail, the chief engineer of the Lake Drummond Canal and Water Company. The government plans have been modified by abolishing the Culpeper Lock, as well as that at Wallaceton, and forming one level, 22 1/2 miles in length, from Deep Creek to South Locks. New timber locks are being constructed at each end, the chambers being 40 feet in width by 125 feet long. The depth throughout is to be 10 feet; but the width is reduced from 80 feet on the bottom, as suggested in the government report, to a bottom width of 40 feet and a surface width of 60 feet or more, according to the slope allowable by the nature of the material.

The new level will be 7 1/2 feet lower than the old summit level—a change which will present a twofold advantage: It will serve to drain a large area of cultivatable and cultivated land in the swamp and, because of the increased drainage, it will increase the water supply for compensating the losses through lockage. It is expected that the drainage of the adjacent lands will be a benefit second only to that conferred by the improved navigation of the canal. The Gilmerston Level and Turner's Cut will be abandoned and the locks will discharge directly into the rivers at each end of the canal. The feeder canal from Lake Drummond has been deepened and widened, and at about 200 yards from the shore of the lake a new lock 20 feet wide by 100 feet long has been completed. The contractor for the deepening of the canal is P. McManus, of Philadelphia, to whom we are indebted for several views showing the special plant employed in carrying out the work. Others of our views were furnished by Mr. G. B. Overton, of South Mills, who has also furnished us with useful data regarding this interesting project.

The conditions at the letting of the contract were such that the contractors were obliged to build an entire dredging plant in the middle of the canal, the difficulties of transportation being such as to render it impossible to bring the plant to the work in bulk. Selecting a position on the old Summit level, not far from Lake Drummond as a starting point, Mr. McManus built four large hydraulic dredges and three dipper dredges. It was necessary to build these boats in the middle of the canal, moreover, as a provision against a season of drought, and the plan proved afterward to be correct, since for a period of three months during last summer the old canal was entirely drained, and the only water available to float the dredges was what remained in the portion which had already been dug. Our two illustrations show the method adopted in the work of widening and deepening. The dipper dredges first removed the surface material, tearing up roots and matted vegetable growth to a depth of about 5 feet. Behind these followed the hydraulic dredges, which worked upon the looser material underlying the bed of the canal. The nature of the material to be excavated varied, but consisted chiefly of hard clay mixed with sand. The deepest excavation was, of course, in the old Summit level, where it extended to a depth of 17 1/2 feet below the normal surface of the water. It is interesting to note that at this depth a large number of fossils and oyster shells, together with coral and other calcareous matter, were brought up by the dredges. The specimens belong to a deposit of the Miocene age, and include oyster shells weighing as much as 5 pounds apiece and fully 12 inches in length. The level of the water in the finished canal will be 7 1/2 feet below the old level, and the Deep Creek level will be similarly lowered about 4 feet, making a continuous level, as before stated, from Deep Creek to the South Mills, a distance of 22 1/2 miles. The total yardage to be moved is estimated to be about 3,600,000 cubic yards, and the total cost of the improvement, completed, is estimated at about \$1,000,000.

Our illustrations show the general construction of the two systems of dredges employed. The dipper dredge has a 2 yard bucket and 60-foot boom; its capacity varies between 1,000 and 1,800 cubic yards per ten hours, according to the nature of the material which it is handling. The illustration, Fig. 1, shows another dipper dredge of about the same capacity at work in Lake Drummond. This machine is provided with "land spuds." These were rendered necessary, because the specifications required that the present width of the feeder should be maintained; consequently, the width of the boat was limited to 20 feet to enable it to pass through the lock at the lake and, to give it sufficient buoyancy and prevent it from capsizing, the lateral "spuds" had to be employed. The construction of the hydraulic dredge, which, under favorable circumstances, can remove about 2,500 cubic yards in ten hours, is shown in our front page engraving and the

smaller line engraving. Although its capacity under ordinary circumstances is 2,500 yards, the obstructions in the way of floating debris which were met with when digging the canal have limited its capacity to about 1,000 cubic yards per day. The dredge is manipulated by means of side lines and head lines, the head lines being worked by pulley drums and friction clutches and the side lines by winches operated by hand. There is also a spud at the rear to keep the boat from traveling too fast, which is kept down continuously upon the bottom. The shafts and pumps are all run by a 100 horse power engine, which is belted to the cutting shaft and to the pumps. The vertical cutting shafts, E, Fig. 2, of which there are two, are capable of both vertical and horizontal motion. They give a cut 24 feet wide

The walls are built up of the same size material, and they are supported by three rows of piling driven on 8-foot centers, to which they are braced with horizontal and inclined 12 x 12 inch struts.

Work was commenced February 15, 1896, and it is expected that the new canal will be ready for operation some time during the summer of the present year.

Petrified Forest Protection.

Land Commissioner Hermann is at work on a special report to the Secretary of the Interior, recommending that a forest reserve be made out of the petrified forest of Arizona.

Recent reports received by the Interior Department about the condition of this forest indicate that it is

rapidly being used up for commercial purposes, and, unless the government steps in to stop the despoilment, the whole forest, which is one of the greatest natural curiosities in the world, will disappear. There is now building in Denver a hotel, all the walls of which are to be faced with the silicified wood taken from the forest, and all the tables for the hotel are also to be made of it. At this rate of consumption it would

not be long before all the petrified wood would be used up. Commissioner Hermann thinks that there is immediate necessity for action on the part of the department. In his opinion, the best way in which the forest can be preserved is to make it a forest reserve.

The forest is located near Holbrook, in Apache County, Ariz. The largest and finest specimens of silicified wood in the world are taken from it. Whole trunks of trees and stumps with portions of the roots are found there, converted into stone as dense and hard as the finest agate. Every cell and every fiber of the former wood is preserved in stone. A forest of trees appears to have been entombed in the rocks and to have been preserved by a slow process of replacement by silica from solutions premeating the bed. Subsequently the surrounding sediments were washed away, but the enduring fossils of the trees remained.

Tons upon tons of specimens have been taken away by collectors and dealers. A company has been formed in South Dakota for cutting and polishing the stone for architectural and decorative work. Sections of these trees, four feet in diameter and large enough for the tops of tables, have been cut and polished. Many specimens were shown at the Paris Exposition, where they were greatly admired for the perfect preservation of every detail of structure of the wood, for the very high polish, and for the exquisite interblending of colors in the mass, due to the presence of various oxides in the original silicifying solutions. No other country in the world, it is claimed, can send to the lapidary such magnificent raw material of this nature as the petrified forests of Arizona afford. Not even the imperial works at Ekaterinburg, in Russia, with their wealth of kalkansto jasper, massive malachite, and other superb ornamental stones, can rival the beauty of the agatized wood of Arizona.

Commissioner Hermann is confident that Secretary Bliss will agree with him, when the facts are brought to his attention, of the wisdom of making some provision to protect this wonderful curiosity from despoilment.

Movement of Fishes' Eyes.

M. Nishikawa, in the current number of the Japan Zoological Annotations, describes a newly discovered mode by which the eye of the lower side of a flat fish travels round to the upper side during metamorphosis. According to the observations of Agassiz, the eye of the eventually blind side of the majority of flat fishes travels round the dorsal edge of the head until it attains its final position, and it is not until the rotation is completed that the dorsal fin grows forward beyond the level of the eyes. An exception in this respect is *Plagusia*, in which the dorsal fin grows forward to the snout, while the eyes are still symmetrical, and the left eye attains its final position on the left side of the fin by penetrating through the soft tissues at the base of the fin. In the fish observed by M. Nishikawa the dorsal fin also grows forward before the rotation of the right eye; but this anterior extension does not unite with the head until after the rotation is completed. Its neutral margin is contiguous with the dorsal surface of the head posteriorly where there is a distinct hole, bounded by the head and the anterior extension of the fin, for the passage of the right eye, which travels round the dorsal side of the head without sinking into its tissues. It is thus clear that the mode by which the change is effected in this fish is intermediate between that observed in ordinary flat fishes and that which is exhibited by *Plagusia*.

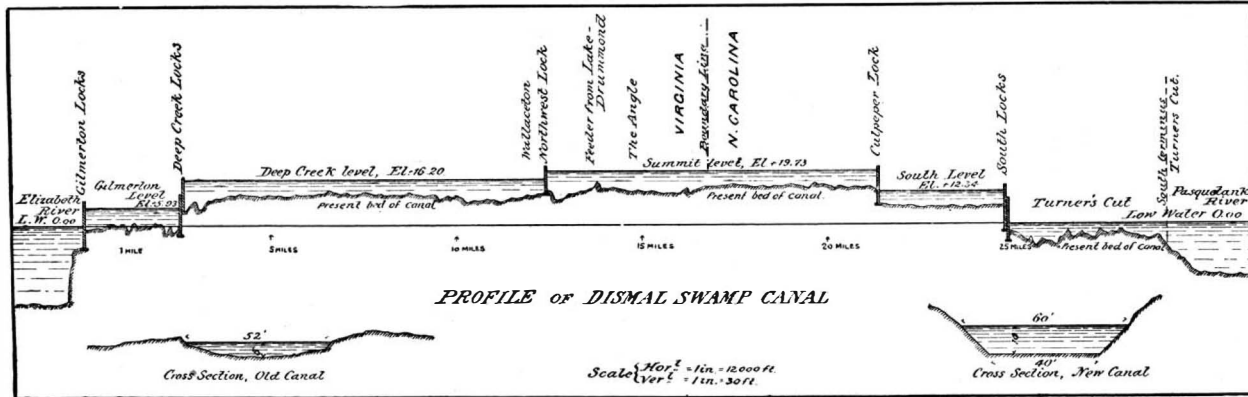

Fig. 4.—PROFILE OF THE OLD CANAL.

and as deep as the knives will go, or 18 feet. Each shaft carries about fifty knife arms on it, and as the dredge is drawn forward against the cut these revolve toward each other and cut loose the material. The shafts, E, are carried by brackets, O, which extend forward from a stout wooden frame, H. This frame is hoisted by chain and pulleys, S, which are suspended from a traveling carriage running upon an I-beam, R. The knives and frame are themselves carried and slide vertically in a strong double Y-frame or yoke, F F, clearly shown in the front view of the dredge, and the Y-frame slides horizontally on heavy transverse timbers, G G, which extend across the front end of the boat. The travel of the knife shafts in the Y-frame and of the Y-frame on the transverse timbers thus gives the cutting

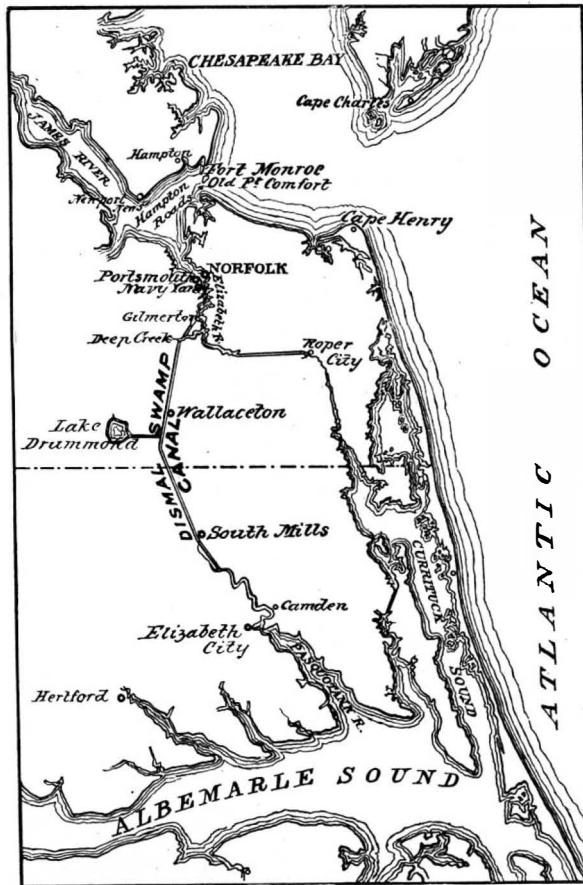

Fig. 5.—LOCATION OF DISMAL SWAMP CANAL.

knives a play over a cut 18 feet deep by 24 feet wide. The Y-frame is moved by a loose worm, M, on the center horizontal shaft, and the proper rotary motion is transmitted from the lower horizontal shaft to the cutting shafts by loose bevel gears.

The mouths of the suction pipes are placed behind the cutting knives, and the loose material and water are drawn up and discharged into a transverse trough, C, which is located about 18 feet above the surface of the water. The material is then discharged by gravity at points 60 feet distant from the canal on either side.

Our illustration (Fig. 3) shows very clearly the construction of one of the locks. The floor is carried upon piles which are driven on 4-foot centers to a depth of from 15 to 25 feet. These are capped with 12 x 12 timbers laid transversely to the axis of the lock, and upon these is the solid floor of 12 x 12 sticks,

A HORNED COCKEREL.

BY EDWIN G. DEXTER.

Nature not infrequently makes serious mistakes in her handiwork, and although the dime museum managers and proprietors of catchpenny shows may be the greatest gainers, financially, by her misfits, a careful study of the monstrosities which occasionally appear in the animal kingdom is not without interest, even to the scientist. Although we might rightly question the value of any considerable number of such abnormalities in a synoptic collection of natural history specimens, they certainly have their legitimate place in any patho-



A HORNED COCKEREL.

logical museum, and their study throws some little light upon problems in embryology and heredity.

The monstrosities which have been observed in organic nature may, for the most part, be classified as cases of first dichotomy, second atavism, third vestigial parts. In the first class are included all cases of double or multiple parts, when a study of the ancestry of the animal shows that such supernumerary parts were never present in its phylogenetic evolution; such, for example, as two headed calves, dogs, snakes, and fish—not very uncommon monstrosities—four-legged chick-

ens and six or eight legged quadrupeds; in fact, nearly all cases in which normal appendages are reduplicated. Bandleben has, however, attempted to show that the ancestors of the modern mammals were heptadactyle, and that a single supernumerary digit should be put in our second class, but this has not been well proved.

Cases of atavism are those in which characteristics of some far-back ancestral form suddenly make their appearance. Such monstrosities are usually not so strikingly abnormal in appearance as are those of dichotomy, but are probably more common. Among them are cases of supernumerary mammae, ribs and vertebrae in the higher mammalia, one or more stripes resembling those of the zebra around the body of an ungulate, an unusual amount of hair upon any part of the human body and many secondary sexual peculiarities in the vertebrates.

As vestigial parts we must consider those peculiarities in organic structure which are being eliminated by the species in its evolution, though the structure normally pertains in a rudimentary form, usually abortive or useless, although Mr. Wallace remarks that "much that we suppose to be useless is due to our ignorance."

In this class of structures come the posterior appendages of the python, the cervical auricles of many mammalia, the vermiform appendix and muscles like the attollens aurem in man and the occasional pinnae of certain species of seal and of the whale.

Darwin calls attention to the fact that these rudimentary structures are extremely variable and are occasionally of such size as to form a true monstrosity.

The cock shown in the accompanying picture belongs to none of these classes, for the phylogeny of the class aves shows no ancestors which ever bore spurs or horns upon the head, nor are the parts supernumerary, since there is no vestige of spurs upon the tarsi. It is a true "sport" of a most unusual character, since rarely, if ever, have there been observed animals in which a normal part was found in an abnormal position. The spurs are symmetrically placed upon the sides of the head directly above the eyes and have every appearance of horns. They are of the usual size ($\frac{1}{8}$ inch long), the right one but slightly curved, though its mate is in the form of a nearly complete circle, with its point in contact with the skin at the base of the comb. They are attached only to the skin and easily movable in all directions, though this looseness of attachment may be only accidental.

I have under observation the offspring of this peculiar cock, in the hope that the variation may, in some cases, be transmitted.

A DEVICE FOR FASTENING NUTS.

In all machines submitted to vibration, the nuts have a tendency to become loose, and an endeavor has been made to remedy the trouble by means of various arrangements, the best known of which is the jam nut. But the jam nut is not always efficacious and does not give absolute security. In the device represented herewith the nut and bolt are rendered interdependent by means of a piece of steel with three branches, the central one of which engages in a polygonal cavity,

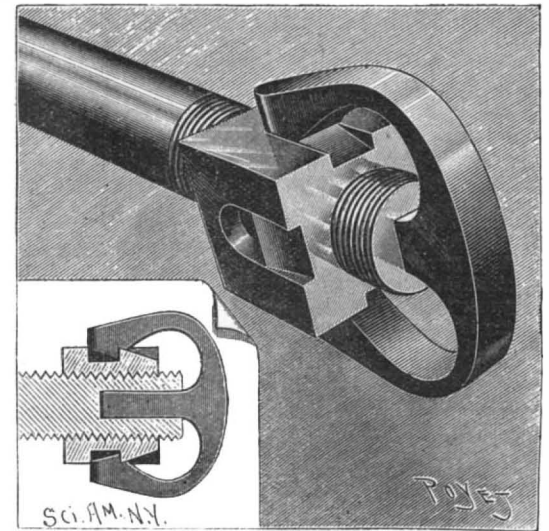

DEVICE TO PREVENT THE UNSCREWING OF NUTS.

formed in the head of the bolt, while the others engage in notches in the sides of the nut. The form of these notches is such that the lateral branches have to spread slightly in order to enter them, and the steel piece, once engaged, can free itself only by exerting a lateral thrust upon the two external branches at once.

This arrangement, devised by Mr. John Hartman, is, we think, capable of being utilized in the construction of automobile vehicles for firmly fixing the parts the eventual unscrewing of which might be attended with danger.—La Nature.

RECENTLY PATENTED INVENTIONS.

Railway Appliances.

BURGLAR PROOF EXPRESS CAR.—Orlando J. Foster, Silver Lake, Wis. A car designed to be effectually defended by a single person is provided by this invention, the construction being such that a person entering the car may be held a prisoner outside of the compartment in which the valuables are held. The car is divided into compartments by a partition in which is a revolvable door made in semi-cylindrical sections, there being means for independently operating each section, whereby the passage from one compartment to the other may be effected only at the will of the occupant of one of the compartments, and without the possibility of a second person also gaining access when following the one intentionally admitted. The improvement may also be put in use in banks and other places where valuables are kept.

HAND CAR AND MOWING MACHINE.—John L. Smith, Sumner, Neb. To facilitate cutting grass or weeds along the sides of the track rails, a hand car, according to this invention, is provided with a cutting or mowing attachment adapted to yield vertically to ride over obstructions, the attachment being readily removable from the car, enabling the latter to be used in the ordinary way. The car platform is carried by front and rear wheels, its driving mechanism comprising a gear operated by hand levers, a cutter bar shaft being located on an intermediate gear, and there being a vertically movable frame having forwardly projected teeth in which the cutter bar reciprocates.

Bicycles, Etc.

BICYCLE DRIVING GEAR.—William F. Williams, London, Eng. This invention relates to chain gear in which the ratio of the gear during the revolution is so varied by means of an elliptic sprocket wheel that the effective leverage of the pedals is decreased at the dead points and increased at the points where power may be most advantageously employed, the object being to maintain constant the tension of the chain notwithstanding the varying effective ratio of the driving and driven sprocket wheels.

BICYCLE GEAR.—Rudolph Whitman and Orris C. Abbott, Walkerville, Mont. To increase or diminish the leverage that may be exerted on a wheel, according to this invention, a gear wheel is mounted on a stub axle projected outward from the frame, and having an annular recess running around the axle, in which a wheel is revolvably mounted, there being a clutch ball interposed between the two wheels, while a guide plate is rigidly held by the bicycle frame and the stub axle, and the pedal lever has parts slidably connected with the second wheel and the guide plate.

TIRE TAPE.—Julius J. Stenger and Henry A. Rohm, Sayville, N. Y. A tape that is designed to afford good service when applied on the wheel is provided by this invention, the tape having a coating of vulcanized rubber or similar material on its outer surface, there being a layer of adhesive material on the other side. The tape is to be wound spirally about the tire in the usual manner, a vulcanized portion of the tape always overlapping a narrow unvulcanized portion.

Mechanical.

PIPE WRENCH.—Thomas Forstner, New Ulm, Minn. To facilitate conveniently adjusting the movable jaw close to the work and then locking it securely in place is the object of this invention, which consists principally of a jaw casing carrying the movable jaw, fitted to slide on the fixed jaw handle, and a dog adapted to engage the handle and carried by the casing, the dog being adapted to be locked to the handle to hold the casing in place. The construction is arranged to permit of quickly and conveniently adjusting the casing and the movable jaw close to the work and then to lock it securely in place, the wrench being of simple and durable construction.

COMBINATION TOOL.—Morrill H. Poor, San Antonio, Texas. A clamp, vise, brace, drill stock or wrench may be made of the tool provided by this invention, which is of simple and inexpensive construction and readily adaptable to the various uses contemplated. It has a body arm to which is pivoted a body bar having at one side a point and at the opposite side a vise jaw, while a second arm is adjustable to and from the first arm and is likewise adjustable on the body bar, the second arm being provided with a split jaw at one side and a vise jaw at the opposite side. As a brace or drill stock, the tool may be brought into use in places where the ordinary brace or drill stock could not be used.

ATTACHMENT FOR SQUARES.—George M. Elliott, Winnipeg, Canada. A bar formed with a slot for the passage of the square, according to this invention, is adapted to be clamped to the arms of the square, each clamp having a clamping screw engaging a transverse slot formed longitudinally in the bar, whereby the operator is enabled to conveniently and rapidly draw square, bevel and oblique lines in any conceivable position, the attachment being simple, durable and readily applied to the square. The device is designed to be especially serviceable to carpenters, bridge builders and other mechanics.

Agricultural.

CULTIVATOR AND HARROW.—Nathan P. Cook and William A. Whitfield, Monroe, La. This invention provides a harrow or cultivator frame which may be readily converted from a V or an A harrow or cultivator to a side cultivator or harrow frame, either right or left hand. The body portion of the frame consists practically of but two parts, means being provided for the attachment thereto of a clevis and the handles, and means for connecting the blades, teeth or shovels. The change from one form of harrow or cultivator to another may be readily made by the farmer, and the frame held as securely in one position as the other, all the binding and connecting devices being applied in the same manner in different forms of the machine.

CHURN.—Robert F. Yancey, Akard, Mo. This invention is for a churn in which the dasher may be revolved in opposite directions, and the dashers and shafts on which they are mounted may be conveniently and quickly cleaned. A frame sidable in uprights carries a hanger in which is journaled a shaft with beveled pinion, a tubular shaft turning around the

first shaft carrying also a beveled pinion, and both pinions engaging a driving gear, while a dasher is attached to each shaft, the opposing ends of the blades or paddles of the dashers being beveled, and the ends of the upper dasher blades being inclined to pass close to the upper surfaces of the lower dasher blades.

LAWN MOWER.—Perry G. White, Cedar Rapids, Ia. This mower is especially adapted to facilitate the adjustment of the cutters to cut grass at various lengths, the adjustment being made from the handle of the mower, and the mower being so placed that it will be flexible, adapting itself to the surface of a terrace or embankment, and cutting the grass thereon as evenly as on a level surface. Connected gear casings are rigidly mounted on the ends of the axle of the ground wheels, the casings carrying the cutting mechanism, while a spring-pressed bolt carried by the handle engages a rack on the axle, forming a flexible connection between the body of the lawn mower and its handle.

CROSS CLEVIS.—John L. Thomas, Osceola, Mo. This is a device arranged for convenient attachment to the clevis jaws of a plow beam, and adapted to be readily adjusted to any kind of a plow. It consists principally of a clevis body in which the clevis pin is removably held, while an arm adjustable on the clevis body is formed with a fork for receiving the clevis pin and one of the jaws of the plow beam.

Miscellaneous.

APPARATUS FOR TREATING GARBAGE.—Charles Edgerton, Philadelphia, Pa. This apparatus comprises a series of digesters having valved outlets, an endless metal slatted belt with rigid transverse pieces for receiving the cooked garbage, horizontal guides supporting the edges of the belt, and a series of pressing rollers continuously separating the solid from the liquid matters, the material being first cooked by steam and then subjected to pressure to separate the oils, the oils to be used for soap making and other purposes and the solid matter or tankage for fertilizers. In combination with the digesters and their discharging devices is a continuous roller press whereby the operation is rendered cleanly, rapid and sanitary.

CHAIN LINK.—William H. Griffith, New York City. Two patents have been granted this inventor for bent wire links, in which the greatest possible strength is combined with the most secure and unobtrusive manner of knotting or securing the ends, the invention thus securing strength and durability with compactness and symmetry. These links are of the pattern known as the "Figure 8" link, the opposite sides and ends of which are alike. The links are each made of a single piece of wire, whose ends are sunken into recesses formed by the various folds at the middle, the links being thus compactly knotted and not liable to catch into or wear anything with which the chain comes in contact.

BURGLAR ALARM.—Frank Fenley, New Orleans, La. This is a portable device, for use by travelers, etc., adapted to be secured in a crevice between a door, transom or window and the casing, in such

manner as to cause an explosion when the door or window is opened. It comprises a body having a cap-holding socket and a spring clamp, there being a spring-actuated exploding hammer pivotally held in the body and formed with a locking lip, one of the members of the spring clamp engaging the locking lip to hold the hammer raised. The device is readily carried in the pocket and easily applied to a door or window, etc.

CHECK PUNCH.—George O. Brosnahan, Jr., Pensacola, Fla. For conveniently punching the amount of a check, both in letters and numerals, to prevent fraudulently raising the amount, this punch is made with a sliding carriage carrying a set of perforating letter dies and a set of perforating numeral dies, there being means for shifting the carriage and a slidable anvil adapted to engage the corresponding dies of either set of dies, the anvil being shiftable from one set of dies to the other.

TICKET COLLECTING APPARATUS.—Joseph Antomarchi, Gloster, Miss. To facilitate the collection of tickets from persons entering a hall, theater, etc., or boarding a railway train, this invention provides a rotary gate with ratchet wheel engaged by a pawl, with which is connected a lever operated by a cam plate, in connection with a sliding plate, while a second sliding plate may be connected with the first sliding plate by a ticket, the connection between the plates and the retraction of the pawl, whereby only one may be allowed to enter, being impossible to effect only by the use of a ticket.

CANDELABRUM.—Herman F. Nehr, Brooklyn, N. Y. To so construct a candelabrum that it will be light, durable and inexpensive, and so that the arms may be adjusted vertically or laterally at various points in their length, are among the principal objects of this invention, enabling the arms to be given a great variety of shapes. Means are provided whereby each arm may be independently adjusted, and whereby also the arms may be made up of a series of sections, each section being capable of independent adjustment.

SASH ROLLER.—George E. Schmitt, Wellsburg, West Va. This invention provides a compact structure of roller and casing, whereby a set of rollers may be readily attached to a window sash to prevent rattling or the window getting tight, while it will always be dustproof and waterproof, as the sash is held closely against the outer strip at all times. The attachment is substantial, practical and durable, and is designed to work equally well under any slight expansion or contraction of the casing of the window frame. It is designed to be readily placed on old as well as new windows, and permits of the convenient removal of the sash when the windows are to be cleaned.

ORGAN ACTION.—Joseph Slawik, Bloomfield, N. J. To insure a positive and quick closing and opening of the valve for the sounding device is the object of this invention, an exhaust controlled by the key being connected with one side of the valve and a wind chest connected with the other side, so that on pressing a key the air is exhausted from one side of the valve, and the preponderance of pressure on the other side from the wind chest causes the valve to open to allow the air to pass to the sounding device, there being

an adjustable stop to limit the movement of the diaphragm valve.

SASH HOLDER.—Lewis H. Bowman, Walla Walla, Wash. To hold a window sash, without rattling, at any height desired, and to prevent the ingress of air or dust when the sash is closed, are the main objects of this invention, the device serving also as a lock to prevent raising the window from the outside. The device comprises a frame fitting against the sash within the window casing, the frame being swung away from the sash by links, while the frame may be swung tight against the sash by a pivoted cam lever and link.

WAGON AXLE BEARING.—Henry M. Cromer, Anderson, S. C. This invention is designed to facilitate the utilization of old thimble skeins, making them fit closely upon the axle, as well as provide a new construction, which consists of a conical sleeve attached to each end of the spindle bearing and adjustable in either direction, by which the spindle may be made to simply fit the sleeve at all times, and by which the position of the hub upon the axle may be adjusted to keep the tread of the wagon constant.

CLINICAL THERMOMETER SHIELD.—Jennie C. Harrington, Ossiian, Ia. This shield is especially designed for use on fever thermometers, to prevent patients from breaking the instrument while it is being held in the mouth. It consists of a casing, preferably of a suitable metal, such as aluminum or silver, made in two longitudinal sections hinged directly together and provided with a fastening device, the sections holding and enclosing the thermometer tube, but being open at one end to permit the mercury bulb to extend beyond, and there being in one of the sections a longitudinal slot through which may be read the scale indicating the degree of temperature.

APPARATUS FOR COOLING LIQUIDS.—William L. Spoon, Jr., Burlington, N. C. For cooling hot water or other liquid used in ice machines, etc., this inventor has devised an apparatus which is designed to be very effective, while permitting the use of the liquid over and over again with a minimum percentage of loss by evaporation. It comprises a perforated casing into the upper end of which a current of air is to be forced, a nozzle connected with the liquid supply spraying liquid into the casing, while the latter has a perforated zigzag supporting leg containing perforated plates. The liquid is thus atomized and sprayed in finely divided state, and at the same time subjected to a current of air of ordinary or low temperature, causing accelerated evaporation and cooling.

STERILIZING APPARATUS.—Arthur J. Vause, Sydney, New South Wales. For sterilizing milk and other liquids, and the receptacles in which the milk is placed, as well as for automatically bottling and corking the milk, this inventor has devised an apparatus in which the milk is first passed in bottles through a series of inclined ways, kept at varying and adjusted temperature, passing from thence to be received in a steam jacketed container, from which it passes through a deodorizer and thence to a filling apparatus. The apparatus is provided at various points with thermometers, according to which the temperature may be regulated as desired.

WATER COCK.—Maurice Andriveau, Paris, France. This invention relates to cocks in which automatic closing takes place, and provides a cock which will have a double closing action, and which at each operation supplies only a predetermined quantity of water. The valve casing has two apertured seats, in both of which the cutoff valve, constructed in two longitudinally adjustable sections, may seat itself, the length of the valve being changeable, there being means for changing the pressure on one side to cause the valve to move from one seat to the other. The valve will operate in any position, with the outlet facing upward, downward or laterally.

WASHING MACHINE.—Alexander E. Hoiges, Tecumseh, Oklahoma Ter. In a suitably constructed frame, according to this invention, a semi-circular receptacle is mounted to rock, there being within it a rubbing cylinder journaled in a frame with which is loosely connected an arm adapted to receive a swinging motion from the receptacle to move the rubbing cylinder in an opposite direction to the movement of the receptacle. By this means a proper rubbing and washing of the clothes is effected without danger of tearing them, the machine being easily operated and of simple and durable construction.

BOSOM PAD.—Dora Harrison, Lansing, Mich. This pad is an improvement on a formerly patented invention of the same inventor, providing an improved dress form readily applied to or removed from the pockets of corsets and other garments, and designed to insure a proper fitting of the dress. It is made in two pad sections, each having a back and front section with meeting edges having flanges lying snugly against each other, a welt surrounding and cemented to the flanges, while lace arms are secured by adjustable lacing to the welts of the pad sections.

ROLLING PIN.—Anson B. Fowler, Shelton, Wash. This device may be used as an ordinary rolling pin, in the preparation of dough for the oven, or with a flour delivery for sprinkling the dough to be rolled, to prevent it from sticking or adhering to the pin, and with this view is made with two shells, one within the other, and each having perforations, which may be brought in line with each other or not, as desired, the inner shell forming a flour receptacle. The parts are readily detachable to facilitate cleaning.

Designs.

SEPARATOR.—Frank H. Congdon, East Greenwich, R. I. This invention relates to separators used in spinning machinery, such as the Doyle separator, and embodies an improved form thereof. The blades are so curved as to present fewer chances of collecting lint and dirt, and are also lighter, giving the ring rail less weight to move.

GLASS PITCHER.—Joseph Wilson, New York City. This pitcher has panels decorated with "panties," and prismatic panels at each side of such panels, box panels crossing both the others.

BICYCLE LUGGAGE CARRIER.—A. J. Gilfillan, Smethport, Pa., and W. H. White, Nyack, N. Y. This is a bracket device to be fitted on the steering head and having arms projecting from each side adapted to conveniently carry a variety of packages.

SPOON HANDLE.—Herinad J. Klumpp, Portland, Oregon. On the obverse side this handle represents interlaced ribbons, with panels containing floral figures, while on the reverse side are scroll and shell figures and a beaded ribbon following the margin of the head.

NOTE.—Copies of any of the above patents will be furnished by Munn & Co. for 10 cents each. Please send name of the patentee, title of invention, and date of this paper.

Business and Personal.

The charge for insertion under this head is One Dollar a line for each insertion; about eight words to a line. Advertisements must be received at publication office as early as Thursday morning to appear in the following week's issue.

- Marine Iron Works. Chicago. Catalogue free.
- "U. S." Metal Polish. Indianapolis. Samples free.
- Emery, etc., etc. The Tanite Co., Stroudsburg, Pa.
- Gasoline Brazing Forge, Turner Brass Works, Chicago
- Yankee Notions. Waterbury Button Co., Waterbury, Ct.
- Power Hammers. Jenkins & Lingle, Bellefonte, Pa.
- Handle & Spoke Mch'y. Ober Lathe Co., Chagrin Falls, O.
- Analyses, all kinds; water a specialty. Chemist, Ripon, Wis.
- Wanted, small Metal Novelties for adv. purposes. What have you? G. Felsenthal, 215 Dearborn St., Chicago.
- FERRACUTE Machine Co., Bridgeton, N. J. Full line of Presses, Dies and other Sheet Metal Machinery.
- Improved Bicycle Machinery of every description. The Garvin Machine Co., Spring and Varick Sts., N. Y.
- Concrete Houses—cheaper than brick, superior to stone. "Ransome," 757 Monadnock Block, Chicago.
- The celebrated "Hornsby-Akroyd" Patent Safety Oil Engine is built by the De La Vergne Refrigerating Machine Company. Foot of East 138th Street, New York.
- The best book for electricians and beginners in electricity is "Experimental Science," by Geo. M. Hopkins. By mail, \$4. Munn & Co., publishers, 361 Broadway, N. Y.

Send for new and complete catalogue of Scientific and other books for sale by Munn & Co., 361 Broadway, New York. Free on application.

Notes & Queries

HINTS TO CORRESPONDENTS.

Names and Address must accompany all letters or no attention will be paid thereto. This is for our information and not for publication.

References to former articles or answers should give date of paper and page or number of question.

Inquiries not answered in reasonable time should be repeated; correspondents will bear in mind that some answers require not a little research, and though we endeavor to reply to all either by letter or in this department, each must take his turn.

Buyers wishing to purchase any article not advertised in our columns will be furnished with addresses of houses manufacturing or carrying the same.

Special Written Information on matters of personal rather than general interest cannot be expected without remuneration.

Scientific American Supplements referred to may be had at the office. Price 10 cents each.

Books referred to promptly supplied on receipt of price.

Minerals sent for examination should be distinctly marked or labeled.

(7369) **J. W. B. writes:** About what size wire, number of sections, etc., to wind on laminated core of following size. You will help me out of a quandary:

- Length of core..... 5½ inches.
- Diameter of core..... 3¼ "
- Number of laminations..... 30
- Sections..... 10
- Diameter between fields..... 3¼ "

I wish to obtain an E. M. F. of 52. A. If your field is of the proper strength, wind the armature with 24 sections of 12 turns each of No. 16 wire. You can change the number of sections if you keep the total number of turns the same. See SCIENTIFIC AMERICAN SUPPLEMENT, No. 600, for further directions for winding. You can place sixteen No. 16 wires to the inch.

(7370) **J. L. B. writes:** Will you kindly answer for me the following? 1. Why does not the magnetic pole coincide with the geographic pole? A. This is as yet one of the hidden secrets in the physical constitution of the earth. 2. How is artificial stone made? A. Articles in SCIENTIFIC AMERICAN SUPPLEMENTS, Nos. 183, 355 and 868, give very full accounts of the various kinds of artificial stone. 3. What is meant by a "car mile" in speaking of building railroads? A. A "car mile" is a term used in estimating the cost of running cars. It is the cost of running one car one mile. 4. How are billiard balls turned? A. For method of turning billiard balls see Notes and Queries, No. 7353, SCIENTIFIC AMERICAN, February 19, 1898. 5. In what number of SCIENTIFIC AMERICAN or SUPPLEMENT may I find an account of how artificial ice is made, for or in skating rinks? A. Skating rinks with artificial ice are illustrated and described in SCIENTIFIC AMERICAN SUPPLEMENTS, Nos. 35, 738 and 892. 10 cents each, mailed.

(7371) **C. N. S. asks for formula** for preparation to stick wood veneer on tin or metal of any kind. Have used glue and nitric acid, also glue and garlic, but neither works satisfactorily. The veneer will peel after a time. I want something that will adhere permanently. A. M. Eliel gives the following formula for a mixture which can be used for metal, glass or wood: Gum tragacanth, 30 grammes; acacia gum, 120 grammes; water, 500 cubic centimeters. Dissolve, filter and add 2¼ grammes of thymol suspended in 120 cubic centimeters of glycerine; then add enough water to make up the bulk to 1 liter. This bath will keep a long time.

TO INVENTORS.

An experience of nearly fifty years, and the preparation of more than a hundred thousand applications for patents at home and abroad, enable us to understand the laws and practice on both continents, and to possess unequalled facilities for procuring patents everywhere. A synopsis of the patent laws of the United States and all foreign countries may be had on application, and persons contemplating the securing of patents, either at home or abroad, are invited to write to this office for prices, which are low, in accordance with the times and our extensive facilities for conducting the business. Address Munn & Co., office SCIENTIFIC AMERICAN, 361 Broadway, New York.

INDEX OF INVENTIONS

For which Letters Patent of the United States were Granted

FEBRUARY 22, 1898,

AND EACH BEARING THAT DATE.

[See note at end of list about copies of these patents.]

- Air brake, H. F. Noyes..... 599,348.
- Air brake, street car, C. A. Gray..... 599,421.
- Amusement device, W. J. Gordon..... 599,420.
- Animal trap, A. T. Sullivan..... 599,407.
- Ash remover and sifter, E. W. Campagna..... 599,384.
- Axles, apparatus for manufacturing, C. M. Schwab..... 599,638.
- Band cutter and feeder, V. C. Bailey..... 599,584.
- Band slide, E. J. Van Sickle..... 599,542.
- Battery. See Electric battery. Electrical primary battery. Secondary battery.
- Bearing, ball, H. Meltzer..... 599,621.
- Bedstead, folding, N. P. Bradish..... 599,380.
- Bicycle crank shaft, Ferris & Hunt..... 599,652.
- Bicycle frame construction, Kenyon & Wiewell..... 599,450.
- Bicycle guard, D. W. Stevenson..... 599,406.
- Bicycle handle, C. J. Kintner..... 599,564.
- Bicycle handle bar, F. C. Rockwell..... 599,359.
- Bicycle holder, L. H. Snyder..... 599,645.
- Bicycle lamp attachment, C. F. Walker..... 599,607.
- Bicycle stand and lock, I. B. Hewitt..... 599,607.
- Bicycle support, C. B. Harkness..... 599,446.
- Bicycles, etc., pedal for, M. Matthews..... 599,619.
- Billiard cushion, W. E. Taft..... 599,371.
- Binding implement, C. E. Allshouse..... 599,498.
- Bit, M. Steudner..... 599,537.
- Board, pressure, laundry board.
- Boiler. See Steam boiler.
- Boiler gage glass protector, G. J. J. Manvell..... 599,511.
- Book rest and fan, combined, B. Sherman..... 599,574.
- Boot or shoe nailing machine, A. Newton..... 599,627.
- Boring and turning machine, upright, L. H. Colburn..... 599,551.
- Bottle and stopper, J. W. McDougall..... 599,624.
- Bottle attachment, nuclage, L. H. Thomas..... 599,461.
- Bottle packing case, B. W. Atwood..... 599,311.
- Bottle stopper and pour out, L. H. Thomas..... 599,490.
- Bowling alley, E. Keisky..... 599,477.
- Box folding machine, W. Lederer..... 599,615.
- See Air brake. Sled brake.
- Brake mechanism for railway carriages, etc., H. L. Constable..... 599,544.
- Bread and pastry board, W. Harris..... 599,427.
- Buckle, N. Nelson..... 599,626.
- Burner. See Hydrocarbon burner.
- Burning and heating appliance, H. S. Garr..... 599,499.
- Button or stud for shirt bosoms, F. A. Ballou..... 599,489.
- Cabinet, C. L. Hendricks..... 599,387.
- Camera, magazine, K. E. & F. W. Conley..... 599,314.
- Camera, photographic magazine, R. E. Flora..... 599,516.
- Can. See Oil can. Sealing wax can.
- Candle holder, F. W. Grundmann..... 599,527.
- Candy cutting machine, C. C. York..... 599,414.
- Car brake shoe slack adjuster, railway, H. F. Shaw..... 599,662.
- Car coupling, L. L. Bircelow..... 599,588.
- Car coupling, H. Laake..... 599,567.
- Car coupling, S. Reynolds..... 599,358.
- Car door, J. W. Kennedy..... 599,507.
- Car draw bar, railway, C. A. Schroyer..... 599,637.
- Car fender, I. J. Neracher..... 599,470.
- Car fender, railway, A. M. Phelps..... 599,637.
- Car stopper, automatic, J. Neracher..... 599,471.
- Cars, etc., safety guard and truck for, A. M. Phelps..... 599,629.
- Card box, G. W. Weaver..... 599,484.
- Carpet sweeper, A. B. Linn..... 599,671.
- Case. See Bottle packing case.
- Cash register, C. Forth..... 599,418.
- Cash register and indicator, H. M. Neer..... 599,625.
- Cask pitching apparatus, H. Rauch..... 599,476.
- Centrifugal machine, F. Hugerhoff..... 599,422.
- Chair. See Opera chair.
- Chair iron, Harrison & Wolf..... 599,502.
- Churn, R. H. Hurlbut..... 599,562.
- Churn, Coppock & Miller..... 599,598.
- Churn, J. R. Hailey..... 599,332.
- Cleaner. See Fruit cleaner.
- Clothes wringer, C. Wheeler, Jr..... 599,431.
- Coffin, F. M. Stuber..... 599,513.
- Coffin lowering machine, C. T. Fowler..... 599,669.
- Collar fastener, shirt, C. R. Mullen..... 599,530.
- Color value curtain shutter, F. J. Harrison..... 599,670.
- Cooker, steam, D. Mayer..... 599,512.
- Cooler. See Milk cooler.
- Corn sheller, Allen & Beardon..... 599,582.
- Corn sheller conveyor, J. H. Gilman..... 599,500.
- Corner plate, H. Liebreich..... 599,395.
- Corner slaying machine, H. A. Inman..... 599,563.
- Corner strip anchor plate, F. A. Mitchell..... 599,343.
- Cotton cleaning mechanism, seed, M. Swenson..... 599,575.
- Cups, spring for, E. M. Hulce..... 599,337.
- Countersinking machine, dovetail, G. A. Huben..... 599,655.
- Cuff links, detachable fastener for, J. M. Parkinson..... 599,353.
- Cultivator, C. F. Pogue..... 599,401.
- Cup. See Soap cup.
- Cutter. See Glass cutter.
- Cyclometer, E. G. Dorchester..... 599,320.
- Damper, grate, Keifel & Zipp..... 599,335.
- Dealer, automatic, G. C. Sharpe..... 599,362.
- Dish, crushed fruit, G. Bohner..... 599,651.
- Door checks and closers, lever connection for, C. O. Case..... 599,415.
- Door hanger, G. C. Gardner..... 599,498.
- Doors, double sliding, A. G. Bierbach..... 599,490.
- Draining machine, J. Edmonds..... 599,442.
- Drawing apparatus, R. Richter..... 599,402.
- Dress shield extender, H. L. Rutter..... 599,533.
- Dryer. See Fruit drier. Steam drier.
- Drier, A. S. Livengood..... 599,509.
- Drill. See Rail drill.
- Dropper. See Medicine dropper.
- Drum, heating, G. M. Ridenour..... 599,632.
- Dye, black trisazo, C. Bis..... 599,532.
- Dye, black alizarin, R. E. Schmidt..... 599,425.
- Dye derived from anthraquinone, green, R. E. Schmidt..... 599,426.
- Dye derived from quinzarin, green, R. E. Schmidt..... 599,427.
- Egg heater, E. J. Scopes..... 599,661.
- Elastic tire wheel, D. A. McKittrick..... 599,517.
- Electric battery, Shewsbury & Dobell..... 599,405.
- Electric light support, incandescent, F. Whitaker..... 599,543.
- Electric meter driving gear, G. A. Le Fevre..... 599,508.
- Electric resistance conductor, H. G. O'Neill..... 599,351.
- Electric wire holding appliance, H. A. McCoy..... 599,346.
- Electrical primary battery, J. B. Whittemore..... 599,411.
- Elevator. See Mail and parcel elevator.
- Elevator hoist, T. Mason..... 599,618.
- Elevator safety appliance, J. D. Conner..... 599,523.
- Engine. See Gas engine. Rotary engine. Vapor engine, F. J. E. Bruguiere..... 599,381.
- Engines, electric igniter for explosive, H. F. Probert..... 599,354.
- Engines, electric igniter for gas, F. E. Culver..... 599,316.
- Explosives, making, J. E. Blomen..... 599,589.
- Fly screen, C. T. Siebert..... 599,372.
- Fabric. See Knitted fabric.
- Feed trough, N. R. Medaugh..... 599,572.
- Fermenting squares and vats, construction of, W. Cutler..... 599,599.
- Finishing roll, J. Hall..... 599,469.
- Fire alarm box, Hayes & Fisher..... 599,654.
- Firearm, box magazine, J. M. Browning..... 599,587.
- Firearm, magazine, Bennett & Mason..... 599,587.
- Fire extinguisher, G. C. Hale..... 599,330.
- Fishing tackle holder, H. D. Streator..... 599,370.
- Fisk, J. C. Korn..... 599,614.
- Fly screen, C. T. Siebert..... 599,372.
- Fly trap, automatic, C. C. Grenzbecher..... 599,501.
- Foot covering, J. H. Meeteer..... 599,341.
- Forging and sharpening rock drills, etc., apparatus for, H. C. McDonald..... 599,453.
- Forging hollow shafts, guns, etc., mechanism for, Frame. See Photographic printing frame. Sewing machine quilting frame..... 599,472.
- Fruit cleaner, W. J. McKay..... 599,515.
- Fruit drier, G. A. & B. G. Stevens..... 599,647.

- Furnace blast pipe and bridle, blast, T. E. Beaghan..... 599,668.
- Game apparatus, baseball, E. D. Mitchell..... 599,452.
- Gas compressor, ammonia, J. J. Bailey..... 599,487.
- Gas engine, Fraser..... 599,496.
- Gas engine, W. E. White..... 599,375.
- Gas engine attachment, W. E. White..... 599,376.
- Gas generator, acetylene, H. W. & E. E. Laun..... 599,394.
- Gas generator, acetylene, F. McMurray..... 599,347.
- Gas machine, hydraulic blower and pressure apparatus for, Stubbs..... 599,538.
- Gate, S. E. Auker..... 599,583.
- Gate, R. Hayden..... 599,503.
- Gear, driving, V. E. Doremus..... 599,321.
- Generator. See Gas generator.
- Glass cutter, window, Meissner & Koenig..... 599,620.
- Grease trap for sinks, baths, etc., H. Sieber..... 599,623.
- Gun, pneumatic, W. L. Breath..... 599,549.
- Gun turrets, apparatus for operating, G. W. Dickie..... 599,600.
- Hanger. See Door hanger. Pipe hanger.
- Harness attachment, racing, J. H. Snapp..... 599,365.
- Hat pin, W. R. Gorrell..... 599,596.
- Heater. See Water heater.
- Hides, skins or leather, machine for treating, J. Hall..... 599,331.
- Hoisting and lowering gear, Bell & Maguire..... 599,437.
- Hoisting apparatus, W. Sauer..... 599,480.
- Horse shoe, Olcott..... 599,350.
- Hydrocarbon burner, J. H. White..... 599,577.
- Injector, steam, R. Pattison..... 599,473.
- Ink well, Killion & Perdue..... 599,423.
- Insect exterminator, E. F. Robertson..... 599,404.
- Insulator, strain, J. Clegg..... 599,453.
- Jack. See Lifting jack. Wagon jack.
- Jar cover fastening, fruit, O. Selg..... 599,458.
- Joint. See Metallic frame joint. Steam joint.
- Knitted fabric, W. M. Bell..... 599,438.
- Knitting machine, straight bar, Barfoot & Johnson..... 599,435.
- Knob attachment, J. H. Shaw..... 599,363.
- Lacings, machine for securing metal points to, L. P. Bosworth..... 599,548.
- Lamp, C. M. Lungren..... 599,528.
- Lamp, M. P. Stevens..... 599,520.
- Lamp burner shield, bicycle, Elton & Smith..... 599,525.
- Lamp, electric, H. J. Woodward..... 599,535.
- Lamp, electric arc, Skinner & Bacon..... 599,580.
- Lamp radiator attachment, arc, Stenz & Westermann..... 599,519.
- Lantern, bicycle, Beardsley & North..... 599,467.
- Lathe attachment, G. C. Malone..... 599,510.
- Lawn rake, scraper and cutter, combined, E. Starkweather..... 599,368.
- Lead from its ores, extraction of, H. R. Angel..... 599,310.
- Lemonade making device, J. C. Gundelfinger..... 599,605.
- Lifting jack, Starrett & Welsh..... 599,536.
- Liquids in form of a stream, implement for discharging, Bunnell & Kintner..... 599,383.
- Liquids, means for controlling flow of, W. C. L. Van Schaik..... 599,462.
- Loading dirt, gravel, etc., onto wagons, device for, Lawrence & Cooper..... 599,340.
- Loom harness leveling device, H. Wyman..... 599,675.
- Mail marking machine, H. E. Wagoner..... 599,463.
- Mail or parcel elevator, J. A. Cabot..... 599,483.
- Manhole frame, E. S. Dorr..... 599,441.
- Manhole frame, H. W. Sanborn..... 599,457.
- Match safe, S. Maxwell..... 599,388.
- Measurer, H. H. Woodward..... 599,674.
- Measuring variable angles between rotating bodies, machine for, C. Barus..... 599,522.
- Meat sawing machine, D. Lippy..... 599,569.
- Medicine dropper, W. R. Sine..... 599,642.
- Metal drilling machine, J. Reece..... 599,356.
- Metallic ball, W. S. Tuttle..... 599,441.
- Meter, J. L. Dodge..... 599,494.
- Milk apparatus for testing amount of fat in, A. W. Stokes..... 599,369.
- Milk cooler, S. Snider..... 599,644.
- Mine draining siphon, J. C. Souleyret..... 599,396.
- Musical instrument, S. Hoedel..... 599,426.
- Necktie retainer, J. A. Flomerfelt..... 599,326.
- Nut lock, W. E. Caylor..... 599,385.
- Nut lock, G. H. Dye..... 599,554.
- Nut lock, S. O. Haskins..... 599,448.
- Office indicator, J. A. Leighton..... 599,657.
- Oil can, J. W. Backer..... 599,380.
- Opera chair, T. S. Wells..... 599,430.
- Ordnance, breach loading, V. C. Tasker..... 599,482.
- Organ, reed, R. J. Bennett..... 599,439.
- Ozone producing apparatus, M. Otto..... 599,455.
- Paper holder, roll, J. Spillinger..... 599,646.
- Paper machine, floor, S. A. Pettersen..... 599,521.
- Paper shifting gripper, T. C. Dexter..... 599,319.
- Patent for brushes for waxing floors, Durel & Drouard..... 599,495.
- Pavements, roadways, etc., composition of matter for, J. Johnson..... 599,506.
- Pen, fountain, C. W. Boman..... 599,500.
- Pencils, etc., holder for, E. C. Lindley..... 599,616.
- Permutation lock, H. Bruck..... 599,596.
- Permutation lock, C. J. Kintner..... 599,585.
- Photographic films, apparatus for manufacturing, H. M. Reichenbach..... 599,631.
- Photographic framing, E. Crooks..... 599,440.
- Photographic studio operating lever, H. White..... 599,576.
- Pianoforte action, upright, F. L. Becker..... 599,585.
- Picture supporter, E. J. Fitzgerald..... 599,325.
- Pin. See Hat pin.
- Pin lock, W. E. Sparks..... 599,367.
- Pipe. See Sheet metal pipe. Tobacco pipe.
- Pipe hanger, C. MacTaggart..... 599,424.
- Pipe or nut wrench, W. T. Williams..... 599,578.
- Pipe or tube coupling, E. T. Greenfield..... 599,558.
- Pipe wrench, B. Ross..... 599,673.
- Placket fastener, J. H. McCauley..... 599,672.
- Planing machine, C. A. Peterson..... 599,517.
- Plow row gage, C. N. Rountree..... 599,478.
- Pneumatic tube switch and back stop, E. A. Fordyce..... 599,557.
- Pocket garment, Bartell & Shields..... 599,547.
- Power transmitter, G. J. Altham..... 599,546.
- Power transmitting mechanism, G. J. Altham..... 599,545.
- Preserving alimentary substances, apparatus for, A. Schorke..... 599,534.
- Propeller, chain, J. M. Mays..... 599,451.
- Puffing machine, fabric, J. A. Groebli..... 599,328.
- Puller. See Stamp puller.
- Pump, oil well, J. P. Wright..... 599,544.
- Puzzle, W. Bowling..... 599,533.
- Radiator, J. Keith..... 599,611.
- Rail drill, M. M. Moore..... 599,309.
- Railway rail fastener, Mims & Dunkle..... 599,622.
- Railway signal, A. J. Armstrong..... 599,521.
- Railway signaling mechanical, B. A. Carr et al..... 599,636.
- Railway signal operating system, B. C. Rowell..... 599,456.
- Railway system, electric, J. D. Gibbs..... 599,604.
- Railway system, electric, J. M. Murphy..... 599,344.
- Railway tie, metal, W. H. Scott..... 599,639.
- Registering device, Smith & Freir..... 599,394.
- Reverting machine, H. L. Charles..... 599,597.
- Riveter, P. H. Smith..... 599,643.
- Riveting machine, F. A. Jaber..... 599,505.
- Rolling balls, machine for cold, E. Rivett..... 599,634.
- Rolling rods or wire, machine for, A. Kenworthy..... 599,336.
- Rotary engine, L. Stoner..... 599,648.
- Rotary engine, Wampler & Bloom..... 599,410.
- Rotary engine, reversible, W. Taylor..... 599,665.
- Sampling mill, J. H. Stratton..... 599,649.
- Sand distributing device, J. J. Murray..... 599,345.
- Sash balance, E. A. E. Braunlich..... 599,313.
- Sash fastener, C. P. Flora..... 599,655.
- Sash fastener, J. J. Wade..... 599,637.
- Saw, J. Guedel..... 599,327.
- Saw filing device, R. F. Foss..... 599,329.
- Scale, C. H. Mattice..... 599,529.
- Scale, air, H. J. Winterlich..... 599,378.
- Screen. See Window screen.
- Screen, G. W. Cross..... 599,468.
- Sealing wax can, F. H. Wightman..... 599,412.
- Secondary battery, W. A. Crowds..... 599,315.
- Separator, Reeves & Kailor..... 599,357.
- Sewing machine guide, A. D. Fenwick..... 599,444.
- Sewing machine needle holder, F. B. Hopewell..... 599,561.
- Sewing machine quilting frame, Huff & McKinley..... 599,388.
- Shaft coupling and cycle hanger, I. J. Wilson..... 599,434.
- Shears gage, L. V. Moulton..... 599,659.
- Sheet metal pipe, R. J. Northam..... 599,628.
- Sheller. See Corn sheller.
- Shirt, bathing, L. M. Uppercu..... 599,408.
- Shoe, bicycle, A. J. Carmeyer..... 599,491.
- Shoe upper lacing device, S. A. West..... 599,485.
- Shovel handle, C. S. McIntire..... 599,514.
- Signal. See Railway signal.
- Skirt guide, M. A. Petgen..... 599,573.
- Sled brake, J. M. Kruzan..... 599,546.
- Slicer, vegetable, S. S. Dreisbach..... 599,323.
- Soap cup or holder, J. Schwechler..... 599,361.
- Spinning machine, ring, M. E. Sullivan..... 599,539.
- Spinning or twisting machine, Emond & Labeje..... 599,443.
- Spoke heading and bending mechanism, wire, J. Batey..... 599,426.
- Spout, sap, A. Ring..... 599,633.
- Sprocket wheel and chain, J. S. Kidd..... 599,612.
- Stamp tapper, C. A. McClair..... 599,400.
- Steam boiler, E. Hook..... 599,609.
- Steam drier, rotary, Healy & Kraft..... 599,386.
- Steam joint for rotary cylinders, M. J. Ronca..... 599,406.
- Steel and cast metal, making composite article of manganesse, E. Samuel..... 599,636.
- Stopper. See Bottle stopper.
- Stove, J. A. Hampton