

# SCIENTIFIC AMERICAN

[Entered at the Post Office of New York, N. Y. as Second Class matter.]

A WEEKLY JOURNAL OF PRACTICAL INFORMATION, ART, SCIENCE, MECHANICS, CHEMISTRY, AND MANUFACTURES.

Vol. LXXVI.—No. 9.  
ESTABLISHED 1845.

NEW YORK, FEBRUARY 27, 1897.

[\$3.00 A YEAR.  
WEEKLY.]

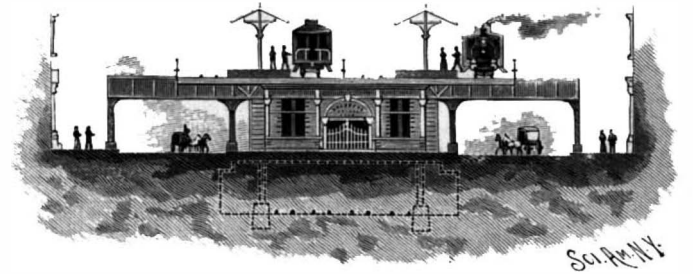
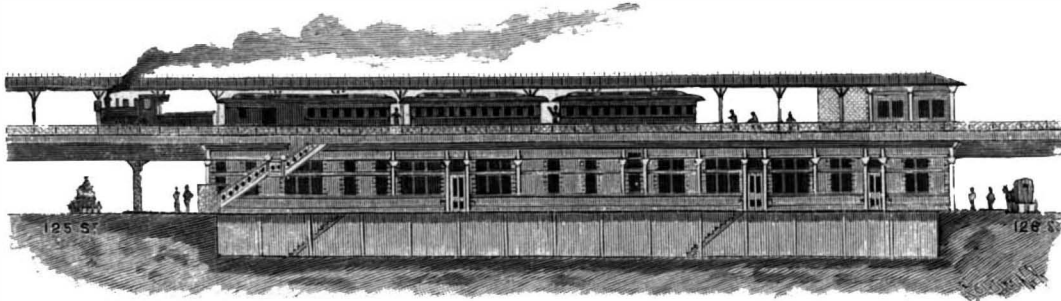

THE NEW ONE HUNDRED AND TWENTY-FIFTH STREET STATION ON PARK AVENUE.

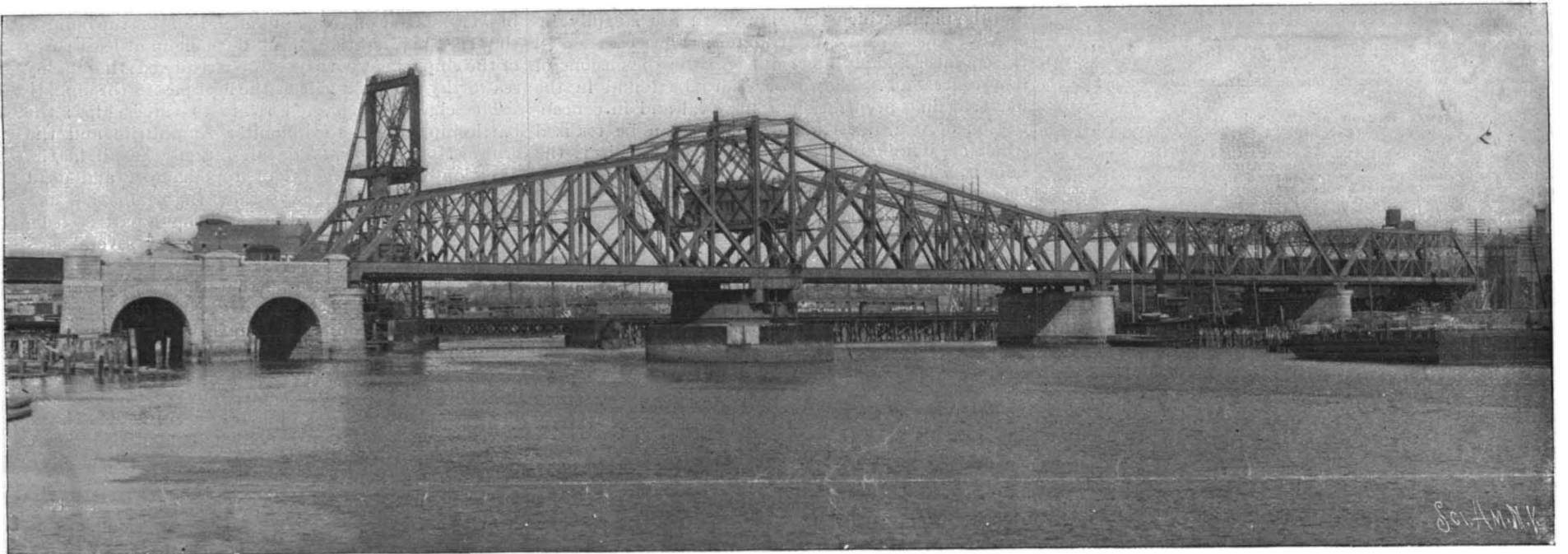

GENERAL VIEW OF THE HARLEM RIVER BRIDGE.



PORTAL VIEW OF THE FOUR TRACK STEEL DRAWBRIDGE.

COMPLETION OF THE NEW YORK CENTRAL FOUR TRACK STEEL VIADUCT AND DRAWBRIDGE, NEW YORK CITY.—[See page 183.]

Scientific American.

ESTABLISHED 1845.

MUNN & CO., - - - EDITORS AND PROPRIETORS.

PUBLISHED WEEKLY AT

No. 361 BROADWAY, - - NEW YORK.

TERMS FOR THE SCIENTIFIC AMERICAN.

One copy, one year, for the U. S., Canada or Mexico, \$3.00

The Scientific American Supplement

is a distinct paper from the SCIENTIFIC AMERICAN. THE SUPPLEMENT is issued weekly.

Building Edition of Scientific American.

THE BUILDING EDITION OF THE SCIENTIFIC AMERICAN is a large and splendidly illustrated periodical, issued monthly, containing floor plans and perspective views pertaining to modern architecture.

Export Edition of the Scientific American

with which is incorporated "LA AMERICA CIENTIFICA E INDUSTRIAL," or Spanish edition of the SCIENTIFIC AMERICAN, published monthly, uniform in size and typography with the SCIENTIFIC AMERICAN.

NEW YORK, SATURDAY, FEBRUARY 27, 1897.

Contents.

(Illustrated articles are marked with an asterisk.)

Accidents, liability of owner for 136
Archæological news 135
Barometer and storm alarm 132

TABLE OF CONTENTS OF Scientific American Supplement

No. 1104.

For the Week Ending February 27, 1897.

Price 10 cents. For sale by all newsdealers.

I. ARCHÆOLOGY.—Medical Treasure Trove in Switzerland..... 17644
II. BOTANY AND HORTICULTURE.—Cyclamens.—1 illustration..... 17642
III. CHEMISTRY.—Sensitive Litmus Paper..... 17644

THE ECONOMIES OF CONCENTRATION.

If those columns of the daily and weekly press which are devoted to a recital of the current news of the world are a sure indication of the tastes of the majority of readers, the age in which we live must have a profound admiration for the element of bigness as such.

How comes it that mere bulk or bigness should be regarded as such a commendable quality, especially in the great works of construction which are characteristic of the present day?

Why is it then that the great industrial corporations and the plants which they lay down are steadily increasing in size; why does each successive creation of the engineer and architect outstrip the dimensions of its predecessors?

The railroad companies have found that the larger the individual freight car and the more powerful the locomotive, the cheaper will be the cost of carrying a unit of freight for a unit of distance.

The same considerations have produced the same results in the locomotive. Of two locomotives, one of which can haul twenty loaded cars and the other forty, the larger machine will do double the work for much less than double the coal consumption.

The increase in the size of ocean steamers, both for freight and passenger traffic, is due to the same considerations of economy, and this is particularly true of the huge cargo boats, of which the Pennsylvania, illustrated in the present issue, is the latest and largest.

Great as are the dimensions of this ship, they are soon to be eclipsed by another marine giant whose keel is already laid in the Belfast yard in which the Pennsylvania was built.

THE LESSONS OF THE RECENT NAVAL MANEUVERS.

Naval maneuvers, such as have recently been carried out by a fleet of United States warships under Admiral Bunce, play an important part in the creation of a modern navy.

At the close of the recent maneuvers Admiral Bunce sent in a report to the Navy Department, which speaks of the behavior of the ships during the heavy gale which overtook the fleet off Cape Hatteras, when, it will be remembered, several seamen were injured or carried overboard by the heavy seas which swept over the decks.

The changes suggested relate to three ships: the battleship Maine, the monitor Amphitrite and the cruiser Montgomery. The alterations are all in the direction of the removal of top hamper and dead weight. The admiral says that the Maine has too much superstructure, and suggests that a part of it be removed.

The above recommendations, based upon practical experience, and forwarded to the department by an officer of such long experience and undoubted ability, are of the greatest value, and should be welcomed by the Construction Department, where, of necessity, theories as to the behavior of warships are so plentiful and facts so few.

We must confess that it looks to us as though the admiral was as clearly in the right as the Construction Department is distinctly in the wrong. Our ships are not built for show, or to make phenomenal speed under specially favorable conditions or to creep cautiously from port to port over smooth seas and under favorable skies.

The United States have every reason to be proud of a navy whose construction has been carried out in the brief period of a dozen years. It was an entirely new



class of work, for which at the commencement of the task we possessed but few tools and less experience. We had to manufacture the tools, lay down the plants, and gain the experience as we proceeded. The result has been the creation of a compact and homogeneous navy which in quality is second to none in the world. We have not been content to follow closely in the beaten track of foreign designers, but have introduced many original features which render some of our ships the most effective in the world. The fact that the work was new, and that the designs were many of them original, rendered it morally certain that some mistakes would be made; but our ships have developed only such defects as have appeared from time to time in those of other countries, and are inseparable from such difficult and experimental work as that of warship construction. If the defects exist, it is best they should be made known. The over-sensitiveness to criticism which has been displayed is altogether unreasonable, and indirectly may work much harm to the interest of the navy.

If the department is going to discredit and discourage such practical tests and such frank criticism as are contained in the report in question, it will be guilty of the blindest folly. There is everything to gain by encouraging the line and staff officers in giving a frank expression of opinion as to the merits or demerits of the ships which are turned over to their care. It would be absurd, in dispatching a fleet for its annual maneuvers, to tell the officers that their vessels are delicate toys to be handled with a gentle touch. There is nothing delicate about actual war; it is rough from beginning to end, and the mimic warfare of naval maneuvers should represent some of its rough conditions if the maneuvers are to have their full practical value.

#### THE BROOKLYN BRIDGE IMPROVEMENTS.

The trustees of the New York and Brooklyn Bridge have received the report of the Board of Expert Engineers, consisting of Virgil C. Bogue, L. L. Buck and George H. Thompson, regarding the feasibility of running through cars from the Brooklyn elevated and electric railways across the bridge. According to the plans submitted by the committee, the surface railways will have a single track on each of the present roadways. At the Brooklyn end all the west bound cars will go down Washington Street to the roadway for west bound traffic, and all east bound cars on the other roadway will turn into Fulton Street. Vehicles using the roadways will not have to cross any car tracks at the bridge entrance. There will be a loop terminal with sidings for the cars of the various routes at the New York end of the bridge. The cars will stop on the siding to load and unload, and will then continue from the siding on to the main track and around the loop to the other side of the station. The platforms will be at the same level as the present platforms for the bridge cars. These tracks in the station will be over the present roadway, the sides of the station being altered so as to widen the building. For the elevated railroads two of the four tracks at each station and one of the stub switching tracks at the New York terminal will be given up to the through trains.

At the Brooklyn terminal the Brooklyn Elevated will connect with the Kings County elevated railroad, and all trains will use the Fulton Street line of the latter road, turning off at Tillary Street, and having one track on each side of the elevated yards of the bridge railway, thus avoiding all interference with the yards. The cars of the elevated railways will have to be provided with cable grips and side doors, and one car of each train must be a motor car for switching at the terminals and for propelling the train if necessary. It is at present intended that the bridge authorities will handle the elevated train during its trip over the structure. It is estimated that there will be one local bridge train to three elevated railway trains, as most of the traffic would consist of through passengers. The report has been favorably received by the bridge trustees.

The electric motors for switching the trains in the station of the bridge have been found to be very successful, and, when necessary, the motor cars can propel the trains over the bridge. All of the tracks in the terminal are now in use, and the crowding and confusion which resulted from the too severely taxed service is now in a great measure done away with. It is estimated there will be an annual saving of \$10,000 over the use of steam.

#### THE NEW YORK ELEVATED'S NEW POWER.

At a meeting of the Executive Committee of the Board of Directors of the Manhattan Railway Company, held on February 16, the General Manager, Mr. W. J. Frausoli, presented a report on the electrical system of operating the elevated railroads of Chicago, which he has spent considerable time in investigating. He also indorsed the report of the engineers who have been commissioned to inspect the Chicago roads. The general manager's statement was so favorable that by unanimous action the executive committee decided to give the same system a practical trial in New York City. The general sentiment seems to indicate that a similar system will finally be adopted on all of the Manhattan Railway Company's lines.

This company has for a long time been considering the advisability of changing their form of motive power. It is now operating 1,117 cars by 331 locomotives, but it will be readily seen that this system could not possibly be as economical as one in which the power was generated at one or two central stations. As the mileage of the Manhattan Railway Company is not very large, the power can be transmitted by electricity without the loss being very great. The system which it is proposed to adopt is essentially the same as that which has been in successful use at the Brooklyn Bridge terminals for a few weeks.

The Chicago elevated road uses the same system, using four car trains with a one and one-half minute headway, which is one-half the headway allowed on Third Avenue, at a slighter greater speed than that at which the Manhattan trains run, and in Chicago the stations are about the same distance apart as in New York. Mr. Frausoli finds that the operating expense is considerably less than where locomotives are in use. In Chicago the motor cars, which haul three cars, are also passenger coaches, a motor being placed on each truck, the current being taken from a third rail, and the operator stands at the controller, which is in a little cablike compartment built on the car platform; but in New York this arrangement will be modified by placing the motorman just inside the car at the end, the controller and other apparatus occupying about the space of three seats. Air for brakes is compressed by a pump operated by another small motor also under the car.

Mr. Russell Sage, the president of the company, states that the electrical system will be tried first on the Second Avenue line, where the travel is the lightest, and, as the system is extended, it will be applied to the other lines. No contracts for the equipment have been made as yet, but it is said that one large electrical company has been for a long time developing a system to meet the needs of the elevated lines in New York, so as to include power, light and heat for trains, light and heat for stations and power for elevators to be constructed at stations. The selection of the system will rest with a special committee of Manhattan directors composed of Messrs. Gould, Sage and Gallaway.

Electrical traction is particularly adapted for use on elevated roads, owing to the freedom from dust and smoke and the comparative noiselessness. The Manhattan Railway Company is certainly to be congratulated on their new move, and the results cannot fail to be satisfactory, both to the public and to the stockholders.

#### RECENT PATENT AND TRADE MARK DECISIONS.

Brush Electric Company v. Western Electric Company (U. S. C. C. A., 7th), 76 Fed., 761.

Double Carbon Electric Lamps.—In this case the Brush patent, No. 219,208, was held not to be void as being for a function or result, but that the claims are not to be construed as covering the arc-forming separation of each set of carbons as it begins to burn. The claims are limited to the mechanism, of which an essential feature is the dissimultaneous initial separation of the carbons, and, therefore, it is not infringed by the lamp shown in the Scribner patents, No. 418,758, 502,535, 502,536, in which the initial separation is simultaneous.

Effect of Interlocutory Decree on a Subsequent Suit.—A decree awarding a perpetual injunction in a patent suit with the order of reference to a master to ascertain the damages is interlocutory and not final, and, therefore, does not operate as an estoppel in a subsequent suit.

Construction of Claims.—When a device designed as an improvement in a well advanced art is described as having features of construction adopted accomplish specific results or mode of operation and the claim of the patent is for that device, the features so described and covered by the claims cannot be rejected or treated as of secondary importance in order to extend the patent over other forms or features not described.

Standard Elevator Company v. Crane Elevator Company (U. S. C. C. A., 7th), 76 Fed., 767.

Elevators.—The Reynolds patent, No. 436,122, for an improvement in means for controlling the operation of elevators in which the characteristic feature is the use of two cables, the ends of which are attached to the car, whereby they counterbalance each other and secure substantial steadiness and uniformity of force in the movement of the controlling device by the attendant, is held to be valid and not anticipated by elevators with only a single coil or cable.

Elevators.—The Reynolds patent, No. 328,614, for combinations constituting improvements in hydraulic apparatus, construed and held valid and infringed.

Form of Assignment of Error on Appeals.—In this case an assignment of error asserted that the claims of two or more patents involved in the suit were valid and infringed. While such assignment must in strictness be overruled if any one of the claims is valid or infringed, the court may consider the questions involved as if the assignment had been distributive or separable, on the ground that the court on appeal in an equity cause may reverse the case for an error not assigned.

Appeal from Decrees in Patent Cases.—In this case

a decree was made adjudging that the complainant was the owner of the patents sued upon, that the claims of some of the patents were valid and that the defendants had infringed them, and a perpetual injunction was granted. It was held on appeal that such decree was final upon the matter so adjudicated and, therefore, was appealable under section 6 of the act establishing the Circuit Court of Appeals, and that it was not an interlocutory decree under the amended section 7, Act 1875, although the decree refers the cause to a master for an accounting of profits.

Final Appealable Decrees.—A decree may be a final appealable one, although, if no appeal be taken, a rehearing or bill of review will be available in the lower court. In patent cases on the equity side the primary and essential contention relates to the ownership of the patent, the validity of the claims, and the infringement; and final adjudication in favor of the complainant on this contention is a perpetual injunction. One portion of the decree may be final, and for that reason appealable, while the remainder may be interlocutory and not appealable.

Affirmance of Decree.—There is no power in the Court of Appeals to affirm a decree of the lower court, and thus give a finality to that decree which it did not have when it was entered of record below.

Proof of Assignment of Patents.—Certified copies of the assignments of patents in the Patent Office is prima facie evidence that the original assignments were made in terms as shown in the record, that such assignments were subscribed as shown, were delivered, the signatures were genuine, and that the assignor had an assignable interest.

The force of the above points in this case, however, is greatly weakened by dissenting opinions.

#### BRITISH MINERAL INDUSTRY.

The report to the Home Office on the mineral industry of the United Kingdom shows that coal mining gave employment in 1895 to 687,371 persons above and below ground; that 16,087 persons are employed at iron mines, and 30,199 persons at other mineral mines. In 1895 there were 189,661,362 tons of coal raised, a slight advance on the figures for 1894; but the value of the product at the mines fell to £57,231,213, from £62,730,179. Iron ore comes next, with 12,615,414 tons raised, worth £2,865,709. As with coal, the quantity raised was larger than in 1894; the selling value was less. Lead ore was of higher value in 1895, although the amount raised was less. Tin ore shows a decline under both headings. There were 13,266 tons of gold ore raised, with a value of £16,584, as against 6,603 tons in 1894, worth £13,573. The increase in the amount of coal raised was entirely due to the greater activity in the Scotch mines. But in 1894 nearly all the Scotch collieries were idle for some months in consequence of a strike.

It is an interesting question how long the enormous drain on our coal mines can go on without exhausting the supply, says the London Times. The late Professor Jevons, assuming that the average annual rate of growth of our coal consumption would be 3½ per cent, calculated that by 1970 we should have exhausted the whole available coal in the country. Since 1873, however, the actual output of coal has never been as great as it would have been at the assumed rate of increase. There are, too, other factors in the problem. Sir Robert Giffen has shown that for the finer industries, and with improved manual skill, a small amount of coal will do the full work which, under other conditions, it would need a much larger amount to do, so that a shrinkage in our coal supply and a decline in our industrial progress will not necessarily come together. Nor is it certain as yet what our coal resources may prove to be. In 1895 there were 1,016 fatal accidents in and about the mines and quarries of the United Kingdom, causing a loss of 1,198 lives. There was an increase of 62 in the number of fatal accidents and a decrease of 77 in the number of deaths. In coal mining "falls of ground" cause nearly one-half of all the deaths underground. This form of accident is to a large extent preventable by a more systematic use of timber for support at the working face of the mine. Explosions are also to be set down as largely preventable. The men continue to take pipes, matches, and appliances for unlocking safety lamps into the mines; and there are, the report says, mine owners who do not introduce safety lamps where they are absolutely needed, and magistrates who persistently refuse to punish negligence and breach of rule.

THE Franklin Institute of Philadelphia announces the award of the following John Scott Legacy medals and premiums: William S. Burroughs, of St. Louis, for his calculating machine; Emile Berliner, of Washington, for his gramophone; Edward Brown, of Philadelphia, for improvements in pyrometers; Dr. W. C. Roentgen, for his investigation of a new kind of rays; Dr. Elisha Gray, for his telautograph; Pedro G. Salom and Henry G. Morris, of Philadelphia, for their automobile vehicle. The Elliott Cresson medal has been awarded to Hamilton Y. Castner, of Oldbury, for his electrolytic process for caustic and bleach.

**A BAROMETER AND STORM ALARM.**

A barometer designed to automatically sound an alarm when there is a very sudden change in the atmospheric pressure, such as occurs in advance of any very violent storm, is represented in the accompanying illustration, and has been patented by William T. Flournoy, of Marionville, Mo. The instrument is practically a tornado, cyclone and storm indicator, and, as tested, has been found to give an alarm some two minutes before the first blasts of the storm occur. In the engraving the main mercury tube is represented with a cylindrical bulb at the top, and connected with the main tube, near the lower portion of

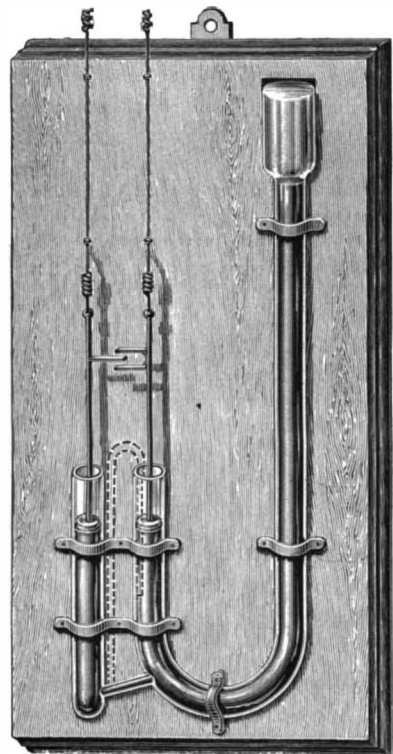

**FLOURNOY'S BAROMETER AND STORM ALARM.**

nearly equal height in ordinary changes of the weather, but in case of sudden atmospheric change the small opening in the connection between the tubes restricts the movement in the secondary tube as compared with that in the main tube. Such variation in the movement of the mercury in the two tubes, when sufficient to indicate an approaching storm, is made to give an alarm, by means of floats in the tubes connected with wires in an electric circuit, there being on one wire a fork and on the other a tongue, by which contacts are made, to ring an alarm when the points meet. It has been found by experience that the instrument will not give an alarm except in case of a storm of great violence, the mercury columns remaining nearly even, and giving no alarm, when the storm is of an ordinary character.

**A PIPE PLUGGER AND FLUSHER.**

A device designed to facilitate the flushing or plugging of sewer and other pipes is shown in the accompanying illustration, and has been patented by Clarence B. Brenneman, of Marion, Iowa. The device has a hollow, bulb-like metallic core, with openings in its walls, adapted to be engaged on the outside by a bulb of rubber or other suitable flexible material, the ends of the bulb being secured on the core by walls

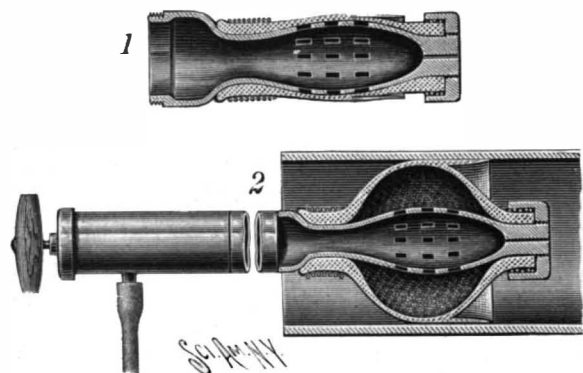

**BRENNEMAN'S PIPE PLUGGER AND FLUSHER.**

formed of thicker portions and the outer end being protected by a cap. One end of the core is connected with a source of fluid supply, and fluid forced into the core, passing through its side openings, distends the flexible bulb. Fig. 1 shows the device with the bulb deflated, and Fig. 2 represents the improvement as applied, with the bulb distended. In the outer end of the core is an outlet for discharging fluid under pressure into the sewer pipe, and on the outside of the forward part of the flexible bulb is an annular flange which rests tightly against the inner surface of the sewer pipe when pressure is thus applied, making a se-

cure joint between the device and the pipe. When the device is to be used as a plug to seal one end of a pipe, the opening at the outer end of the core is closed by suitable means previous to insertion in the pipe. The device may also be used for various other purposes, as the closing and sealing of bottles and other receptacles.

**AN IMPROVED WRENCH.**

The illustration represents a simple and efficient wrench which may be quickly and easily adjusted to a nut of any size and its jaws firmly locked in adjusted position. It has been patented by William Vessey, of No. 210 Water Street, Sandusky, O. The small figure is a longitudinal sectional view. A sleeve, open at its front end, slides on the shank back of the movable jaw, and the latter is connected with the sleeve by an arm, the connection being made by a pin, while beyond this arm the end of a lever is pivoted in the upper portion of the sleeve, the lever having on its under face teeth adapted to engage the teeth on the shank of the wrench. A spring connects the lever with the front portion of the arm connected with the movable jaw, and hinged to this spring is a wedge adapted to enter the space between the arm and the lever. When the spring and wedge are moved outward, the movable jaw may be readily moved along the shank in either direction, but when the jaws have been brought into engagement with an object, the lever is carried down until its teeth engage those of the shank, the wedge at the same time entering the space between the arm of the sliding jaw and the outer end of the lever, forming a firm locking engagement.

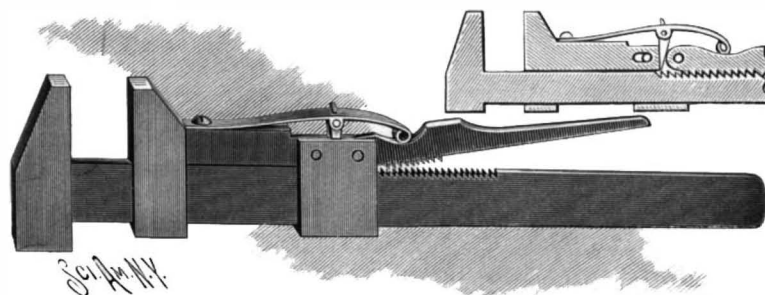

**VESSEY'S WRENCH.**

**Remarkable Long Railroad Record.**

A special train from Chicago over the Chicago, Burlington and Quincy and the Burlington and Missouri Railroads reached Denver at 3:52 A. M. February 16, having traveled 1,026 miles in eighteen hours and fifty-two minutes. This journey goes into history as the greatest railroad feat ever accomplished.

On straight stretches of track the train covered more than sixty miles an hour. The mountain climb from Akron, Col., to Denver, 118 miles, was made in 124 minutes, the train running an even mile a minute much of the distance.

The train making this run was chartered by Henry J. Mayham, a broker of Denver. His son, William B., was dangerously ill, and Mr. Mayham made a desperate, though unsuccessful, effort to reach Denver before the young man's death. The Burlington officials agreed to take him to Denver from Chicago in twenty-four hours. They cut down their own estimate five hours.

The following table gives a complete record of the Burlington special's fast trip from Chicago to Denver:

Miles.	Station.	Time of departure.	Time of running, minutes.
...	Chicago	*	..
206	Burlington	1:51 P. M.	281
248	Glendale	2:37 P. M.	277
282	Ottumwa	3:18 P. M.	318
306	Albia	3:47 P. M.	347
332	Charlton	4:22 P. M.	382
396	Creston	5:26 P. M.	446
447	Red Oak	6:20 P. M.	507
482	Pacific Junction	7:07 P. M.	547
538	Lincoln	8:14 P. M.	614
634	Hastings	10:04 P. M.	724
711	Oxford	11:24 P. M.	804
765	McCook	† 12:15 A. M.	955
908	Akron	1:48 A. M.	1,008
998	Brush	2:14 A. M.	1,034
982	Roggen	3:02 A. M.	1,082
1,026	Denver (arrived)	3:52 A. M.	1,132

\* Central time. † Mountain time.

To realize what such a flying trip means, it might be well to compare the run with some of the long railroad runs that are looked upon as record makers.

The New York Central and Hudson River Railroad claimed to hold the record until recently, with the trial trip made from New York to Buffalo on September 14, 1891. The train consisted of an engine and two Wagner palace cars and a Central private car, and weighed altogether about 460,000 pounds.

The run from New York to Albany, 143 miles, was made without a stop in 140 minutes; that of 148 miles from Albany to Syracuse in 146 minutes, and that from Syracuse to East Buffalo, 146 miles, in 147 minutes 34 seconds.

Including the stops, the whole time of the trip was 439½ minutes and the distance 436½ miles, or a trifle less than 60 miles an hour. Since then this road made a new record, on September 11, 1895, when, with a train weighing 361,000 pounds, the same run was made in 6 hours 51 minutes and 56 seconds, at an average speed of 63.54 miles an hour.

The Lake Shore and Michigan Southern Railroad claims to have beaten this on October 24, 1895, with a

special run from Chicago to Buffalo, a distance of 510.1 miles, with a train weighing 304,500 pounds.

The trip was divided into five stages, and the first, of 87.4 miles, was made at the rate of 61.38 miles an hour; the second, of 133.4 miles, at the rate of 64.24 miles an hour; the third, of 107.8 miles, at 60.96 miles an hour; the fourth, of 95.5 miles, at 66.99 miles an hour; and the fifth, of 86 miles, at an average rate of 72.91 miles an hour. The total distance was covered in 8 hours, 1 minute and 7 seconds, actual time from station to station, which gave an average speed, including stops, of 63.61 miles an hour.

Remarkable as these results were, it would not be

fair to compare them with a run of twice the distance of the longest of them, for as distances increase, the difficulties of making high speed also increase. Grades, adverse winds, bad pieces of track, and all the other elements which work against high continued speeds multiply usually in a sort of geometrical progression to make difficulties.

To give some idea of this, the greatest runs which the New York Central and Hudson River Railroad has recorded for trips across the continent will offer a fair basis of comparison.

The fastest of these was one with the China and Japan mails from Vancouver to New York by way of the Canadian Pacific, the Rome, Watertown and Ogdensburg and the New York Central and Hudson River roads.

The distance traveled was 3,212 miles, and the time was 3 days, 12 hours and 42 minutes, or an average speed of 37.9 miles an hour.

**A VERY CONVENIENT FAUCET.**

A faucet with which one may, by one movement of its plunger head, draw either hot or cold or warm water, and readily lock the faucet open in the desired position, is shown in the accompanying illustration, and has been patented by George T. Kenly, of Lake Montebello, Baltimore, Md. The cylindrical valve or piston of the faucet has opposite arc-shaped longitudinal delivery channels, as indicated in the small figure, to afford water communication between its upper and lower ends, and the piston is kept normally at the top, or in closed position, by a coiled spring, as shown in the broken-away portion of the main view. The other three figures show the position of the valve when it is depressed as necessary in drawing either hot or warm or cold water.

To hold the piston or valve open, that the water may run without the valve being held down by hand, a series of pivoted bails of different lengths are arranged to be moved into engagement with the top of the plunger. The faucet may be fitted in the floor and worked by foot pressure, if desired, leaving the top of the basin free. It has also been patented in Canada and many foreign countries.

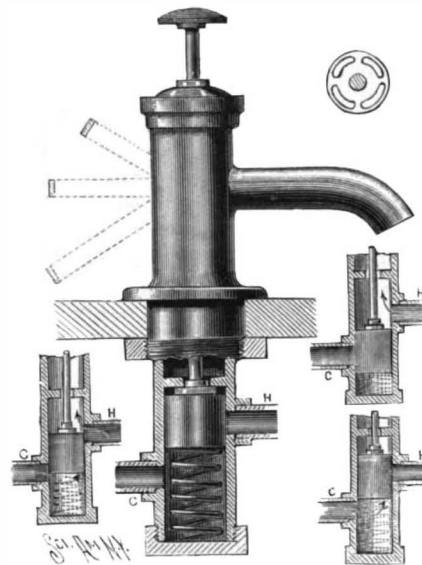

**KENLY'S FAUCET.**

An appeal is being made to the men of wealth in America to provide a suitable building for the societies composing the Scientific Alliance of New York. The combined membership of these societies is now over one thousand. Nearly all of them issue valuable publications; several of them possess important libraries and growing collections of specimens, and all are actively engaged in promoting original research. Burlington House partly provides for London scientific societies, but there is no building of like character in New York, though it is hoped that one will be provided by the enlightened liberality of private citizens.



**OPENING OF THE NEW YORK CENTRAL FOUR TRACK DRAWBRIDGE AND VIADUCT IN NEW YORK CITY.**

In the early hours of Monday, February 15, connection was made at each end of the magnificent viaduct which will henceforth carry the heavy traffic that enters New York by way of the New York Central and Hudson River Railroad. Our readers are doubtless aware that the New York Central is the only railroad company that possesses a terminus on Manhattan Island. In addition to carrying the heavy through passenger traffic which the vast Vanderbilt system brings to the metropolis, the lines of the company accommodate the large express and suburban traffic of the New York, New Haven & Hartford Railroad, as well as the heavy suburban travel on what is known as the Harlem road. The New Haven and the Harlem trains converge near Mount Vernon, and at Mott Haven their number is swelled by the traffic of the main line, which, turning in from the Hudson River at Spuyten Duyvil, joins the Harlem branch at Mott Haven to the north of the Harlem River. To accommodate all these trains there was formerly a low level two-track bridge across the river, which contained a center pivot drawspan, supplemented by a hinged lifting bridge. For several blocks north and for a shorter distance south of the Harlem River the tracks ran at street grade, and this necessitated low level crossings, which seriously interfered with traffic on important thoroughfares in Mott Haven. The Harlem River, moreover, is a legal waterway, and the small head room

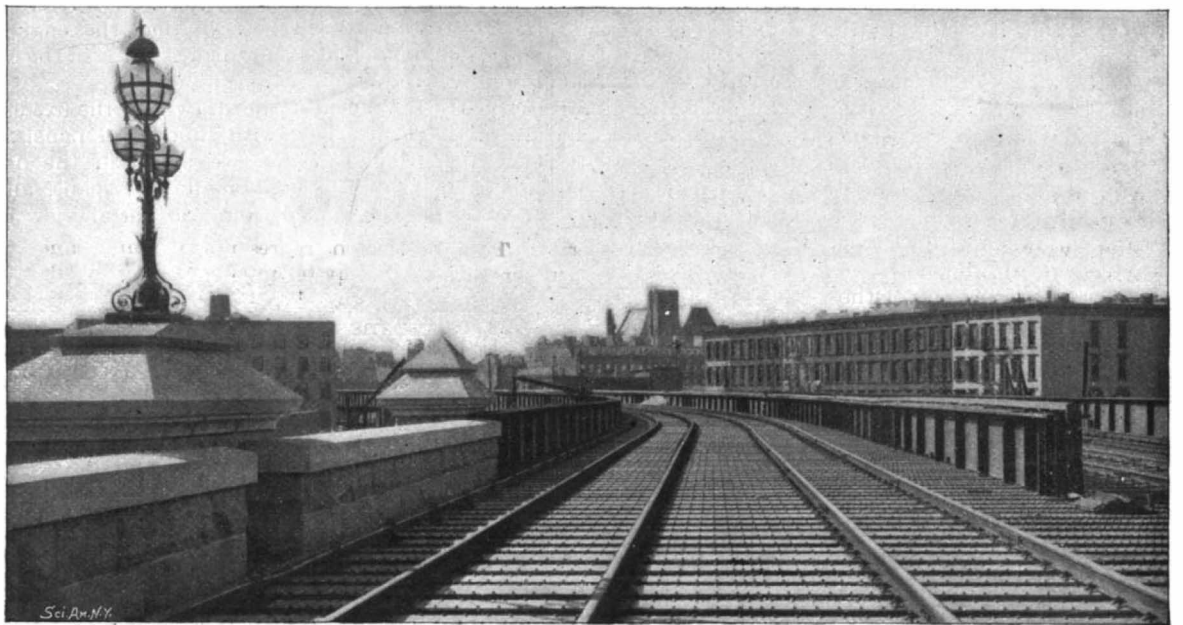

THE CURVE FROM HARLEM RIVER TO PARK AVENUE.

track trestles, one on each of the old tracks, for the purpose of carrying the trains from the high level at which the tracks leave the Park Avenue tunnel at

use during the erection of the new drawspan and the two fixed spans which were to constitute the new crossing. It was also necessary to erect a large number of temporary trusses above the depressed tracks to assist in carrying the floor of the viaduct during construction.

The viaduct is carried upon three rows of latticed columns, the outer row being built on the line of the old retaining walls of the cut and the center row standing on the center line of the old roadbed. The flooring, which is of the well known open box girder type, commonly known as trough flooring, used by the company on its bridges, is carried by three rows of longitudinal plate girders, which are generally 7 feet 2 inches deep, with a  $\frac{3}{8}$  inch web for the outside girders and a  $\frac{1}{4}$  inch web for the center row. The trussed flooring is riveted to the plate girders, the "troughs" or channels running, of course, across the bridge, and the rails are fastened with clips directly to the flooring, insulating material being interposed between the rail base and the metal to deaden the sound. The columns are spaced 65 feet between centers longitudinally and 28 feet between centers measured across the viaduct, the total width of the floor being 56 feet. Lateral stiffness is provided by a transverse lattice girder at each set of columns, and the whole structure is further stiffened by the method of attaching the flooring to the girders and by deep knee braces at the tops of the columns.

The erection of the viaduct as far north as One Hundred and Fifteenth Street presented no special difficulties, the foundations being built and the columns set up on the site of the abandoned tracks; but north from One Hundred and Fifteenth Street the trains had to run over the old tracks, and while the outer row of columns could be built on the site of the side walls, there was no room for the erection of the center row of columns. In order to carry the center girders, temporary wooden trusses were thrown across the tracks, the ends of the trusses being carried by the side walls of the cut, or, where the tracks were at street grade, by wooden piers. The arrangement is clearly shown in the accompanying woodcut. These trusses alone

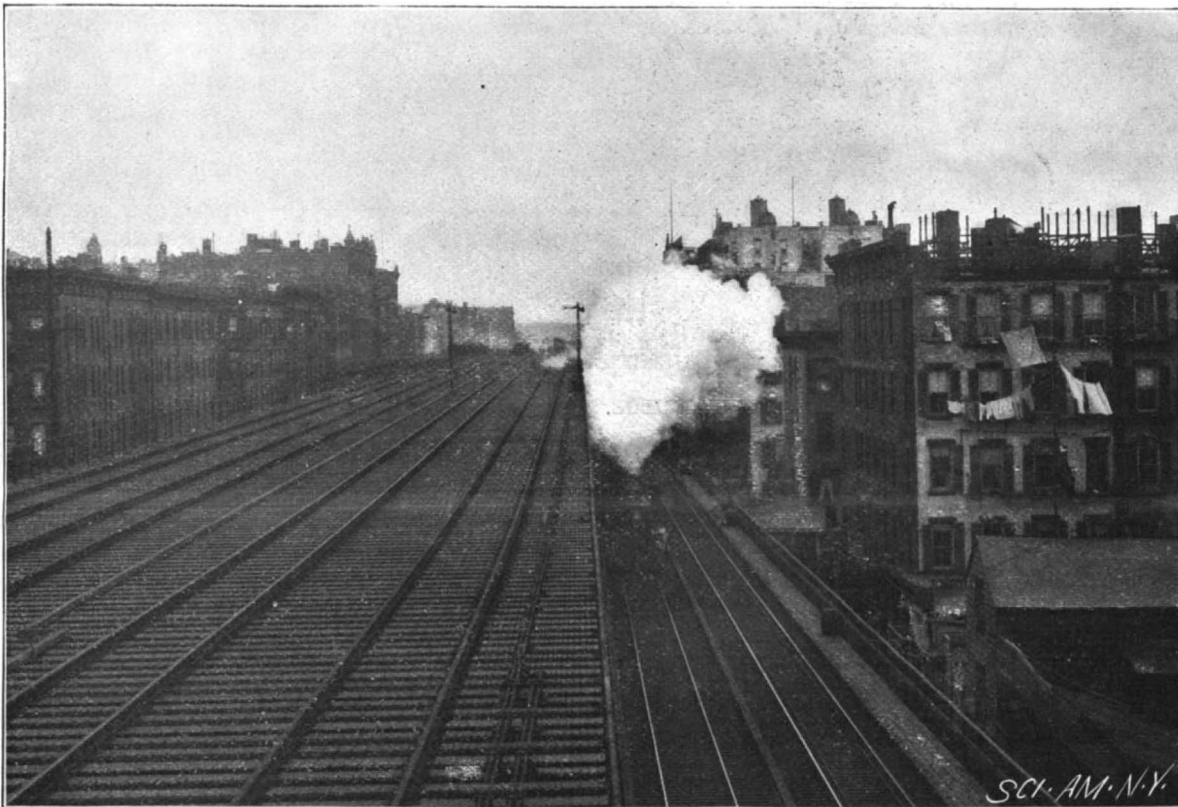

THE VIADUCT AND TEMPORARY TRACKS NORTH FROM ONE HUNDRED AND TENTH STREET STATION.

beneath the drawspans necessitated frequent openings, which were a constant interruption to traffic both on rail and river. Nor was this all. On the south side of the river the tracks ran through the center of Park Avenue in a cut of varying depth, which necessitated blocking off the through vehicular traffic on streets which in common with this section of Park Avenue had developed a considerable amount of traffic in the later years of the city's growth. From this it will be seen that the old arrangement was a constant source of delay and annoyance to traffic, whether on the rail, the river, or the streets.

The remedy adopted was worthy of the traditions of the New York Central Railroad. It was decided to build a high level, four track steel viaduct over two miles in length through the district in question, and span the Harlem with a massive four track drawbridge, which should give two clear openings of 100 feet each for the passage of the larger vessels and provide when closed a sufficient headway for smaller craft to pass under. This would abolish the street grade crossings and leave the whole width of Park Avenue, for the distance affected, free of all obstructions except the three lines of columns which carried the viaduct.

Now this work as projected involved the construction of the heaviest drawbridge in the world and over a mile of massive viaduct, at a total outlay of \$3,000,000—a large and costly undertaking; but the difficulty of the work was greatly increased by the fact that it was necessary to carry out the whole of it without interfering with the traffic of a great four track railroad or the waterborne traffic of an important waterway. No greater tribute could be paid to the skill of Col. Katté, the chief engineer of the railroad, and his corps of assistants than is given by the fact that this was done without a single interruption that could be charged to the plans of reconstruction.

The temporary work consisted in building two two-

Ninety-eighth Street down to the grade of the old tracks at about One Hundred and Fifteenth Street, and it was also necessary to build a temporary crossing over the Harlem River to the west of the existing bridge for

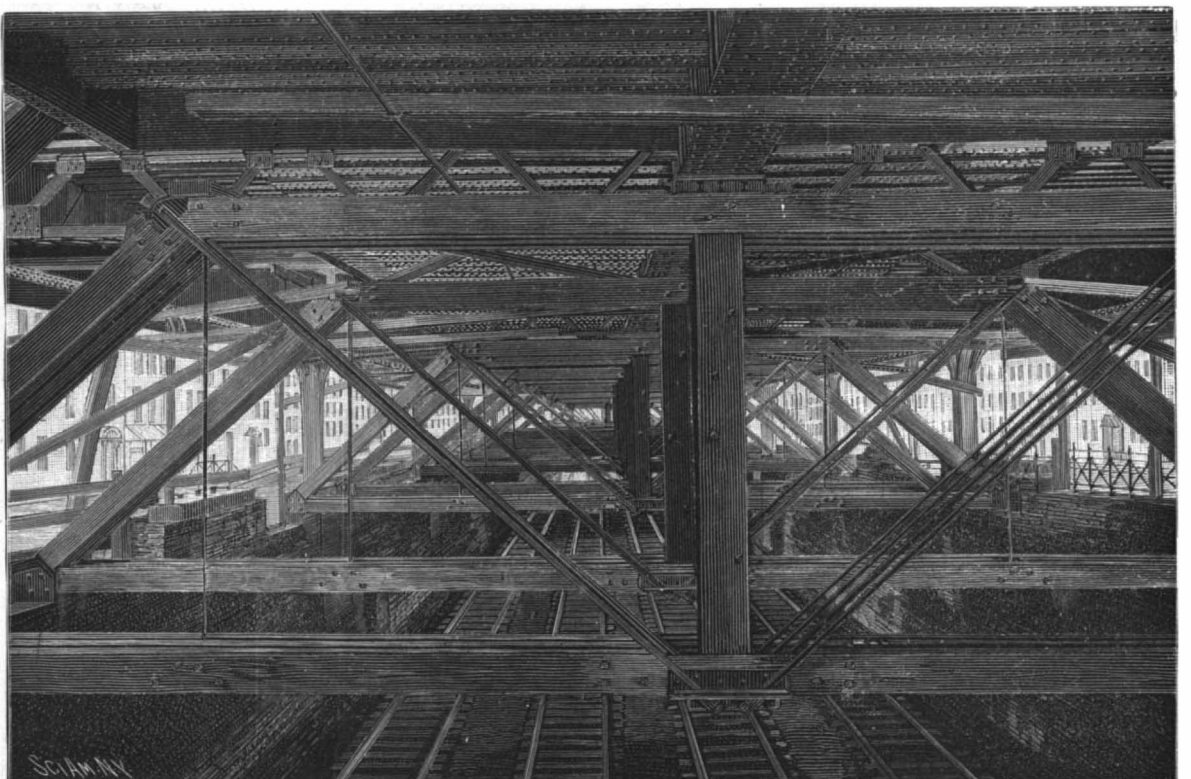

TEMPORARY TRUSSES UNDER THE VIADUCT—OLD TRACKS BELOW.

THE NEW YORK CENTRAL FOUR TRACK STEEL VIADUCT, NEW YORK.

were a large source of expense, as they were placed beneath the viaduct for a distance of several thousand feet and had to be made strong enough to carry one-half the weight of the floor and the traffic. Now that the depressed tracks are abandoned, the steel columns will be put in place between each pair of trusses and the trusses removed.

The great 400 foot four track drawspan over the Harlem River is the most striking feature of the whole work, and taken with the two fixed spans to the north of the draw, it forms one of the handsomest specimens of bridge design in New York City. It can well be understood that to provide a stable and perfectly level platform upon which this great mass of 2,500 tons should rotate called for specially heavy foundations. The center pier rests upon 700 piles, which were driven to a depth of 54 feet below high water, the distance between centers being  $2\frac{1}{2}$  feet. The piles were cut off to one level and 1,200 yards of concrete were filled in between them and finished off flush with their heads. Upon this was placed  $6\frac{1}{2}$  feet of timber grillage, the surface of the latter being below high water and forming the foundation for the masonry work of the pier. This is built in an annular form and consists of a central portion beneath the central pivot and an outer circular wall beneath the rollers, the two portions being tied together with six radial walls.

The weight of the draw is carried upon two concentric drums which are strongly braced together and are respectively 46 and 54 feet in diameter, the inner drum being 5 feet  $11\frac{1}{4}$  inches deep and the outer 5 feet 10 inches deep. If the great weight of the draw had been transferred directly to the drums by the bottom chords, it would have brought too great a concentration of weight on the rollers at certain points, and in order to give an even distribution of weight, eight massive distributing girders, nearly 6 feet deep, were placed across the drums at right angles to the center line of the bridge and the load was transferred to them by four raising girders, two extending longitudinally under the middle truss and one under each of the side trusses. There are 72 cast steel rollers beneath each drum, the outer set being 24 inches and the inner set  $20\frac{7}{8}$  inches in diameter, the faces being  $10\frac{1}{2}$  inches wide in both cases. There is a cast steel center pivot provided, which carries a massive collar to which the radial struts which keep the drums and rollers in their true path are attached. No weight is carried by the center pin. The cast steel rack with which the mechanism for turning the drum engages is of  $4\frac{1}{2}$  inch pitch and has a 10 inch face. For turning the draw a duplicate set of engines and boilers is provided, one set only being ordinarily in use. The engines, which have cylinders 10 inches in diameter by 7 inches stroke, were made by Edwards & Company, of New York.

In order to prevent hammering by the free or unloaded end when a train enters the drawspan, provision is made for transferring about 200 tons of the weight to the end piers. This is done by means of a powerful system of levers acting on the principle of a toggle joint, which are carried at the ends of the draw and operated by

shafting from the turning engines. By reference to the illustration it will be seen that the engines are housed upon a platform which is built in the central tower over the pivot pier.

The trusses, both of the draw and the fixed spans, are of the Pratt type, with subdivided panels. The trough flooring of which we spoke in the description of the viaduct is used on all three spans, and the effect, as may be judged from the portal view of the

long and the river span 185 ft.  $4\frac{1}{2}$  in. long, their depths being respectively 26 ft.  $3\frac{1}{4}$  in. and 30 ft.  $10\frac{1}{4}$  in. The drawspan is 400 ft. long over all and 389 ft. between end pins. Its breadth from center to center of outside trusses is 58 ft. 6 in. Between these trusses are two clear ways, each 26 ft. wide, and each carrying two tracks. At the center of the draw-bridge the trusses are 64 ft. deep center to center and at the ends 25 ft.

Limitations of space forbid any detailed reference to the size of the members in the drawspan, but it may be mentioned that the steel pin in the center truss at the pivot pier is 12 inches diameter, and that the eight tension members extending from the top of the tower to the hips of this truss represent a mass of metal whose cross section is nearly a square foot of steel.

In addition to the massive bridge work, which of course forms by far the heaviest and most costly portion of the work, it has been necessary to make extensive changes in the platforms and general accommodation of the three stations which are affected by the alterations. These occur at One Hundred and Tenth Street, One Hundred and Twenty-fifth Street and at Mott Haven. It has been necessary in every case to raise the platforms to the level of the new tracks, and we present illustrations of the viaduct at One Hundred and Twenty-fifth Street showing how the problem has been worked out at this point. It will be seen that the waiting rooms, ticket offices, etc., have been built at street grade and beneath the floor of the main viaduct.



WEST ABUTMENT OF THE HARLEM RIVER BRIDGE.

drawspan, is to give the bridge an appearance of great strength and solidity. The use of the trough flooring necessitated the substitution of a deep plate bottom chord on all three spans in place of the eye-bars or shallow box chords which are usual in this form of truss. The plate flooring brings a bending strain upon the bottom chord between the panel points, to resist which the bottom chord was given that noticeable depth which is a striking feature of this handsome structure.

Of the two fixed spans, the shore span is 131 ft.  $4\frac{1}{4}$  in.

The two interior express tracks are located, as usual, on each side of the central longitudinal girder. The spaces between these tracks and the outside girders are taken up by two platforms  $15\frac{1}{2}$  feet wide, which do duty for all four tracks. To carry the local tracks it has been necessary to widen the viaduct to 82 feet, build an outer line of girders 12 feet from the main viaduct, and support it by transverse plate girders, whose outer ends are carried by columns located on the curb of the sidewalks.

The steel viaducts were built by the Elmira Bridge Company and the New Jersey Iron and Steel Company, at a contract price of \$1,500,000. The Harlem River crossing, of which the drawspan and two fixed spans were built by the King Bridge Company, of Cleveland, O., cost, with its foundations, \$1,000,000. The work at Mott Haven cost \$500,000, the masonry work of the viaduct piers \$100,000, the temporary tracks \$100,000, making a total cost for the whole undertaking of over \$3,000,000.

We are indebted for our information to the courtesy of Mr. Walter Katté, chief engineer of the New York Central, and to Mr. George E. Gifford, C.E., the Eastern representative of the King Bridge Company.

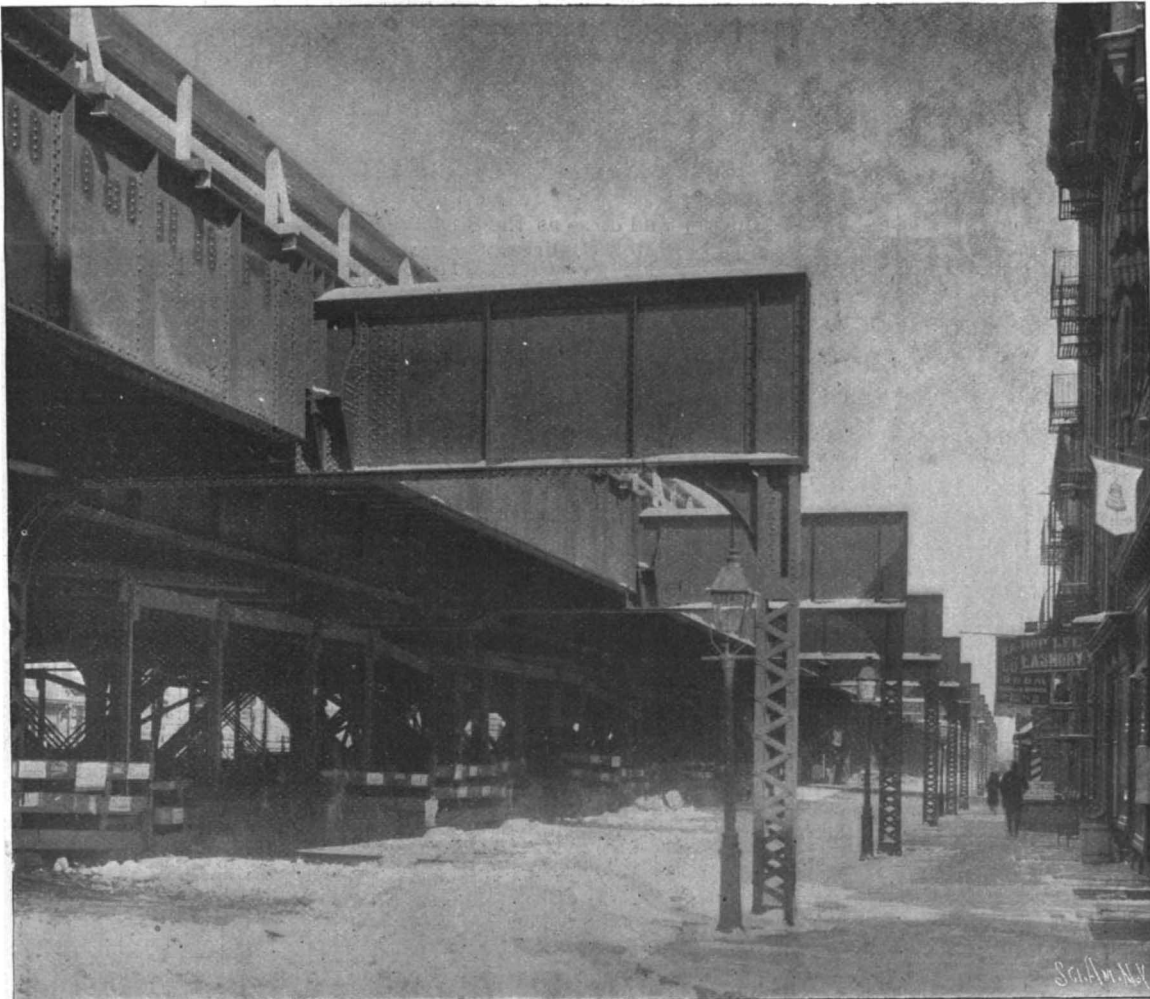

AUXILIARY GIRDERS FOR CARRYING LOCAL TRACKS AT ONE HUNDRED AND TWENTY-FIFTH STREET STATION.  
THE NEW YORK CENTRAL FOUR TRACK STEEL VIADUCT NEW YORK.

A MACHINERY exhibition will be held in Munich, Bavaria, from June 1 to October 10, 1898, to which manufacturers of motors and machine tools of all countries are invited. The General Industrial Association of Munich celebrates by this exposition its fiftieth jubilee, and will have the co-operation of the Polytechnic Association and also the patronage of Prince Luitpold, Regent of Bavaria.



## Science Notes.

Dr. Nansen, the Arctic explorer, delivered a lecture in Christiania on January 27, in the course of which he said that the best course to take to get to the North Pole was from Behring Sea toward the north-northeast, afterward drifting with the ice current, which would be certain to lead to Greenland.

It has recently been discovered that iodine exists in combination in the human body. It occurs in the thyroid gland, and may be concerned as the essential chemical substance in the internal secretion of that gland. The proof of the occurrence of iodine in the living structure of animals is of great scientific interest and importance, says Knowledge, and is the most remarkable discovery made by chemical physiology for some time.

The technical library of the late Eckley B. Coxe has been given by his widow to Lehigh University, and will constitute an important addition to the equipment of that institution, says the Electrical Review. The library numbers about 8,000 volumes, and comprises also the complete library of Julius Weisbach, whose pupil Mr. Coxe was in Freiberg, and whose work on mechanics Mr. Coxe translated into English. A fine oil painting of Weisbach accompanies the library.

Dr. E. Oddone has recently examined the seismic record of Liguria during the last century (1796-1895), in order to determine whether the frequency of earthquakes in that district is subject to any periodic laws, says Nature. The record is a non-instrumental one, and the results derived from it have not therefore the same value as those obtained from a seismometric catalogue. Dr. Oddone shows that the supposed nocturnal prevalence of earthquakes is here insensible, but there is a daily period with its maximum between 6 and 7 A. M. The two halves of the century do not exhibit the same distribution of earthquakes throughout the year, and in the latter half (during which the record is most complete) earthquakes are equally numerous in the summer and winter months. They are less frequent during years of maximum solar activity, and vice versa, so that there appears to be a period of eleven years, and possibly also one of about twice this length.

It is not generally known that in chemical analyses different results, in many cases, are obtained by different chemists from the same substance. Thus, according to a paper read by F. P. Dewey, of Washington, D. C., before the American Institute of Mining Engineers, this fact was illustrated, notably in a case of examination of gold and silver in copper materials—a case in which there were twenty-six results by twenty chemists, working by two main methods, each by a single chemist, varying from 135.38 to 122.88, and averaging 127.94 ounces per ton, the extreme variation being 12.5 ounces per ton, or 9.77 per cent of the average determination. In the silver assay of the copper borings, nine chemists' reports by the scorification method averaged results varying from 164.35 to 154.40, the rate per ton running some 159.36 ounces, thus showing an extreme variation of 9.95 ounces per ton, or 6.24 per cent of the average. Further, fifteen chemists' reports of sixteen results by combined wet and scorification methods varied from 161.40 to 148.50, averaging 156.48 ounces per ton, the extreme variation being 13.9 ounces per ton, or 8.88 per cent of the average. Summing up, there are thus shown twenty-six determinations by twenty chemists, working by three methods, ranging from 164.35 to 148.5, and averaging 157.67 ounces per ton, the extreme variation being 15.85 ounces per ton, or 10.05 per cent of the average determination.

Some experiments with Roentgen radiation have recently been carried out by Prof. Threlfall and Mr. Pollock. Some particulars of these were given at a recent meeting of the Physical Society, says the Engineer. The authors describe a form of Crookes tube which, while it can be made by anyone capable of the most elementary glass blowing, gives a plentiful supply of Roentgen rays. The results of their experiments are summed up as follows: 1. The Roentgen radiation does not consist in the projection of gaseous matter; or, if it does, the amount of such matter involved is extraordinarily small. 2. The Roentgen radiation does not consist in the projection of ether streams having a velocity above a couple of hundred meters per second; this is true, whether the radiation takes place in air or in benzene. 3. The properties of the ether regarded as determining the velocity of electromagnetic waves are not greatly changed—i. e., not at all within our experimental limits—by the Roentgen radiation; and this applies alike to the ether in air and in benzene. 4. A selenium cell composed of platinum electrodes and highly purified selenium is affected by Roentgen radiation to an extent which is comparable with the effect produced by diffused daylight. 5. No permanent or temporary electromotive force is set up in a selenium cell by the Roentgen radiation. The authors have come to the first conclusion by exposing an exhausted tube placed in parallel with a spark gap, so adjusted that the spark just passes over the gap rather than through the tube, to the Roentgen radiation. They find that a vacuum tube in parallel with a spark gap is very sensitive to changes in pressure within the tube.

## The Stevens Institute Celebration.

The twenty-fifth anniversary of the founding of Stevens Institute was inaugurated on the evening of February 18 by a dinner at the Hotel Waldorf. There were present a large number of invited guests. Ex-Mayor Hewitt was introduced as the first speaker.

"I suppose I am the only one in this room, if not in the country," he said, "who has seen all the members of the Stevens family, from the head of the family of revolutionary fame down to his grandchildren and great-grandchildren of the present day. This may seem a strange statement, but when I was five years old I was standing at the foot of Jay Street with my father when I saw a steamboat going up the Hudson River. I asked my father whose it was, and he took me across the river to Hoboken and introduced me to John Stevens, the owner, then 83 years old. Mr. Stevens was in possession of all his faculties and interested in all my father had to say to him. John Stevens saw the first engine ever set up in this country. It was brought here from England, but Mr. Stevens built the first engine in this country, and it was placed in a steamboat which traversed a route from Belleville to New York nine years before Fulton launched the Clermont and started it on the Hudson. I traveled on this ferry, and John Stevens was on the boat.

"My next recollection of the Stevens family was when I was a student at Columbia College, then away down town. We played baseball then. It was the only game we had, and not such a detriment to a college as it is to-day. We lost most of our baseballs by knocking them over into the yard of a house in Barclay Street. One day, when we were short and could not get any baseballs, I was appointed a committee of one to visit the house and ask for some. A gentleman appeared in answer to my question, and, producing a basket containing twenty-five or thirty baseballs, asked me if they were ours. I said I supposed they were. 'Well,' he said, 'every one of those balls has broken a window in my house. You may take them, and when you have all the windows in my music room broken come over to Hoboken and there you shall have a fair field.' That man was the greatest mechanical engineer, the greatest naval engineer, the greatest railroad engineer which the nineteenth century has produced—Robert L. Stevens. [Cheers.]

"In 1846 Edwin Stevens came to me and asked me to make him 2,000 tons of steel rails. Material was so enormously high priced in those days that it was impossible to import the rails from abroad. My friend, Mr. Carnegie, will lick his chops when I tell him what the price was. [Laughter.] Mr. Stevens told me he would pay the lowest price quoted in the foreign market, with the duty included, which amounted to \$90 a ton, and at the latest quotations whispered to me by my friend Carnegie, 10,000 tons can be bought for this amount to-day. John, Robert, and Edwin Stevens worked as one man, and attended personally and minutely to everything they did, and there was—I say this for the benefit of you young men—never a quarrel of any sort between them.

"One has to go back as I do, when there were no steamboats, no steamships, no railways, no telephones, no telegraph, when this State beyond the Mohawk Valley was not traversed, and when this great empire was a wilderness, to appreciate what the Stevens family has done for this country. You gentlemen are reaping the fruits of what they have sown. You will attend to your business, try to make money and succeed in life, but try and do so as the Stevenses did, by throwing sunshine into the lives of everybody they came in contact with. I know the Stevens family for sixty years, and there never was a strike in any of the industries controlled by the Stevenses. The heads of the family knew personally every one of their workmen, from the highest to the lowest, and could call every one by his first name."

After the conclusion of Mr. Hewitt's speech, which was received with applause, President Morton, of Stevens Institute, read a poem and Mr. Carnegie then made a speech. He was followed by Commodore Melville and President Morton, who also made addresses.

## The Scientific American.

THE SCIENTIFIC AMERICAN, says the Collegian, fills the requirements and demands of those who desire information concerning inventive and applied science. The discussions on problems of electrical transmission and of carriages without horses have economic as well as scientific aspects. The descriptions of inventions are graphic and lucid, and in keeping with the genius of the age. The table of the thoughtful and inquiring and inquiring reader must contain this periodical.

The Williamette Collegian reflects the opinion of a large number of educational institutions who are regular subscribers of this paper and other of our publications. "Experimental Science" is in general use in colleges as a work of reference.

SAEKKINGEN, in Baden, will erect a monument to Scheffel, the student poet whose "Tompeter von Säckingen" made the town famous.

## Archæological News.

After ten years of antagonism, Flinders Petrie has become reconciled with the Egypt Exploration Fund Society, accepted a place on its committee, and is going to work under its auspices. He declined, at a recent meeting, to disclose the scene of his next excavations, but it will be in a hitherto untouched region and connected with the period of the Libyan invasion that took place three thousand years before the Christian era.

In the Architectural Record for the quarter ending March 31, 1897, is a very interesting article by Prof. W. H. Goodyear on "Constructive Asymmetry in Mediæval Italian Churches." This article is possibly even of more interest than those which have preceded it. It is accompanied by a number of careful ground plans and sections of Italian churches and cathedrals. These plans and sections are the result of the Brooklyn Institute Survey, led by Mr. Goodyear, and show an enormous amount of labor, and archæological knowledge of a high order. It is gratifying to note that Mr. Goodyear's researches are being widely known and recognized.

At a special meeting of the Archæological Institute of America, held in New York City, on Saturday, January 30, says Architecture and Building, Prof. John Williams White, of Harvard University, was chosen president in place of President Seth Low, resigned. The scheme for a joint publication presented by the managing committees of the schools of classical studies at Athens and in Rome was approved in general. The new publication will be issued as a continuation of the present series of the American Journal of Archæology, which has been edited and published for eleven years by Profs. Frothingham and Marquand, of Princeton. The editor-in-chief is to be Prof. John H. Wright, of Harvard. The initial number of the new publication will be the first report of the School of Classical Studies in Rome, by Prof. Hale, of Chicago University.

In the Prussian budget a sum of 500,000 marks is provided as an installment toward the cost of erecting a new museum in Berlin, which is estimated at 5,850,000 marks. The site selected is the northern part of the island on which the royal palace, the National Gallery, the old museum and various other buildings now stand. The need of an additional museum is manifest to every stranger who visits Berlin. The accumulation of works of art has long outgrown the accommodation provided in the two museums which were completed in 1840. In consequence of the limited space the sculpture from Pergamus cannot be properly exhibited. Many other examples of ancient art may also be said to be entombed, for they are deposited in places which are only dimly lighted. The quantity of Renaissance sculpture is likewise an embarrassment to the curators. As in no other city are so many earnest students of art to be found, it is time some facilities should be allowed to them in their pursuit of knowledge.

At a recent meeting of the Royal Botanic Society, the secretary, Mr. J. B. Sowerby, showed stems of the Egyptian papyrus, from the plant growing in the Victoria water lily tank at the gardens, which has this year attained extraordinary dimensions, forming a clump 7 feet in diameter, with stems 14 feet long and 2½ inches at the base. From the white pith of which the stems are composed the ancient Egyptians made a paper remarkable for its durability—simply slicing the pith up into flat strips and laying them side by side until a sufficient length was obtained. Under pressure the pieces adhered together, forming a perfectly smooth, even sheet, which could be written upon and rolled up without further preparation. He compared paper made in this way, from plants grown in the gardens, with a fragment taken from an Egyptian tomb, and, according to Dr. Birch, at least three thousand years old. The only difference between the two was the darker color of the older specimen. Major Cotton said the plant, though once abundant, was now extinct in lower Egypt.

In a recent issue of the London Times some interesting matters are stated regarding the work in Philæ. The island is being cleared of debris to permit a more careful examination of the ancient monuments, and it has been discovered that the foundations of the main Temple of Isis are laid upon the granite rock, being in some places over 21 feet in depth, and the temple has nearly as much masonry below ground as above. The southeastern colonnade has also its foundations upon the granite, and so far as excavated they are curious if not unique in design. They consist of parallel cross walls some meters high, but varying according to the slope of the rock surface, with large stone slabs placed horizontally upon their tops, and the pillars forming the colonnade are erected upon the slabs. The nilometer is marked in three characters—Demotic, Coptic, and another much older, probably Hieratic, of which a copy has been sent to Berlin for decipherment. A stela was found bearing a trilingual inscription in hieroglyph. No traces have been discovered of any buildings anterior to the Ptolemaic periods. M. De Morgan, director-general of the antiquities department, is engaged upon repairing the great Hall of Columns at Karnak.

**THE PENNSYLVANIA, THE LARGEST FREIGHT STEAMER IN THE WORLD.**

The ever increasing size of the modern cargo steamer is shown by the proportions of the Pennsylvania, of the Hamburg-American line, which is now on the return trip of her maiden voyage to the port of New York. She is in some respects the largest ship in the world, not even excepting the Campania and Lucania, of the Cunard line; for, although the two passenger ships exceed the freighter in some of their dimensions, the displacement, i. e., the actual dead weight of the loaded ships, is less.

	Length.	Beam.	Depth.	Speed.
Great Eastern .....	Ft. 680	Ft. 83 $\frac{1}{4}$	Ft. 58	Knots. 11
Campania .....	600	65 $\frac{1}{4}$	43	22
Pennsylvania .....	560	62	42	14 $\frac{1}{2}$

At first sight it would look as though the extra  $2\frac{3}{4}$  feet of beam and 40 feet of length of the Cunard boats would give them greater displacement, but it must be remembered that these boats are built for speed, and that the bulk of their underwater body is greatly reduced toward the ends, so as to give them a long, sharp entrance and delivery. Moreover, they do not draw so much water as the freighter, whose extreme loaded

draught is 30 feet. for the lighter weight of the high pressure piston. Piston valves are used for the high pressure and intermediate cylinders and a D valve for the low pressure. Steam is supplied by three double ended and three single ended Scotch boilers, using the high pressure of 210 pounds per square inch. The engine and boilers were constructed by the builders of the ship, Messrs. Harland & Wolff, of Belfast, Ireland. They have proved to be highly economical, as may be judged from the fact that the coal consumption is only eighty tons per day for engines of 5,500 horse power. There are forty-five auxiliary engines scattered throughout the ship, among which are included twelve steam winches and eight steam cranes for handling the cargo—none too many, judging from the fact that they may be called upon to load or unload this huge ship in three or four days of twenty-four working hours.

In addition to her enormous cargo capacity, the Pennsylvania has a large passenger accommodation, being able to carry 200 first cabin passengers, 150 second cabin passengers and 1,000 in the steerage. The passenger accommodations are arranged upon the main, upper, awning, saloon and promenade decks. The first class staterooms are on the awning deck and the saloon deck, with a few staterooms on the promenade deck. Forward on the saloon deck is the first cabin

this size it is impossible for the navigating officer to make himself heard, however stentorian his voice, over a ship that is nearly 200 yards long, and orders are signaled by "telegraphs" from the bridge and read by the officers forward and aft.

On her way out the new ship encountered very boisterous weather, and her officers speak of her as having all the proverbial stiffness of a rock, the only effect of the head seas being to reduce her speed, though the difference was far less than would occur in a ship of average size.

**Liability of Owner of Realty for Accidents.**

Truman A. Black recovered judgment in the Westchester County Court against Thomas A. Maitland, for injuries received in passing out of a store owned by defendant, by breaking through a platform constructed of iron and glass, which formed the approach to the door of the premises from the sidewalk. The Appellate Division in Brooklyn has directed a reversal. Justice Bradley, giving the opinion, holds that, as the premises had been occupied by a tenant for some years, and it did not appear that defendant, as landlord, undertook to keep them in repair, and there was no evidence that the platform was not in good condition at the time the tenancy com-

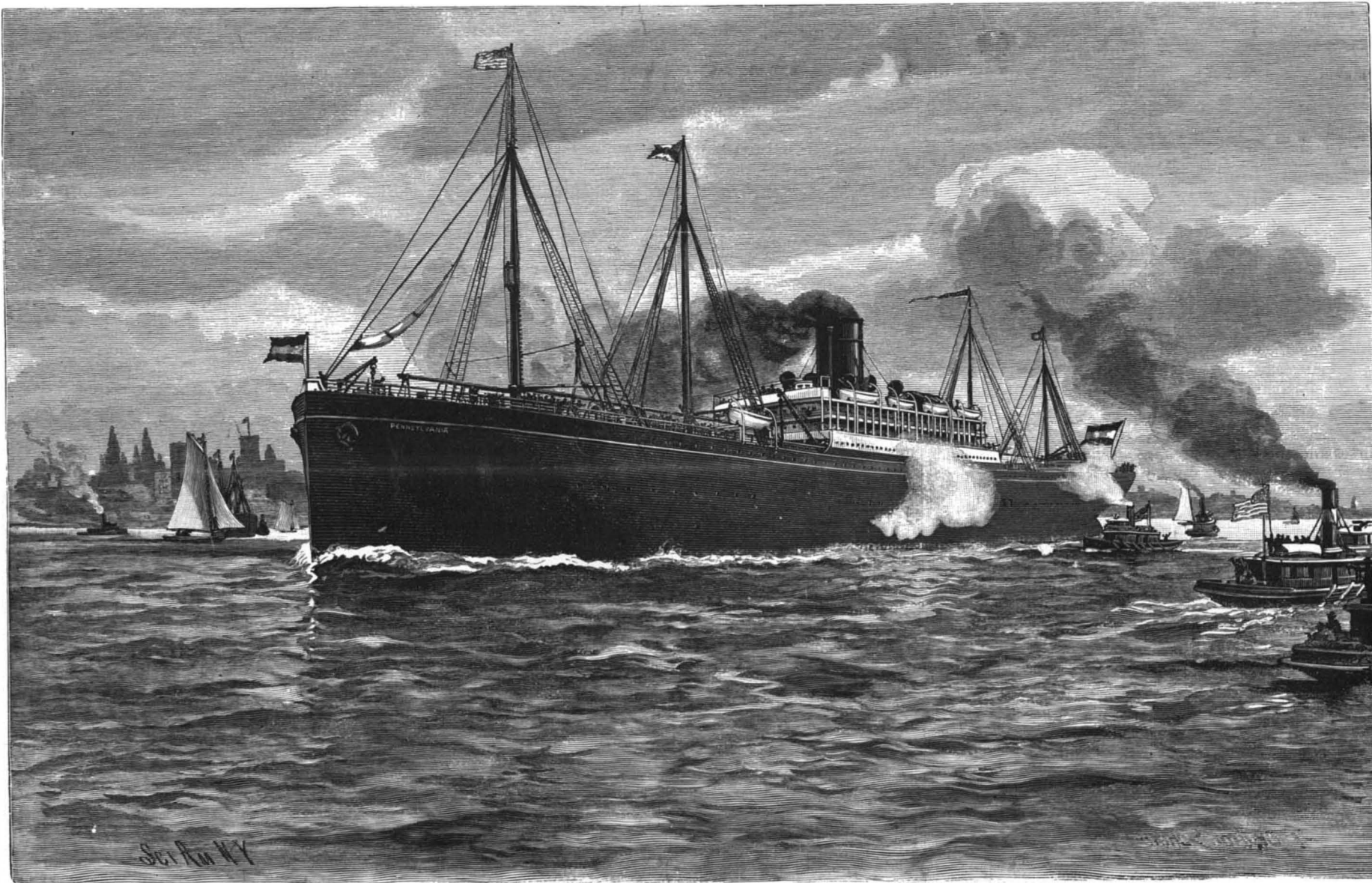

**THE PENNSYLVANIA, THE LARGEST FREIGHT STEAMER IN THE WORLD, ENTERING THE HUDSON RIVER ON HER MAIDEN TRIP TO NEW YORK, FEB. 9, 1897.**

Length, 560 feet; beam, 62 feet; depth, 42 feet; maximum draught, 30 feet; displacement, loaded, 23,400 tons; horse power, 5,500; speed, 14 $\frac{1}{2}$  knots.

draught is 30 feet. It has been frequently stated that the Pennsylvania rivals the famous Great Eastern in size, but a comparison of the dimensions of the two ships shows that the new cargo boat, big as she is, is yet a long way behind the leviathan of forty years ago.

The engraving which we publish of the Pennsylvania gives a correct impression of the imposing appearance of the ship as she made her way up the Hudson River on her first trip to this port. Large as her bulk appears above water, there is fully as much of it hidden from view below the water line. When she is loaded to her full capacity, her keel will be thirty feet below the surface of the water. She has eight decks in all, the lower deck, between deck, main deck, upper deck, awning deck—all five of these extending throughout the full length of the ship; and above the awning deck is a structure between two and three hundred feet long, in the center of the ship, which contains the saloon deck, the promenade deck, and the boat or bridge deck. The total height from keel to the boat deck is 72 feet, and when the boat is at her normal draught this last named deck will be 48 feet above the level of the water. The Pennsylvania is propelled by twin screw, quadruple expansion engines of 5,500 horse power. They are built on what is known as Schlick's patent, in which it is sought to secure a perfect balance by arranging the cranks at 100°, 100°, 100° and 60°, the odd spacing being adopted to compensate

dining saloon with seating capacity for 125 persons. On the after part of this deck is a handsome smoking room with accommodations for forty-five persons. There is a clear promenade space of 10 feet around the saloon deck. The promenade deck is exclusively devoted to the first class passengers, and as it will ordinarily be from 38 to 40 feet above the water, it will be a dry and comfortable spot in heavy weather. From its lofty height the passengers will never look in wonder up to the overhanging crests of the "mountainous seas," of which marine writers delight to tell, for the reason that they will be 10 or 15 feet higher than the tops of average Atlantic rollers. Careful observation has shown that the heaviest waves are rarely over 25 feet in height, whereas a person standing on the promenade deck of the Pennsylvania will be about 40 feet above the water when the ship is at her normal draught. When she entered the Hudson River her draught was light, and the boat deck, from which the navigation of the ship is carried on, must have been over 50 feet above the water line. It is this great height that deceives the eye as to her length, for no one unacquainted with her dimensions would suppose that she was but 40 feet shorter than the Campania.

On the boat deck, or bridge deck as it is sometimes called, is a long line of "telegraphs" for communication with the engine room and with the subordinate officers at each end of the ship. In handling a ship of

menced, or that defendant was advised as to its condition prior to the time of the accident, the defendant, as owner, could not be held liable. "Inasmuch as the place in question was no part of the sidewalk," says Justice Bradley, "and was not, apparently, open to use as such by the public, the owner or occupant was chargeable only for want of reasonable care to give safety to the use of this entrance into and from the building, and the burden was upon the plaintiff to prove the negligence of the defendant in that respect." — N. Y. Times.

**Advantage of Sleep.**

In reply to the question, Is it wise for a man to deny himself and get along with a few hours' sleep a day, to do more work? Tesla, the great electrician, is said to have replied: "That is a great mistake, I am convinced. A man has just so many hours to be awake, and the fewer of these he uses up each day, the more days they will last; that is, the longer he will live. I believe that a man might live two hundred years if he would sleep most of the time. That is why negroes often live to advanced old age, because they sleep so much. It is said that Gladstone sleeps seventeen hours every day; that is why his faculties are still unimpaired in spite of his great age. 'The proper way to economize life is to sleep every moment that is not necessary or desirable that you should be awake.'"



**A SNOW MELTING MACHINE.**

To a great city snow is rather a mixed delight; in the main streets it interferes with traffic of all kinds and soon becomes of the consistency of coarse sand. In New York a heavy snow storm is the signal for the marshaling of all the forces of the Department of Street Cleaning and the engaging of thousands of additional men and the hiring of three or four thousand carts. Broadway and Park Row are usually the first streets to be cleared; then follow the more important business streets, and finally, if there is not a thaw, the side streets; and for days a solid procession of carts, filled with snow, is seen in progress down the side streets toward the river, where it is dumped. A heavy storm may cost the city from \$75,000 to \$150,000.

It is only natural that there should have been many experiments directed toward the elimination of the bulky material by some less clumsy and expensive method. Of course the first way out of the difficulty which presents itself is to melt the snow. There have recently been tested in New York two snow melters, one coal burning and one naphtha burning. We illustrate the latter, the machine being made by the Snow and Ice Liquefying Company, of Paterson, N. J. The melter can be carried about by horses or it may propel itself, the rear wheel being connected with an engine by the means of a chain and sprocket wheels. During the recent severe storm it was found advisable to use both horses and the self-propelling mechanism, but ordinarily the self-propelling device should be sufficient, and it possesses great advantages, as the distance which the machine has to be moved is only fifteen or twenty feet at a time.

The melter consists of a four-wheeled vehicle carrying a naphtha tank over the front wheels, a boiler and machinery between the wheels and a long hopper or melting chamber extending beyond the rear wheels. Projecting above the melting chamber are a series of bars strongly braced; their relation to the melting chamber is shown in our small engraving. A curved hood protects the machinery from any snow which careless shovelers might throw toward it.

In brief, the operation is as follows: The machine is drawn to the spot where the work is to be commenced and a barrel of naphtha is pumped by hand into the large tank under the seat of the driver. A light wood fire is kindled under the boiler until about two pounds of steam are raised, then live steam is conducted through pipes into coils situated at the bottom of the oil tank. The heat from this steam vaporizes the naphtha in the tank and

causes a portion of it to pass into the separator situated on the top of the large oil tank, and from there it is conducted under the boiler, where it is consumed as fuel. When forty pounds of steam are raised the engine is set into operation, actuating a blower. Some of the air which the blower discharges is mixed with the naphtha vapor in the boiler firebox, so that the steam

producing a fine sight. Occasionally a sheet of blue flame rises upward along the gridiron, showing, apparently, that heat is applied to the interior of the mass of snow as well as underneath it. It is possible to discharge the water caused by the melting snow through a hose if desired. The bars of the gridiron are heavy and are strongly braced, so that the shovelfuls of snow

are at once broken up and slide down at the side. The flame of the naphtha and air comes into direct contact with the snow, melting it instantly. Everything is done to facilitate the rapid separation of the water and snow, as no heat units should be lost in heating water. The water drops to the ground and is carried away into the gutters and finally into the receiving basins of the sewers situated at street corners. Enormous masses of snow are melted in an incredibly short time. Occasionally a pile of snow that is soggy is pushed down into the melter by a man with a long iron rod used as a poker, in order to loosen it up

and make it melt more freely. Fourteen men are necessary to feed the insatiable monster. Besides the men shoveling snow into the machine, two or three men are employed to keep the gutters clear and scrape up the snow that falls from the shovels and the slush around the machine. As fast as the oil is consumed during the running process a new supply is being passed into the oil tank by a pump situated at the front of the machine under the tank. This pump draws the naphtha directly from the barrel. A water tank is also provided to supply the boiler.

When once started, the supply of steam and oil is maintained and the machine can be run for twenty-four hours or longer if desired, the shovelers being changed as they finish their day's work. As the water has a temperature ranging from 62° to 80° F., it flushes and cleanses the gutters and sewers. After a heavy snow-

fall there is always great trouble in the hiring of men and carts, but with the snow melting machines the difficulty would be lessened. The unfortunate feature of the use of carts in carrying away snow is that the horses cannot be worked more than eight or ten hours. With ice melting machines running day and night each may be reckoned as the equivalent of between thirty and forty carts, according to the length of hauls, and during the summer the machines are stored away and no expense is incurred for keeping horses.

The melting capacity of one of these machines is usually a cubic yard of snow per minute; the cost of a ten hours' run is as follows: 500 gallons naphtha at 5 cents, \$25.00; assistant engineer, \$3.50; engineer (or help-

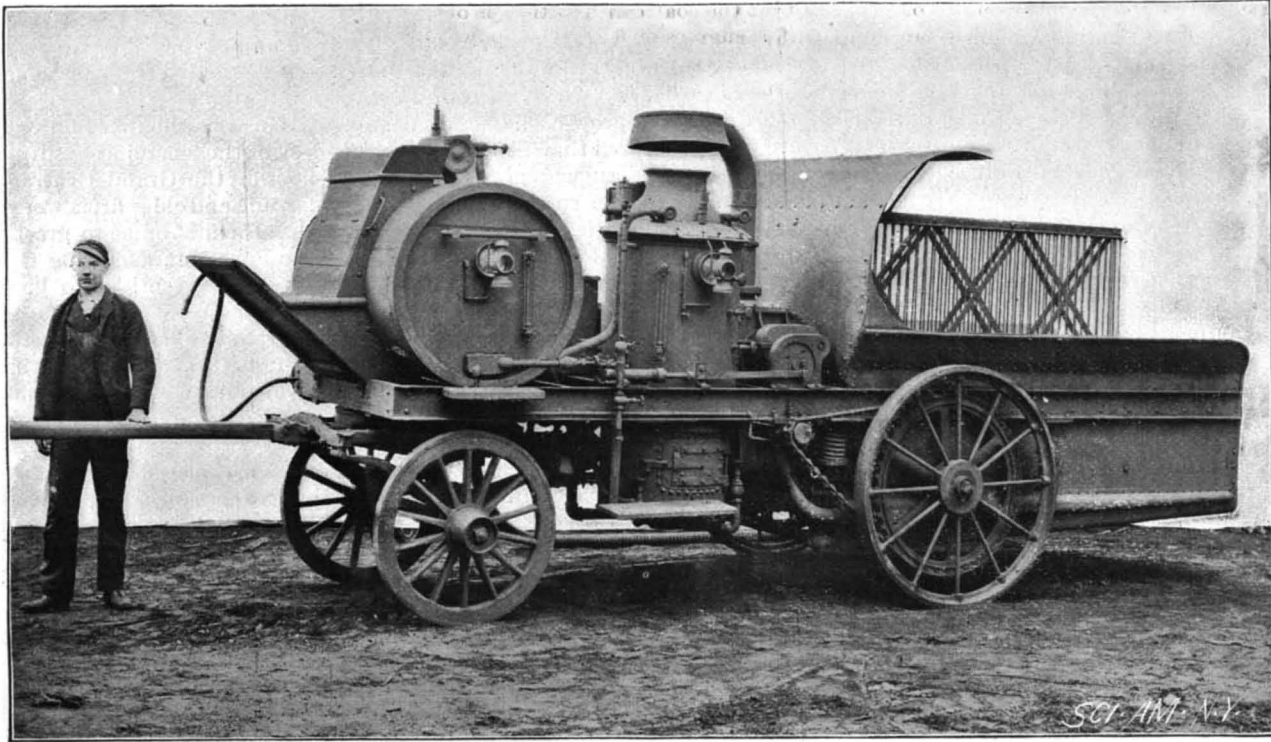

SNOW MELTING MACHINE NOW BEING USED IN THE STREETS OF NEW YORK.

pressure is readily increased to eighty pounds, and this pressure is maintained during the whole of the time when the machine is in operation.

When it is desired to begin the snow melting, the naphtha vapor from the separator and the air from the blower are turned into the melting chamber and are there mixed and ignited, burning in the twenty-four burners which are arranged like blowpipes at the bottom of the melting chamber. The burners are distributed throughout the length of the chamber at both sides. Air to insure combustion is admitted by holes in the side, and an additional supply is provided by means of forced draught. The relative position of the burners to the gridiron is shown in our small engraving. The burning of the naphtha vapor causes an intense heat which melts the snow at once. The flames blow outward at times through the openings in the gridiron,

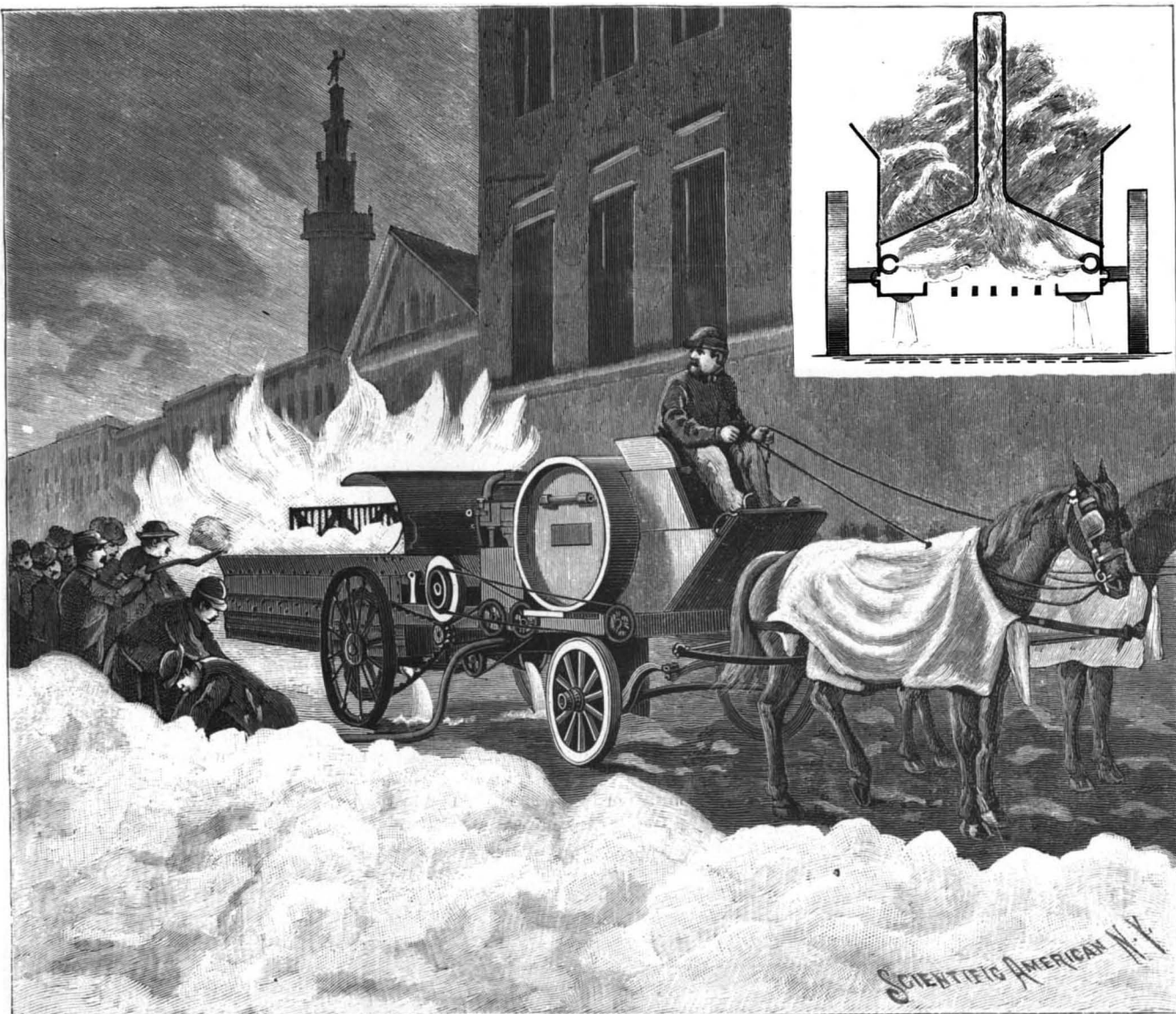

REMOVING SNOW FROM STREETS BY THE PROCESS OF MELTING.

er), \$2.00; two teams (drivers), \$10.00; fourteen shovelers at \$2.00, \$28.00; four shovelers (piling) at \$2.00, \$8.00; two men with brooms, \$4.00; sundries, oil, waste, etc., \$1.00; total, \$81.50.

#### The Beet Sugar Industry.

Nearly a century and a half has passed since Maggraf, a German scholar, announced in 1747 to the Berlin Academy of Sciences his discovery of a method of producing sugar from the beet, says the New York Sun. Half a century later, his pupil, Achard, explained to the same academy his improvements in that process. Then the industry began to grow steadily, and under the encouragement of Napoleon it made considerable progress in France. Indeed, during the wars of Napoleon, when the sugar-laden merchantmen of France and of Germany, coming from the West Indies, were so harassed as to be nearly driven from the seas, the times were favorable to beet sugar production in Europe. The decade following 1815 saw a great reaction, with the beet fields of France and Germany largely turned to other uses, and the beet sugar factories mostly closed. Then came a revival that lasted. The beet sugar industry was destined, however, to remain still a long time a target for the humorists, and one grave statesman compared it with the project of Swift's famous philosopher who sought to extract sunbeams from cucumbers. But it grew in spite of ridicule. Mr. E. Sowers, who, in the North American Review, urges a wider field for it in America, says that the production of beet sugar in France for the year ending July 31, 1830, was 4,380 tons; in 1840 it was 22,784, in 1850 it was 62,165, in 1860 it was 126,479, in 1870 it was 282,136, in 1890 it had reached 750,000 tons. Again, in 1830, the consumption per person in France was two pounds; in 1865, fourteen pounds; in 1890, twenty-six pounds.

A like growth in Germany is noted during a period of about fifty years.

	Sugar, tons.	Molasses, tons.
For 1840.....	13,445	8,955
For 1850.....	52,586	19,877
For 1860.....	126,526	35,224
For 1865.....	180,000	50,544
For 1871-72.....	186,442	63,892
For 1881-82.....	599,722	150,813
For 1889-90.....	1,213,689	240,797

Indeed, beet sugar has for Germany become an important article of export. In the year 1877 the amount sent out of the country was 57,753 tons. Ten years later it had increased more than tenfold, to 643,340 tons, while in 1890 it had reached 718,985 tons. In 1890 our country paid Germany \$16,000,000 for about 200,000 tons of beet sugar, and Mr. Sowers observes that this was "nearly three times more than it paid for any other article" imported from that land.

How does this industry stand in the United States? Mr. Sowers tells us that in 1891 the production here was 12,004,838 pounds; in 1892 it was 27,003,322 pounds; in 1893 it was 44,836,527 pounds. He has no figures for 1894 and 1895, but if the increase has continued at anything like the rate just noted, the product by this time must be very large.

Parts of Kansas, Nebraska, the Dakotas, California, and Utah have already been devoted to sugar beet culture, with most promising results. The rich soils and warm and even climate of California and Utah, especially when aided by irrigation, are suited to an abundant and excellent yield. In 1892 California alone produced about 20,000,000 pounds of beet sugar. Nebraska and the Dakotas add to a natural richness of soil sufficient rainfall in the season of rapid growth. The farmers of Nebraska find that the temperature for June, July, August, and September is so high and even as to bring the beet to full maturity early in October. That State produced 5,835,900 pounds of beet sugar in 1893, or more than double the amount of two years before, and it also has one of the most successful beet sugar factories. Improvements in making the sugar go on, and a better knowledge is steadily gained of the conditions which tend to increase the yield.

A summary of facts given by Mr. Sowers in regard to this industry will be of interest:

"The yield of sugar beets varies from twelve to forty tons per acre. The best land, with good cultivation and a favorable season, will yield from twenty to thirty-five tons per acre, but the crop would be hardly profitable at a yield of less than twelve tons per acre. In California the greatest production from a single acre of land was a little more than forty tons of beets; but this is an unusual yield. The estimated cost of production per acre is about fifty dollars. In the present condition of the methods of manufacture, from eight to twelve pounds of beets are required in the making of one pound of sugar; the quantity varies according to the greater or lesser richness of the beets in sugar. The price changes with the conditions of the market. About four years ago beet sugar from Germany was landed on the wharves of New York at a cost of three dollars and eighty-one cents a hundred pounds. It rarely costs now above five cents a pound."

During the last sixty years such improvements have been made in the process of manufacture that, instead of converting from 4 to 5 per cent of the beet into

sugar, 12 to 16 per cent are converted now, and the cost of production per pound, which was once from 8 to 12 cents, is now only from 2 to 4. The average cost here in 1893 was 3 cents, and 24,000 acres were used for growing sugar beets, which brought to the farmer an average price of \$4.50 a ton. An acre produced 3,661 to 4,620 pounds of sugar. In that year there were seven factories in the country, with a capital of about \$2,000,000.

If the figures of Mr. Sowers are correct, the annual consumption of sugar per capita in Germany is 18 pounds; in France and Switzerland, 26; in the United States, 44, and in England, 60. These are extraordinary differences, and England appears as having the sweet tooth. We are further assured that France, Germany, and Austria produce beet sugar enough for home consumption, and import little sugar, while Germany and France export large quantities. In 1892 Germany sold to English purchasers alone nearly 600,000 tons of beet sugar, the product of their factories and fields.

As to our country, it is declared that we "spent annually about \$135,000,000 for sugar, of which more than eight-tenths goes to foreign countries. We consume one-fourth of the exported sugar product of the world. Fifty years ago, 94 per cent of the annual sugar product of Cuba found a market in Europe; now that proportion of its production is sold in the United States." This last extraordinary statement suggests the vast commercial interest which we have in that island, and its growth in fifty years.

#### CONTRACTION OF THE FACE IN JUMPING.

In a jump, says Longet, the entire body detaches itself from the ground and floats in the air after the manner of a projectile. The photograph that we reproduce, and which was taken by a photographer of Saint-Die, shows the justness of this comparison per-



CONTRACTION OF THE FACE IN A JUMP.

fectly. The stress of impulsion causes a contraction of the entire body. The trunk and limbs at the moment of rising form a rigid and undulated rod.

The photograph in question gives the image of a very high jump at the moment that the impulsion is given. It reproduces the body in full stress and in entire contraction. The violence of the stress may be seen from the aspect of the young man's countenance. The nose, eyebrows, eyelids, forehead and neck are violently contracted. The effect is so much the more marked in that the energy of the stress has congested the face.

One might say, from an inspection of the figure, that the jumper was suddenly experiencing a severe pain, and that he was about to burst into tears.—La Nature.

TH. GUILLOZ (Medical Week, June 5, 1896) says that he first successfully employed photography of the retina for clinical purposes in the year 1893. His procedure is based on the following principle: When the pupil is dilated, the fundus of the eye may be illuminated, so as to permit of examination of the retina with a lens, without the necessity of any ophthalmoscopic mirror. The observation is thus made on the reversed image, and it is this image which is fixed by means of a photographic objective. Moreover, as the time of exposure, however short, is an inconvenience, he has constructed a special apparatus for instantaneous photography of the retina. The photographs obtained in this manner show the ophthalmological image reversed, as it appears on examination, with the reflection from the optic disk and cornea; but since then the author, by a new method of illumination has succeeded in getting rid of this reflection.

#### ECHOES OF THE ANNUAL BICYCLE EXHIBITION.

Although there have been no radical changes in the 1897 model, it is undeniable that this year's bicycle is a much handsomer machine than its predecessor. This is due to the great care and the good taste with which every detail has been designed and finished off. Larger tubing, particularly in the stays and rear forks, the shapely arched fork crown, the compact adjustments of handle bar and seat post, the increased diameter of crank hanger and hubs, have given to the 1897 bicycle an appearance of greater strength and durability without detracting from the general grace and beauty of its proportions.

This was the first impression on taking a rapid survey of the magnificent display shown on the second floor of the Grand Central Palace, where most of the leading and older firms were represented. It was fitting that the first name to greet the eye should be that of the Pope Manufacturing Company, whose senior member is justly entitled to be called the father of the bicycle industry in this country. In speaking of such a progressive firm no higher compliment can be paid to its 1896 wheel than to say that this year's pattern varies from it in few essential particulars, the chief change being in the introduction of direct tangent spokes on the hubs, box fork crowns with a nameplate attached (placed there as a protection against the bicycle thief), and improvements in the divided crank shaft, a device which this firm was the first to introduce.

E. C. Stearns & Company had a full display of the famous "Yellow Fellow" wheels, conspicuous among which was the many-triangled truss of the famous septuplet, which had already done duty at the great London and Chicago shows. Another curiosity was the wheel on which Anderson recently reeled off a mile in 1 minute and 3 seconds behind the friendly shelter of a shield attached to a moving train. The gear was one hundred and twenty, and if, as the Stearns Company asserts, the timing was accurate, the feat proves that atmospheric resistance is by long odds the most serious that the bicyclist has to contend with.

The adjoining exhibit of the Remington Arms Company showed the beauty of finish and the close attention to detail which the long experience of the firm in the manufacture of high grade material would lead one to expect. Every part of the machine is made at the works, even to the chain. The bayonet cranks of triangular cross section were suggested, as the name implies, by the bayonets which are made by the firm, and they are certainly adapted to resist the strains to which the crank is subject.

The Lovell Arms Company showed several improvements, including a divided crank axle which is locked by a screw passing through the crank hub. The crank axle is made by rolling up a strip of Swedish plate steel into a hollow tube and welding the longitudinal joint. The bearings are oiled through the axle. In place of a cup they use a two-point bearing cone with the object of diminishing friction.

The Sterling Cycle Works are justly proud of the fact that many of this year's improvements in other wheels had been anticipated in their earlier machines. The Sterling oval fork has been changed very little, if at all, from the original design. They still favor tubing and, relatively to other 1897 wheels, small diameter bearings. The wheel is the lightest appearing machine in the show, and reveals careful work and high finish. It is claimed that the company was the first to use the direct tangent spokes and corrugated hubs. Other new features are the use of cup bearings screwed into the crank hanger, the Morse roller bearing chain and the use of large sprockets.

The Indiana Bicycle Company has turned out an extremely handsome wheel in the 1897 Waverley. The most novel feature is the design of cranks and crank axle. The latter is hollow, and the crank, which is squared at its large end, is let into a slot cut across the end of the axle and held in place by a bolt which passes through the axle. This enables the bearings to be removed from the hanger without altering their adjustment.

The Eagle Manufacturing Company has made a great advance over last year's wheel in the matter of details. It still offers the justly celebrated aluminum rims, which for many years have been the distinguishing feature of the Eagle wheels, but in deference to the popular taste the manufacturers furnish their high grade wheel with wood rims, substituting the aluminum rims if preferred. The changes in the new wheel include a double drop-forged crown, a narrower tread (4½ inches), the cantilever front sprocket (a handsome design which has attracted much attention), D forks for the rear wheel, ball retainers for all bearings and a large diameter tapered handle bar, the size at the head being 1½ inches. The ladies' wheel, with its elegant and mechanically designed tritubular frame and its aluminum dress shield and rims, is one of the handsomest machines in the exhibition.

The Keating Wheel Company retain the characteristic "curve" in the main tube, put there with the object of resisting more effectually the twisting strains in the crank hanger. The corrugated hubs are cut from the



solid bar, the recesses being milled out with a special tool, leaving the studs for attaching the tangent spokes as an integral part of the hub. They are a curiosity of manufacture, showing the infinite work that is expended in the production of a first-class wheel. Perhaps the strongest recommendation of this wheel is the double roller chain, in which each pin is encircled with an accurately fitted steel roller. In taking the sprocket the chain rolls, instead of sliding onto the teeth—an obvious advantage.

The Tribune bicycle is shown with the cycloidal sprocket, which is designed to secure a perfectly tangential pull, the center line of the chain being normal to the face of the teeth as they come into engagement. The Black Manufacturing Company believes that the best method of "dustproofing" bearings is to make them with flush exterior faces, where the dust and dirt will find no projections to lodge in. A novelty in crank fastening is shown in cutting fine V shaped longitudinal corrugations on the axle and crank of the wheel, which take up all the rotary thrust of the crank.

Adjoining the last exhibit was the really superb display of "White Fliers" by the Barnes Cycle Company. These were the first machines to use the internal wedge adjustment on seat post and handle bar. This wheel has both cranks, the axle, and the sprocket flange in one solid forging.

Close at hand were two other wheels of special finish and great beauty, the Fenton and the Fowler. In the former the Fenton Metallic Manufacturing Company has adhered to large tubing, using for this year's wheel 1 1/4 inch in the frame and 1 1/2 inch in the head, and the machine is rendered very attractive by its beautiful translucent finish. The Fowler Cycle Company retains in this year's wheel the characteristic truss frame, and has adopted a neat arched fork crown, a two-piece crank axle and a special design of seat post clamp.

Of the Eclipse bicycle shown on the same floor it is sufficient to say that it is even more shapely than last year, with its D tubing, dropped crank hanger and arched double crown. The Monarch Cycle Manufacturing Company are also thoroughly up to date in its new wheel. It is built with 1 1/4 inch tubing in the frame, 7/8 inch D tubing in the rear forks, laminated wood rims with nickel plated eyelets in the spoke holes, and compact seat and handle bar clamping devices.

Conspicuous among the veteran makers was the Overman Wheel Company, which exhibited every separate detail of a modern Victor, as well as several finished machines of great beauty. This is one of the firms that has not followed the fashion of barrel hubs. The rear

the unskilled mechanical fingers of the majority of riders.

The curious exhibit of 126 diminutive Trump cyclometers by the Waterbury Watch Company was intended to show the correctness of the reading. The cyclometers were arranged in rows and rotated by an endless chain of "strikers," which was run by an electric motor. But undoubtedly the most unique exhibit in the show was a skeleton built up entirely of drop forgings made by Billings & Spencer. Never was such an anatomy seen before. Bicycle cranks jointed into nut crackers and sewing machine shuttles formed the toes to feet, above which were skeleton legs composed of engine cranks and piston rods.

The Johnston two-speed gear shown in the engraving is placed on the rear axle. When the high gear is in use, the sprocket is concentric with the wheel hub and

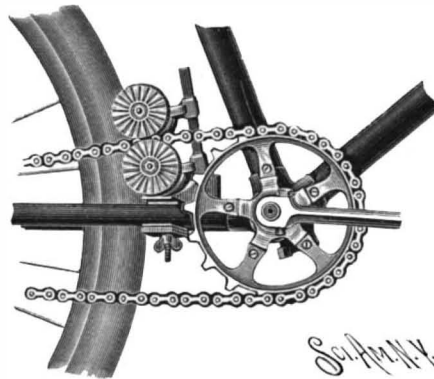

THE NEWPORT BICYCLE CHAIN CLEANER.

the speed of wheel hub and sprocket is the same. The change to low gear is effected by lifting a small rod attached to the rear stays, which at once unlocks the sprocket from the wheel hub and by means of a cam wedge, shown in the drawing immediately above the axle, lifts the sprocket hub with its interior sleeve and bearings into engagement with the gear on the main hub of the wheel. In addition to the high and low gear positions, there is a third position in which the sprocket rotates quite independently of the wheel—an arrangement which enables the rider to stop the pedals and keep his feet upon them when coasting down a hill.

An invention which will be welcomed by those riders who object to a brake because it spoils the general symmetry of the wheel is the Spencer invisible coil brake, of which we give an illustration. The whole of the mechanism is placed within the frame of the bicycle and is, therefore, completely out of sight. The

assisted by the rotation of the axle. There seems to be unlimited power in this brake, and as a mechanical ingenuity it is highly creditable.

We also give illustrations of the Wizard Bicycle Chain and the Brown Roller Sprocket, both of which are designed to reduce the friction of the driving mechanism. The Whitney Manufacturing Company, the makers of the chain, claims that links of this triangular form are lighter than ordinary 1/4 inch chains and about 300 pounds stronger. In the common form of chain the blocks are weaker than the side links, as the latter are made of sheet steel, which is of a higher grade material than the drawn steel of the center blocks. This chain has both center and side links of high grade sheet steel. The sprocket is made with a double rim, the projections on the chain engaging rollers carried on pins which are riveted in between the rims.

The Brown roller sprocket is also made with a double rim, between which are carried a series of disk wheels, which take the place of the teeth in an ordinary sprocket. Both of these devices are designed to avoid the friction which results from the "climbing" of the chain on the teeth of the common form of sprocket.

The Newport bicycle chain cleaner forms the subject of another illustration. It consists of two small rotary brushes, which are operated by friction rollers bearing on the tire of the rear wheel. The device is clamped to the rear forks back of the crank hanger, as shown, and the action of the brushes is so rapid that the chain is thoroughly cleaned with a few turns of the cranks.

Our notice of the general advance which is seen in the bicycle of 1897 may well close with a reference to a remarkable wheel shown at the Spalding stand as an exhibition of the endurance of their 1896 model. This was a bicycle which had been ridden for 1,500 miles over the rough roads of the Rocky Mountains by one of a company of United States soldiers, who made the trip to test the value of the bicycle for military purposes. The weight of machine and equipment was over eighty pounds, and, although the wheel showed many outward signs of its rough treatment, every essential part of it was in good working order.

Transmission of Earthquake Motion.

In a recent lecture delivered by Professor John Milne, formerly of the Imperial University, Tokio, to the members of the Edinburgh Philosophical Institution, on "Earthquakes and Volcanic Disturbances," the author stated that the chief feature of the lecture was the announcement of the fact that an earthquake occurring in any portion of the earth could be recorded in any other part by means of suitable instruments. He showed diagrams of earthquakes recorded in England which had originated in Japan. The motion came from Japan to England in sixteen minutes, and therefore in all probability traveled through the



1. Detail view of coil. 2. Connections between coil and handle bar.  
THE SPENCER INVISIBLE COIL BRAKE.

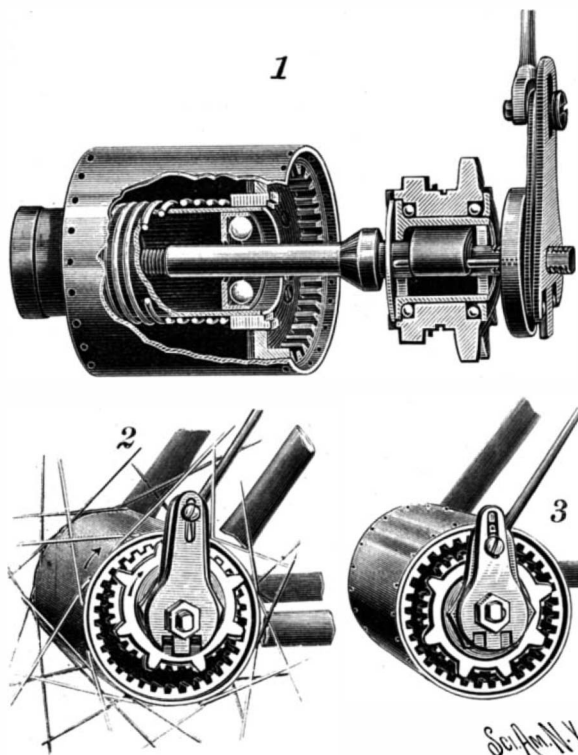

1. Sectional view of gear. 2. Gear in low speed position. 3. Gear in high speed position.  
THE JOHNSTON TWO SPEED GEAR.

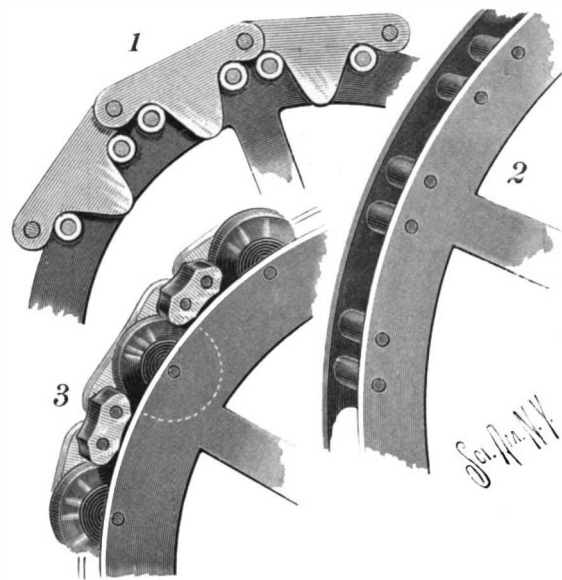

1 and 2. Wizard bicycle chain and sprocket. 3. Brown roller sprocket.  
THE WIZARD CHAIN AND BROWN SPROCKET.

NOVELTIES AT THE NEW YORK BICYCLE SHOW.

hub, turned from a solid piece of steel and oil hardened, is a piece of work which will commend itself to the mechanical eye. The new wheel shows the characteristic large diameter hollow crank shaft, improved, with detachable cranks. The arched fork crown is a solid steel forging and there is less curve in the forks than in the earlier models.

The Western Wheel Works have greatly improved the appearance of the Crescent wheel, which is one of the most shapely of the 1897 models. A noticeable feature is the use of the D tubing in both rear forks and stays, and the peculiar construction of the plate steel sprocket. The outer edge of the latter is bent over to give a double thickness, out of which the teeth are cut. The worm adjustment for the chain will be appreciated by

brake proper consists of a spiral coil of flat spring steel, which is tapered in breadth and thickness and wrapped around the crank axle in the direction in which it rotates. To the small outer end of the coil are attached a few links of chain, to which is fastened a length of steel rope which passes up through the lower tube to the head. Here connection is made with a vertical rod at whose upper end are a short length of chain and another piece of steel rope, which latter passes through the handle bar to the right hand grip. Here it is attached to a pin which travels in the direction of the axis of the grip by the action of a worm cut in a metal cylinder on the inside of the grip. By turning the grip to the right, the rope is drawn taut and tightens the coil upon the axle, the action being

earth rather than around its surface. This high velocity with which motion was propagated indicated that the earth had a higher rigidity than had hitherto been supposed; in fact, the globe transmitted motion more quickly than a ball of glass and steel. In order to learn more about the nature of the interior of the earth, he suggested that there should be placed on its surface at intervals of from 1,000 to 2,000 miles instruments for picking up the unfelt earthquake motion. The cost of these installations would be about \$250 each, and twenty of them would be sufficient. With such an equipment we might learn more about the nature of the earth on which we live in a period of three years than we should by a hundred years of speculation.

## RECENTLY PATENTED INVENTIONS.

## Engineering.

**ELEVATOR DRIVE WHEEL.**—George S. Fouts, San Jose, Cal. To effectively drive a rope, cable, or other band for elevators and other carriers, this invention provides a pulley having in its rim a groove whose base is continuous, forming a smooth, solid seat, while at intervals the side walls have openings through which operate grip sections, connected with one or more cam rings upon the shaft and hub. A cam groove of the cam ring is so formed that it will operate the gripping sections to grip the rope on a portion of the circumference of the pulley and free it at other portions, permitting the rope to move freely into and out of contact with the pulley and yet tightly clamping it to the pulley for driving purposes.

## Railway Appliances.

**CAR TRANSFER BOAT.**—Walter G. Berg, New York City. This boat has a vertically movable platform arranged to permit of running a car upon it and raising or lowering it and a car, according to the difference in height between the pier or landing and the boat. The boat is wide and long, to accommodate several lines of track, and has at one end a turntable, with which supports are held to turn. A platform suspended from the supports being adapted for vertical movement, and there being an apron hinged to the platform at its periphery. A hoisting device is connected to the platform, and any suitable power may be employed for turning the turntable, and for raising and lowering the platform or swinging the apron.

**RAILROAD GATE.**—John J. Flippin, Neapolis, Va. Devices operated by compressed air are arranged, according to this invention, to lower a gate at a road crossing as a train approaches from either direction, the moving train also actuating the devices to raise the gate after the train has passed. A main pipe along the track near the crossing is kept charged with compressed air from receivers or by other suitable means, and the apparatus includes a gate wheel having cylinders and pistons, a valve wheel pneumatically operated in one direction and oppositely actuated by a spring, pipes connecting the valve wheel with the air mains, and tripping devices being connected with the controlling valves.

**AUTOMATIC SWITCH.**—Carl Reger and Eugene Duerr, Buffalo, N. Y. To enable a motorman on a street railroad to open a switch and run his car on a branch track, the switch again closing automatically when the car has fully passed upon the side track, according to this invention, a pivoted switch point is connected with a lever operating two switch levers, one in the main track and the other in the side track. The switch is opened by depressing a staff sliding in a casing on the platform of the car, and is automatically closed again by the swinging of a lever caused by the engagement of an arm by the flange of one of the rear car wheels.

## Electrical.

**LIGHTING VEHICLES.**—Jules A. Ageon, Paris, France. For lighting wheeled vehicles this inventor provides an electric generator operated by the rotation of the wheels, an accumulator connected therewith, rotatable circuit breakers in the connection, driving disks movable from one circuit breaker to another, and a lamp in circuit with the accumulator. The apparatus is designed to afford light not only during the forward travel of the vehicle, but also while it is stationary or traveling backward, and its dimensions and weight are but moderate. A continuous current magneto electric machine is employed, having its brushes so disposed as to permit of rotation in either direction, and the accumulator supplies the desired current when the machine is out of action.

**ELECTRIC SWITCH.**—Maximilian Schalscha, Hoboken, N. J. This is a switch for automatically regulating the current through a motor to gradually increase or decrease the speed, the device to be carried by a car and comprising a series of contact plates through which the circuit may be closed by a switch arm, the arm being mounted on a rotary shaft, while a rotary shaft has gear connection with the arm carrying shaft, and arms are extended radially from the last named shaft. Pins are located on the track in the path of the arms to engage and move them, and there is gearing between the shaft and the contact arm to drive the latter from the former.

**ELECTRIC LOCOMOTIVE AND RAILWAY.**—This patent is for a further invention of the same inventor, according to which the current is automatically regulated, dispensing with the services of an attendant while the cars move from one point to another and return. The invention provides for rapidly and economically conveying coal, etc., from a vessel or car, the car being started by turning on an initial current and automatically attaining full speed, but the current being gradually and finally cut out and reversed. In the case of a dumping car the invention also provides simple and automatic means for releasing the dumping mechanism, whereby the contents may be discharged into a pocket or receptacle.

## Mechanical.

**DIE STOCK.**—Gustav Wagner, Reutlingen, Germany. In screw-cutting dies this inventor has devised a die with several sets of differently arranged screw-cutting jaws, so that threads of different pitches may be cut with the same die without removing the jaws or cutting tools. The cutting edges may be readily adjusted to any desired diameter and securely held after adjustment to prevent displacement of tools during the cutting operation, avoiding any inexactness from a soiled condition of the die and the loss of individual tools, while simplifying the manipulation of the die.

**PLUMBER'S CLAMP.**—James H. Griffin, New York City. This is a device more especially designed for temporarily holding lead pipes in place while wiping a joint, and comprises a U-shaped clamping arm having at one end a seat for the pipe and at the opposite end a nut in which screws a rod having on its lower end a

clamping plate adapted to engage the pipe on the side opposite the seat. The latter has an extended socket in which is a supporting pin in a suitable base, and in direct line with the screw rod and seat.

**STAVE PLANING MACHINE.**—Carl S. Algren, New York City. For dressing the outer and inner surfaces of staves intended for use in building tanks, vats, or similar work, this machine is made with an ordinary cutter head to dress the inner sides of the staves, and two movable cutter heads to dress their outer surfaces on a bevel, that the hoop or band placed about the tank or vat may have a better bearing surface. The latter cutter heads are made movable on the shaft in order to accommodate them to staves of different widths and to cause the bevel to be started from the outer edges of the staves. The adjustment of the cutter heads is automatic, being accomplished by the action of the edges of the staves against guide levers.

## Agricultural.

**COTTON CHOPPER.**—John R. Miller, Bend, Texas. The choppers are, in this machine, adjustable to regulate the distance between the hills, and cultivators are arranged to follow the choppers in such manner that the spaces between the rows of hills will be cultivated as the hills are formed. The ground or supporting wheels are adjustably placed on their axles corresponding to the adjustment of the choppers, to insure a uniform distance between the rows of hills as the machine is drawn up and down the field, and, by means of levers within convenient reach of the driver, the plows and choppers may be made to enter the ground as far as desired or be entirely removed from the ground.

## Miscellaneous.

**MAGAZINE FIREARMS.**—Gardner P. Hastings, Springfield, Mo. In this arm is a mechanism by which the empty shell is extracted by the loaded shell to be next placed in the cartridge chamber, the extractor being effectively and surely operated from the breech block. A better bearing of the slide action upon the hammer is also obtained than heretofore for cocking the hammer, and the firing pin is made in two sections, one in the breech block, and adapted to strike the shell, while the other section is adapted to receive the impact of the hammer, being placed in a recoil locking block. The latter occupies such position during the extracting of the shell and the loading of the cartridge chamber as to carry the breech section of the firing pin entirely out of the path of the hammer, such section being brought into concerted action with the other section only when the cartridge is fully within its chamber and all parts are in position for firing. The magazine may be readily secured in or detached from the gun.

**TYPEWRITER ATTACHMENT.**—Walter P. Butler, Minneapolis, Minn. This invention is designed to enable operators on typewriters to more easily execute tabulations of items and figures and to dispose the subject matter more uniformly and neatly. In effecting this end, the inventor provides a digit scale and a pointer which he may fix respectively to the frame and carriage, or vice versa, so that there will be relative movement as the carriage moves on its track. Thus, by establishing a known relation between the scale and platen, it is easy to bring the platen into any desired position with reference to the type, and consequently to arrange items and figures in any manner on the paper. The parts are readily interchangeable and are applicable to any style of typewriter.

**WIRE FENCE TOOL.**—Norman D. Wintersteen, Sac City, Iowa. A readily portable tool has been devised by this inventor to facilitate the erection and repair of wire fences, for placing the wires along a line of posts, stretching and splicing them while they are being secured in place, and the drawing of staples from posts and straightening them for reuse. The tool comprises two lapped and pivoted handle arms, each having a jaw member inwardly bent, one member with a notch and the other with a projecting nose to enter the notch, while the jaws are also longitudinally slotted, with a ratchet toothed stretcher bar longitudinally movable in the slots, dogs engaging the stretcher bar, on one end of which is a clamping bar, and there being means for locking the handle arms together.

**PIPE WELL AND MEANS FOR DRIVING IT.**—Nelson W. Davis, Port Jefferson, N. Y. Instead of first driving the well pipe and then pumping out and inserting a strainer section, as heretofore, this invention provides a pipe which may be driven by pressure at its lower end and on top of the strainer, or at the lower end of the strainer, where there is a steel shoe section adapted for engagement with a rod connected with the driving head, on the upper end of a screen protector tube. Another form of driving head and strainer point are also provided, with which the strainer can be used as an open or closed end drive pipe, in both forms the driving blow being practically delivered at the lower end of the well tube, allowing a harder blow to be given than in the usual method of driving.

**PUMP.**—John D. Wilcox, Gilman, Ill. This is a pump particularly adapted for pumping sand and water from oil or similar well tubes during the operation of boring. The pump handle is fulcrumed on a link pivoted to lugs, making a shifting fulcrum to allow its end to move in a direct vertical line with the pump rod, and on the plunger is a valve made in two sections and designed to prevent clogging with mud or sand. On the upper end of the body portion of the pump is a water and dirt receiver having an outlet spout, and there is a swivel connection between the pump body and receiver.

**MEASURING INSTRUMENT.**—Hercules Scott, Princeton, West Va. This is an instrument more especially designed to facilitate measuring the area of plots of land, and also adapted to measure the distance between objects, the heights of objects, etc. It comprises a table or base at opposite sides of which are stationary sights, and a sighting arm pivoted at one end of the sight lines, the table having two graduations on which indicates the pivoted arm. One of the graduations indicates the distance of an object sighted on the pivoted arm and on the sight line at the opposite side of the table, the other graduation indicating the distance between two objects when one is sighted on the pivoted arm and the other on the adjacent sight line.

**HEATING AND COOLING COIL.**—Julius E. Koester, New York City. This is a coil which may be readily cleaned and subjected to a high or low temperature to heat or cool a liquid made to flow through it. It is made of two or more grooved sections separated by a division plate having an opening for connecting the adjacent ends of the grooves with each other and causing the liquid to first flow through the groove in one section and then through the groove in the other section.

**PICTURE EXHIBITOR.**—George W. Brown, Colorado Springs, Col. This patent is for an improvement on a former patented invention of the same inventor, and provides a simple construction for use in connection with a phonograph or like instrument, and actuated with the phonograph by the same power. It comprises a closed casing in which are rollers, one of them connected with an operating mechanism, an illuminating device being arranged in the casing, a strip carrying pictures arranged to move over the rollers and an eyepiece in position to render visible the pictures on the strip.

**VIOLIN CHIN REST.**—Myron H. Coloney, Denver, Col. This is a device which may be readily placed in position on or removed from the instrument, and comprises a tubular shank made in two parts, one slidable on the other, a head on one of the parts carrying the rest proper, and there being a foot on the other part. A post fixed to one of the parts has a projection engaging a vertical slot in the other part, and a spring on the post draws the head and foot toward each other to clamp the device in place on the instrument.

**SIGN LETTER.**—Raleigh M. Pearson and William Letzig, Little Rock, Ark. This is a transparent letter backed with gold, silver or colors, the letter having a backing of tin or lead foil, whereby the letters will be exceedingly transparent and the color thoroughly protected. The letter, character or symbol is so shaped that it may be attached to the inside or outside of a pane of glass with equal ease, and the letter may be applied to the plane surface of any material by a cement which does not appear over the entire surface of the letter but is confined to its margin.

**SIGN WRITER'S APPARATUS.**—Herman C. Carver, Red Oak, Iowa. This improvement comprises a body portion provided with liquid feeding devices, a guide to engage the surface on which the sign is to be painted, and a supplemental arm to engage the hand of the operator and indicate the degree of pressure applied to the guide. The body portion has a flanged mouthpiece which may be closed by a block through which passes a point serving to form the fine lines, while the block may be moved inwardly to permit the flange of the mouthpiece to form shaded lines, the apparatus being capable of very readily and beautifully forming the various shade lines and scrolls desirable.

**STAMP RACK.**—David S. Haines, Sandy Hill, N. Y. This is a rack for holding postage stamps to be offered for sale, and comprises a frame in which are two uprights having vertical slots in which are journaled two pairs of rollers, there being a turning knob on one trunnion of each roller, springs bearing on the trunnions of the upper rollers and an apron oppositely wound over the rollers. Upon the apron are numerals corresponding to the number of stamps on a sheet, and the stamps are so held that the attendant can always readily determine the number sold, while the inconvenience and liability to loss from having single stamps lying around is obviated.

**SHOW STAND.**—Henry Klein, New Lexington, O. This is a stand more especially designed for holding window shades in assorted styles, so that it will not be necessary to handle all to get a desired style, and protecting their edges or ends, while the shades are readily removable as desired. The stand is circular, revolving on a central shaft, and is divided into compartments by radial partitions, the compartments being closed by top and bottom plates and doors, having an open middle space through which the shades may be seen. The doors, at the bottom, are opened to insert or remove shades.

**NOTE.**—Copies of any of the above patents will be furnished by Munn & Co. for 10 cents each. Please send name of the patentee, title of invention, and date of this paper.

## NEW BOOKS AND PUBLICATIONS.

**BICYCLES AND TRICYCLES.** An elementary treatise on their design and construction. By Archibald Sharp, B.Sc. With numerous illustrations. London and New York: Longmans, Green & Company. Pp. 536. Price \$4.

The rapidity with which cycling has attained such great and general popularity, as well on the other side of the Atlantic as in this country, gives especial interest to the appearance of a book forming, as this one does, a valuable addition to bicycle literature, and which treats of the design and construction of machines from a scientific standpoint. Part I treats of mechanics and the strength of materials as applied to bicycle construction; Part II of the development of the machine—stability, steering, gears in general, etc.; and Part III of the frame, wheels, bearings, varieties of gear, tires, pedals, cranks, springs, and saddles, etc. The book has many valuable tables and diagrams, and is an up to date treatise for the intelligent and critical bicycle rider.

**FIRST AID IN ACCIDENTS.** What to do in emergencies until the doctor arrives. Manual of "First Aid to the Injured," for the Fire Department, to be used as Hand Book by the Members of the Red Cross Society American Firemen. New York: Fred J. Miller. 1895. Pp. iv, 52.

There is something about the ground covered by this work which would suggest an English origin, so that it is a real comfort to find that so practical a subject, and so well treated, is here executed specifically for the American market. It applies particularly to firemen and is designed to be used by all members of the force. It simply tells what is to be done in case of accidents until the doctor arrives, does not attempt to substitute the help of the uninitiated for that of a physician, but simply to hold one secure from danger as far as possible until the physician arrives on the ground.

## Business and Personal.

The charge for insertion under this head is One Dollar a line for each insertion; about eight words to a line. Advertisements must be received at publication office as early as Thursday morning to appear in the following week's issue.

Marine Iron Works. Chicago. Catalogue free.  
For logging engines. J. S. Mundy, Newark, N. J.  
"U. S." Metal Polish. Indianapolis. Samples free.  
Yankee Notions. Waterbury Button Co., Waterbury, Ct.  
Handle & Spoke Mch. Ober Lathe Co., Chagrin Falls, O.  
Well Drill Prospecting Mach'y. Loomis Co., Tiffin, O.  
Improved Bicycle Machinery of every description. The Garvin Machine Co., Spring and Varick Sts., N. Y.  
Concrete Houses—cheaper than brick, superior to stone. "Ransome," 757 Monadnock Block, Chicago.

Machinery manufacturers, attention! Concrete and mortar mixing mills. Exclusive rights for sale. "Ransome," 757 Monadnock Block, Chicago.  
The celebrated "Hornsby-Akroyd" Patent Safety Oil Engine is built by the De La Vergne Refrigerating Machine Company. Foot of East 138th Street, New York.

The best book for electricians and beginners in electricity is "Experimental Science," by Geo. M. Hopkins. By mail, \$4. Munn & Co., publishers, 361 Broadway, N. Y.

Send for new and complete catalogue of Scientific and other Books for sale by Munn & Co., 361 Broadway, New York. Free on application.

## Notes &amp; Queries

## HINTS TO CORRESPONDENTS.

Names and Address must accompany all letters or no attention will be paid thereto. This is for our information and not for publication.  
References to former articles or answers should give date of paper and page or number of question.  
Inquiries not answered in reasonable time should be repeated; correspondents will bear in mind that some answers require not a little research, and, though we endeavor to reply to all either by letter or in this department, each must take his turn.  
Persons wishing to purchase any article not advertised in our columns will be furnished with addresses of houses manufacturing or carrying the same.  
Special Written Information on matters of personal rather than general interest cannot be expected without remuneration.  
Scientific American Supplements referred to may be had at the office. Price 10 cents each.  
Books referred to promptly supplied on receipt of price.  
Minerals sent for examination should be distinctly marked or labeled.

(7112) M. H. W. says: Will you kindly give me a recipe for removing nickel from steel, after the work is finished? It is removed by acids. Also please inform me object in coppering the steel before nickeling? A. Defective or old nickeling can be removed by first freeing from adhering dirt and grease; clean by plunging in a solution of caustic soda. The rust is next removed, which is best effected by connecting the article with a piece of sheet zinc and placing it in a mixture of 100 parts water and 1 part sulphuric acid until the rust spots have disappeared; or can be readily removed by wiping. The article is then dried and treated in the nitric acid bath. For the latter it is best to use a mixture of 1 part by volume of nitric acid and 10 parts by volume of sulphuric acid 66° B. The acid mixture should be kept in a vessel of glass, porcelain, or stone ware, or in a wooden trough lined with lead, and when not in use it should be covered. The articles to be stripped are placed in the acid bath and allowed to remain until the nickeling is completely dissolved. Should this not be the case in the course of an hour, the articles are taken from the bath by means of an iron tool, rinsed quickly in running water to remove the nickel salts not soluble in the acid, and then dried with cloths. They are then placed in the acid. When the nickeling is entirely dissolved, the articles are rinsed in water and brought immediately into the nickel bath; or if they are to be coppered before nickeling, as is frequently done, they are put into a cyanide of copper bath. The above is from Langbein's "Electro Depositions of Metals," \$4. The object of coppering steel before nickeling is to prevent its rusting, and also to give a better hold for the nickel on the baser metal. The nickel is then not so liable to scale off.

(7113) C. G. S. says: Would you kindly tell me the best paste to use for labeling bottles where the bottles are exposed to the wet? A. Labels which are exposed to the wet should be varnished, after the paste is dry, with copal varnish. 1. Tragacanth, 1 ounce; gum arabic, 4 ounces; water, 1 pint. Dissolve, strain, and add thymol, 14 grains; glycerine, 4 ounces, and water to make 2 pints. Shake or stir before using it. 2. Rye flour, 4 ounces; alum, ½ ounce; water, 8 ounces. Rub to a smooth paste, pour into a pint of boiling water, heat until thick, and finally add glycerine, 1 ounce, and oil of cloves, 30 drops. 3. Rye flour, 4 ounces; water, 1 pint. Mix, strain, add nitric acid, 1 drachm, heat until thickened, and finally add carbolic acid, 10 minims; oil of cloves, 10 minims, and glycerine, 1 ounce. 4. Dextrin, 8 parts; water, 10 parts; acetic acid, 2 parts. Mix to a smooth paste, and add alcohol, 2 parts. This is suitable for bottles of wood, but not for tin, for which the first three are likewise adapted. 5. A paste very similar to 3, but omitting nitric acid and glycerine, is also recommended by Dr. H. T. Cummings—Am. Jour. Pharmacy. 6. A good paste for labels for specimens: Starch, 2 drachms; white sugar, 1 ounce; gum arabic, 2 drachms; water, q. s. Dissolve the gum, add the sugar, and boil until the starch is cooked. 7. A good paste is made by soaking flake tragacanth in sufficient cold water that the brush will not sink into the paste when finished. To prevent souring, add to the water 2 grains hydronaphthol (dissolved in a little alcohol) for each pint, and a few drops clove oil for scent. To keep away the flies add some oil of pennyroyal. Avoid, in making pastes, oil of wintergreen and carbolic acid, for these produce a purplish discoloration by contact with the tinned iron of the





Advertisements.

ORDINARY RATES.

Inside Page, each insertion -- 75 cents a line Back Page, each insertion ---- \$1.00 a line

The above are charges per agate line--about eight words per line. This notice shows the width of the line, and is set in agate type.

WOOD or METAL WORKERS without steam power can save time and money by using our Foot and Hand Power Machinery

AMERICAN PATENTS.—AN INTERESTING and valuable table showing the number of patents granted for the various subjects upon which petitions have been filed from the beginning down to December 31, 1894.

POWER & FOOT LATHES. SHAPERS, PLANERS, DRILLS, MACHINE SHOP OUT-FITS, COOLS AND SUPPLIES. CATALOGUE FREE

TRANSITS AND LEVELING INSTRUMENTS. NICKEL PLATED ELECTRIC LEVELS

Water Emery Tool Grinder Has no pumps, no valves. No piping required to supply it with water.

Bicycle Spoke Threading Machines Will roll thread on wire 3-16 inch diameter, one inch in length, and 1/4 inch standard thread 1/2 inch in length.

GATES ROCK & ORE BREAKER, Steam Ore Stamp, Mining Machinery, 50 years experience as builders.

THE ORNAMENTAL IRON INDUSTRY.—Description of the method of manufacturing wrought iron into ornamental and artistic forms.

POWER PRESSES for Cutting, Stamping, Wiring, and Lettering SHEET METAL BLANKS

ONLY ALL WROUGHT STEEL Shafting & Pulley in the world. Unbreakable, light, perfectly balanced.

WE LEAD ON WIRE COAT AND HAT HOOKS STEEL WIRE. "ACME" COAT & HAT HOOKS.

If You Are a Manufacturer of Sheet Metal articles, you are naturally interested in New Machinery, and it will cost only a 2c. stamp to request us to forward any of the following illustrated circulars:

PERFORATED METAL OF EVERY DESCRIPTION THE HARRINGTON & KING PERFORATING CO.

AUTOMATIC DROP PRESSES 33 1/3 INCREASE IN PRODUCTION. SEND ADDRESS FOR BOOK. MOSSBERG & GRANVILLE MFG. CO. PROVIDENCE, R.I.

Combination Pliers Drop Forging in all its branches done to order. Send us samples to figure on. Our work is equal to the best done in this country.

"Queen" Builder's Transit \$100 IMPROVED TRANSITS AND LEVELS Graduated entirely on our large dividing engines.

WELL DRILLING MACHINERY, MANUFACTURED BY WILLIAMS BROTHERS, ITHACA, N.Y.

ICE MACHINES, Cylinders, Engines, Brewers, and Bottling Machinery. THE VILTE MFG. CO., 839 Clinton Street, Milwaukee, Wis.

The Van Norman Universal Bench Lathe. A Lathe, Milling Machine, Screw Cutter and Universal Grinder in one tool.

Experimental & Model Work Circulars & advice free. Gardam & Son, 96 John St., N.Y.

Patents! MESSRS. MUNN & CO., in connection with the publication of the SCIENTIFIC AMERICAN, continue to examine improvements, and to act as Solicitors of Patents

Architecture To Carpenters, Machinists, Electrical Workers, Plumbers, Steam Fitters, Pattern Makers, Steam Engineers, Draughtsmen, Miners, Civil Engineers, etc.

Krueger's Automatic Self-Registering Lumber Measure Saves Time and Mental Wear and Tear. Avoids costly mistakes measuring lumber.

"WOLVERINE" GAS AND GASOLINE ENGINES, STATIONARY and MARINE. The "Wolverine" is the only reversible Marine Gas Engine on the market.

DO YOU USE POWER? All right; you need CHEAP Power. One Cent per Horse Power per Hour is CHEAP.

POWER? POWER?? POWER!!! Fifty per cent. increase at no additional expense. Victor Vapor Engine.

DYNAMOS FOR ELECTRIC LIGHTING. Special low prices to boom business. 8 light 16 c.p. 110 volt dynamo \$26.50

THE IMPROVED GAS ENGINE. Two cylinders in one casting. Occupies less space and weighs less for its power than any engine made.

ELECTRICAL SUPPLIES AT MANUFACTURERS' PRICES. Medical Battery, Finely Finished, 3 Currents, \$3.25 Guaranteed.

COMET ROCK BREAKERS. HEAVIEST DUTY. LIGHTEST THRUST. ONLY ADJUSTABLE CRUSHER MADE.

ARMSTRONG'S PIPE THREADING AND CUTTING-OFF MACHINES Both Hand and Power. Sizes 1 to 6 inches.

Model Locomotives Complete Sets Castings for Latest Design Express Locomotive N. Y. Central Pattern. Send for Catalogue.

SETS OF CASTINGS OF MODEL ENGINES CATALOGUES FREE. ALSO TOOLS, GEAR WHEELS & PARTS OF MODELS

1 and 1/2 H. P. Gas or Gasoline Engines. Well made, practical machine suitable for any kind of light work, and so simple that a boy can operate them.

ECO MAGNETO WATCHMAN'S ELECTRIC CLOCK. Indorsed by all Insurance Companies.

PATENT SCREW CUTTING TOOL Has been made and used for two years. Has few parts and can be manufactured cheaply.

Watchmaking a Trade for Young Men and Women Parsons' Institute for Watchmakers, Engravers and Opticians in New Quarters.

Scientific American which is the acknowledged leader of all publications in the world devoted to science and mechanical arts.



JUST PUBLISHED.

BICYCLES AND TRICYCLES

An Elementary Treatise on their Design and Construction. With Examples and Tables. By ARCHIBALD SHARP, B.Sc., Whitworth Scholar, Associate Member of the Institution of Civil Engineers, etc. With 565 Illustrations and Diagrams. Crown 8vo, \$4.00.

LONGMANS, GREEN & CO., Publishers, 91-93 FIFTH AVENUE, NEW YORK.

The New Models OF THE

Remington

NUMBER 6 Standard Typewriter NUMBER 7

embody the practical experience of years, and the guarantee of a long-established reputation.

WYCKOFF, SEAMANS & BENEDICT, 327 BROADWAY, NEW YORK.

Model House Painting

PATTON'S HOUSE PAINTING MODEL makes the selection of artistic, harmonious house color combinations simple and easy.

PATTON'S PURE LIQUID PAINTS (the model house paints). It is free of agents, or mailed for 10 cents.

JAS. E. PATTON CO., Milwaukee, Wis., U. S. A.

Low Rates to Washington for the Inauguration.

The B. & O. R. R. will sell round-trip tickets to Washington, D. C., from all stations on its lines east of the Ohio River, for all trains March 1, 2, 3, and all trains on the morning of the 4th that reach Washington not later than noon, at rate of two cents per mile in each direction, valid for return journey until March 8th inclusive.

Table with 2 columns: Station, Rate. Includes Philadelphia, Chester, Wilmington, Newark, Del.

and correspondingly low rates from other stations.

AUTOMOBILE CARRIAGES: THE Paris-Bordeaux-Paris Race of... Brief account of the performance of the vehicles that obtained the prizes in the competition instituted by the Petit Journal.

IMPERIAL BALL BEARING AXLE

A written guarantee with each set of axles. 97 PATTERN 8,000 sets in use. Indorsed by the leading carriage builders.

Write for our Illustrated Catalogue and Testimonials, which we send free on application. Imperial Ball Bearing Axle Dept., 184-190 Lake Street, Chicago, Ill.

Complete Volumes of the Building Edition of the Scientific American For the Year 1896.

The last Semi-annual Bound Volume, including the numbers from July to December, 1896, is now ready for delivery, and will be mailed, postpaid, for \$2.00.

Each yearly volume contains upward of two hundred examples of the latest and best designs for residences, ranging in cost from \$2,000 to \$20,000.

MUNN & CO., PUBLISHERS, 361 BROADWAY, NEW YORK.

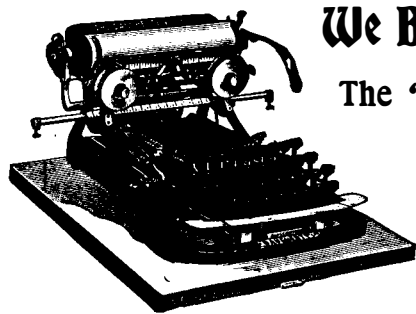

We Believe

The "DAUGHERTY VISIBLE"

Typewriter is the

Best on the Market

You can PROVE IT'S SO. Costs Express Only.

Catalogue of The Daugherty Typewriter Co.,

Locust and Main Sts., Kittanning, Pa.

NEW YORK AGENCY: C. C. W. Peck, 150 Nassau St.



The Typewriter EXCHANGE,

1 1/2 Barclay St., New York. 156 Adams St., Chicago. 38 Court Sq., Boston.

818 Wyandotte Street, Kansas City, Mo.

We will save you from 10 to 50 per cent. on Typewriters of all makes.

HOULTS AUTOMATIC TELEPHONE SWITCHES

Some of its advantages: 1st. It is strictly automatic. 2d. It completely does away with the "manual" switchboard.

MAIN LINE TELEPHONES This Telephone has 10,000 Ohm Magneto Bell. Standard Receiver and Electric or Battery Transmitter.

BUY TELEPHONES That Are Good--Not "Cheap Things"

The difference in cost is little. We guarantee our apparatus and guarantee our customers against loss by patent suits. Our guarantee and instruments are Both Good.

MAGNETO BELLS ALL KINDS OF PARTS TELEPHONES ELECTRICAL SUPPLIES

SUPERIOR TO COTTON WASTE Endorsed by First Under-writers. Safe, durable, cheaper. Agents wanted.

RAW SILK MACHINERY WIPERS Beware of loose woven imitations AMERICAN SILK MFG. CO.

ONLY PRACTICAL MAGAZINE CAMERA.

SUNART'S "VENI, VIDI VICI," SUNART MAGAZINE, SUNART FOLDINGS

WATER FOR COUNTRY USE. THE DOMESTIC PUMP. A wonderful invention for Raising Water.

HAWKINS' NEW CATECHISM OF ELECTRICITY A PRACTICAL TREATISE for Engineers, Electricians, Wiremen and Amateurs.

THE ERWIN HYDRAULIC MACHINERY CO., 58 & 59 Loan & Trust Bldg., Milwaukee, Wis.

WANT TO SUCCEED? Then use the NEW STYLE SUCCESSFUL INCUBATORS.

SAUMENIG! HATCHERS are made on best lines and of best material known to incubators.

KRAFTUBERTRAGUNGSWERKE RHEINFELDEN. Society for the Utilization of the Water Power of the Rhine N/Bale, Switzerland.

ALCO VAPOR LAUNCH Engine and Helm Controlled from Bow Latest improved and only 12 to 1 Motor now ready for the market.

MONITOR AND MOGUL MARINE GAS ENGINES. LAUNCHES NO INSPECTION, BOILER, FIRE, SMOKE OR OODOR.

Our Auxiliary Grookes Tubes are being accepted by scientists and professors for long life, strong rays, great penetration.

A. W. FABER Manufacturing Established 1761. LEAD PENCILS, COLORED PENCILS, SLATE PENCILS, WRITING SLATES, STEEL PENS, GOLD PENS, INKS, PENCIL CASES IN SILVER AND IN GOLD.

DORMAN'S VULGANIZERS are used all over the world. Exclusive Manufacturers of Steam Machines for Rubber Stamps.

COMPLETE ELECTRIC RAILWAY with battery and track. Car made of polished brass. A perfect working model.

SPRAYERS Have you read about THE COMET \$2.50 to \$5.00. Don't buy till you see them.

A GOLD DOLLAR is about the actual worth of our new book on Incubation and Poultry.

MONITOR INCUBATOR Illustrated Catalogue for stamp. Medal and Diploma awarded at the World's Fair.

A Hand Dynamo

Price \$1.75.

Suitable for Experimental Work.

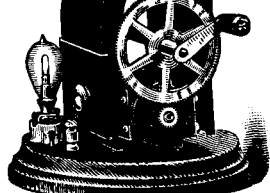

Lights a small incandescent lamp. Can be used as a Medical Battery. No induction coil necessary.

This is a Practical Machine, Not a Toy. Weight about 8 lb. Worth twice the money asked for it.

BOAT & MARINE ENGINES GRAND RAPIDS GAS ENGINE & YACHT CO.

CONTRACTS WANTED. To manufacture Hardware Specialties, Pat'd Novelties and Sheet Metal Stamping.

DEAFNESS & HEAD NOISES CURED. Our INVISIBLE TUBE Cautions help when all else fails.

\$5000 or not. Send 10 cents to cover postage and expense, and we will send plan and particulars.

FOR SALE CHEAP Second hand German and English wire nail machines.

EXPERIMENTAL MACHINE & MODEL WORK. First-class equipment. Secrecy guaranteed.

TANK LUGS and HOOP LOCKS The Dickey Mfg. Co. RACINE, WIS.

TELESCOPES W. & D. MOGEY, BAYONNE CITY, N. J.

BUCK BROS. Pattern Maker's Gouges, Woodworkers' Chisels, Gouges, Turning Tools.

X Ray Apparatus E. V. BAILLARD, 106 Liberty Street, N. Y.

CARBORUNDUM HARDEST ABRASIVE KNOWN. EMERY AND DIAMOND POWDER SUBSTITUTE.

PATENT FOR SALE on a Ruler which reduces the chances of blotting or blurring in ruling to a minimum.

WORTHLEY STALL WORKS 53 Elm Street, Boston, Mass. Have sold 9,000 of his Patent 25 lb. Slow Feed Oat Manger.

DIXON'S American Graphite Pencils Write the Smoothest and Last the Longest.

WOODEN TANKS. For Railroads, Mills and Manufactories. Builders of Steel Towers and Tanks.

LAUGHLIN FOUNTAIN PEN Guaranteed satisfactory or money refunded. Hard Rubber Holder, Ink, Gold Pen.

Japanese Patents. Citizens of the United States may now obtain patents in Japan.

Messrs. MUNN & COMPANY, 361 Broadway, New York City.

HYPNOTISM Sixty ways, \$5; my method, \$2, 100 page book, 10c. Oculist, 10c, 30c. Prof. Anderson, S. A. 27, Masonic Temple, Chicago

# \$1000 IN GOLD

will be paid in prizes for the best answers to examination papers containing 150 questions about things we all want to know. No acquaintance with the classics or higher mathematics required for this competition; a bright schoolboy or a clear-headed business man can do as well as a college professor. But these prizes can only be won by people who use

500,000 Definitions.  
150,000 Encyclopedic Articles.  
300,000 Quotations.  
8,000 Engravings.

## The Century Dictionary and Cyclopedia

10 Superb Volumes.  
The world's greatest Reference Work.  
An International Authority.

The award committee will consist of college professors whose names will be announced later.

You can obtain immediate possession of this great work in cash, and (with diligence) win one of the prizes (First Prize \$500.)

# For \$5 only

Send for a descriptive pamphlet of the work, or details of the competition, to

**THE CENTURY CO.** (Dept. S.A.) NEW YORK

## Nickel Silver Watches

We are casing all sizes of movements in this new metal. It takes a better finish and is more enduring than sterling.

It supersedes the old nickel plate, and enables one to have a perfect timepiece at small cost.

Our Solid Gold and Filled Cases, as well as Sterling Silver and Enameled patterns, are in greater variety this season than ever.

New specialties have been added.

Our '97 Model

### Trump Cyclometer,

the 10,000 mile wheel recorder, are all shown in our new catalogues, which will be sent to all.

The Waterbury Watch Co.  
WATERBURY, CONN.



The New Gold-Forged Screws  
MADE ONLY BY  
**AMERICAN SCREW CO.**

Patented May 10, July 19, '81; Oct. 29, '89; Aug. 10, Oct. 21, '90; April 7, May 12, '91; July 19, '92.  
FACTORIES: PROVIDENCE, R. I.; LEEDS, ENGLAND; HAMILTON, ONT.  
AGENCIES:  
New York, 94 Chambers St. Chicago, 19 Lake St.  
Baltimore, 14 W. German St. San Francisco, 23 Davis St.  
Philadelphia, 518 Commerce St. Boston, 36 Pearl St.

**JESSOP'S STEEL** THE VERY BEST  
FOR TOOLS, SAWS, ETC.  
WM. JESSOP & SONS, 19 JOHN ST. NEW YORK

## The American Bell Telephone Company,

125 Milk Street,  
Boston, Mass.

This Company owns Letters-Patent No. 463,569, granted to Emile Berliner November 17, 1891, for a combined Telegraph and Telephone, covering all forms of Microphone Transmitters or contact Telephones.

**THOROUGH INSPECTIONS**  
AND  
INSURANCE AGAINST LOSS OR DAMAGE TO PROPERTY AND LOSS OF LIFE AND INJURY TO PERSONS CAUSED BY  
**STEAM-BOILER-EXPLOSIONS**  
HARTFORD STEAM BOILER INSPECTION AND INSURANCE CO.  
CONN.  
J. M. ALLEN - PRESIDENT W. B. FRANKLIN - VICE PRESIDENT  
J. B. PIERCE - SECRETARY F. B. ALLEN - 2ND VICE PRESIDENT

At 1/4 Price Bicycles, Watches, Guns, Buggies, Harness, Sewing Machines, Organs, Pianos, Safes, Tools. Scales of all varieties and 1000 other articles. Lists free. Chicago Scale Co., Chicago, Ill.

**PHOTOGRAPHIC SIMPLICITY**  
Is embodied in the Pocket Kodak.  
**EASTMAN KODAK CO.**  
Rochester, N. Y.  
Booklet free at agencies or by mail.

**Free! Free!**  
THE ELASTIC TIP CO.'S New Invention Calendar will be mailed either from Boston, Chicago, or San Francisco, FREE, only send necessary mailing expense, five 2c. stamps.

**MANUFACTURE OF BICYCLES.**—A very comprehensive article giving the details of construction of every part of these vehicles. With 15 engravings. Contained in SCIENTIFIC AMERICAN SUPPLEMENT, No. 908. Price 10 cents. To be had at this office and from all newdealers.

# Have you seen the Victor Road Racer?

The date on it is January 20th, 1897. You will appreciate this date and its newness after you have seen the wheel.

It not only contains "Victor grade" material and "Victor grade" workmanship all the way through, but it has all the latest little touches which bring a bicycle up to date.

It has the latest fad—the new thing—which not only gives all that the past has suggested, but many points which are found nowhere else.

Expert road riders will fall in love with it.

In looking at it remember that the Company invites you to examine it bit by bit. In fact, this is our favorite way of showing Victor bicycles.

We believe in making riders intelligent concerning that which they are to buy.

See the Victor Road Racer with both eyes, both hands, both feet, before you buy a bicycle for '97. If you do, you will be glad of it.

Our catalog on application.

## OVERMAN WHEEL CO.

NEW YORK. BOSTON. DETROIT.  
DENVER. SAN FRANCISCO. PORTLAND, ORE.

P. S. Did you know that the Overman Wheel Co. built Safety Bicycles in '87, which was one year sooner than any other American bicycle maker? The Victor Road Racer is the concentrated experience of ten years in safety construction.

We are the oldest American makers of Safety Bicycles.

"Riverside" and "Royal" watch movements, made only by the American Waltham Watch Company, are as accurate time-keeping machines as human ingenuity has yet made possible. For sale by all retail jewelers in cases of any price desired.

## Cribne Bicycle

Tested and True.

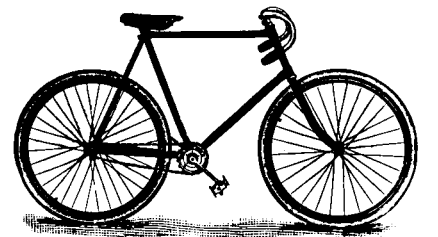

The Easiest Running Wheel in the World. Send for Catalogue.

THE BLACK MFG. CO., ERIE, PA.

### BRISTOL'S Recording Instruments.

Pressure Gauges, Vacuum Gauges, Voltmeters, Amperemeters, Wattmeters, and Thermometers, make continuous records Day and Night. Will pay for themselves. Every instrument fully guaranteed and sent on 30 days' trial. Send for Circulars and Specimen Chart. The Bristol Company, Waterbury, Conn.

### The Wheeler Reform Saddle



Built to Sit on, Not to Straddle. Shaped to afford the rider a natural support and overcomes all saddle soreness. Specially recommended for ladies. Indorsed by eminent physicians. A Practical saddle for all riders. Write for catalogue and be convinced. If your dealer cannot supply you, write the Wheeler Saddle Co., 191 Larned St. (E), Detroit, Mich.

### PRIESTMAN SAFETY OIL ENGINE

"A thoroughly successful commercial Engine using a Safe Oil."—Franklin Institute. No Extra Insurance, No Steam, No Gas, No Gasoline. Reliable, Safe, Economical, and Convenient. Chosen by Nine Governments. Used for nearly every purpose. PRIESTMAN & CO., Incorp'd. 330 Bourse Bldg., PHILADELPHIA, PA.

### THE CHARTER GASOLINE ENGINE

is used for almost every purpose power is applied to under the sun, and is unequalled. Full particulars by addressing CHARTER GAS ENGINE CO. Box 148, Sterling, Ill.

Highest Award at the World's Columbian Exposition.

The Rivett Lathe  
Faneuil Watch Tool Co., Boston, Mass., U. S. A.  
Greatest money making lathe is the Rivett.  
Finest tool for all kinds of fine nice work. INVESTIGATE!

Horse Carts 12 STYLES.  
NARROW & WIDE Tires. Wheels Popular Prices. Low rates of freight from our works, Tatamy, Pa., to all points. HOBSON CO., No. 4 Stone St., New York.

Send 10c. for Catalogue.  
Machinery, Tools, Inks and Type.  
**PRINTING OUTFITS**  
GOLDING & CO., 179 Ft. Hill Sq., Boston, Mass.

**PRINTING INKS**  
The SCIENTIFIC AMERICAN is printed with CHAS. BNEU JOHNSON & CO.'S INK, Tenth and Lombard Sts., Philadelphia, and 47 Rose St., opp. Duane, New York