

# SCIENTIFIC AMERICAN

[Entered at the Post Office of New York, N. Y., as Second Class matter. Copyrighted, 1894, by Munn & Co.]

A WEEKLY JOURNAL OF PRACTICAL INFORMATION, ART, SCIENCE, MECHANICS, CHEMISTRY, AND MANUFACTURES.

Vol. LXX.—No. 8.  
ESTABLISHED 1842.

NEW YORK, FEBRUARY 24, 1894.

\$3.00 A YEAR.  
WEEKLY.

## HOW TO MAKE A TELEPHONE CALL.

No telephone line is complete without a signal of some kind which will serve to attract the attention of a person in the vicinity of the instrument. A battery call answers very well for short distances, but for a distance of from one to twelve miles or more, the battery has been found impracticable and the magneto call is generally employed. This instrument not only serves a good purpose in connection with the telephone, but it answers very well indeed for general signaling purposes. It is always ready for action, and does not involve the care of a battery.

The line drawings presented herewith are one-half the actual size (linear measurement) of the instrument, and the perspective view is also one-half the actual size; the only dimension not obtainable from the drawings is the depth of the signal box, which is 3 inches. As all of the dimensions may be obtained from the engravings, it will be unnecessary to repeat them in the descriptive matter.

The pole pieces, A A', between which the armature, B, revolves, are formed of soft gray cast iron, with ears, a a, at the top and the ears, b, at the bottom, separated by bars, C C', of non-magnetic material, such as vulcanized fiber, hard rubber, or they may be made from hard wood, well varnished or saturated with paraffine to prevent them from shrinking or swelling. The pole pieces, A A', are clamped to the bars, C C', before they are bored out. They are bored out to loosely fit the armature, B'. The pole pieces are provided with flanges, c, which rest upon the bottom of the casing and are drilled to receive screws, d, by means of which the magnet is secured in place in the casing. In the pole pieces, A A', above the ears, b, are drilled and tapped holes, e, for receiving the studs, f, by which the horse-shoe magnets are secured to the pole pieces. The studs, f, are drilled for receiving keys, g, by which the magnets are clamped in place.

The compound magnet, D, is composed of three flat steel bars forming U-shaped magnets, h, h', h<sup>2</sup>, with the space between the poles adapted to receive the pole pieces, A A'. The magnet, h<sup>2</sup>, fits over the adjoining edges of the magnets, h h', and the three magnets are drilled to receive the studs, f, which extend through the magnets and into the pole pieces, the parts being clamped together by keys driven through the holes in the studs, as shown in the perspective view.

The armature, B, is the well known H type of Siemens, made of soft gray cast iron, the shaft, i, being cast integrally with the body of the armature. The part, j, which receives the wire is narrower and shorter than the polar extremities of the armature. The armature is turned so that its convex sides will revolve very near, but not in contact with the pole pieces. The shaft at the ends of the armature is turned, and to one end is fitted a sleeve, k, of insu-

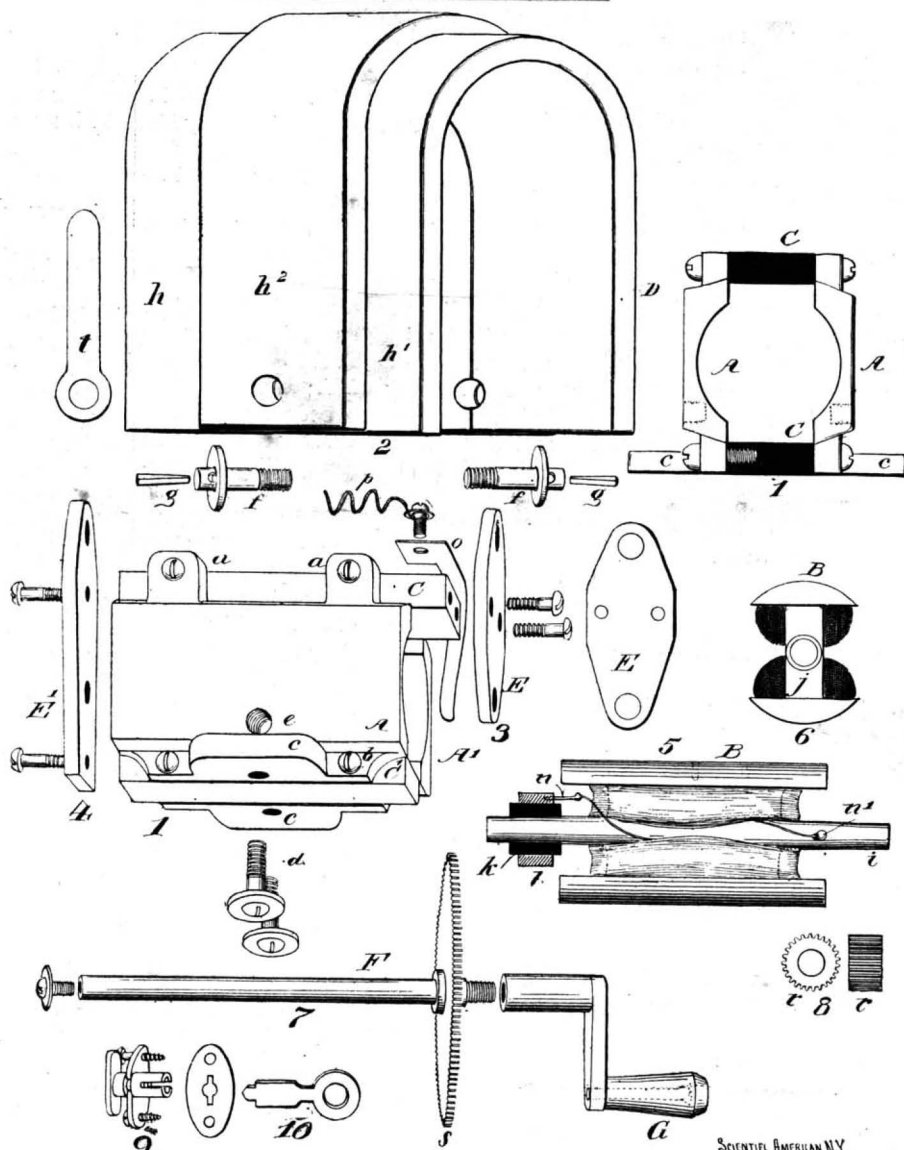

1. Pole pieces. 2. Field magnet. 3, 4. End plates. 5. Armature, side view. 6. Armature, end view. 7. Driving shaft. 8. Pinion. 9 and 10. Door lock and key.

### DETAILS OF MAGNETO CALL—THE GENERATOR.

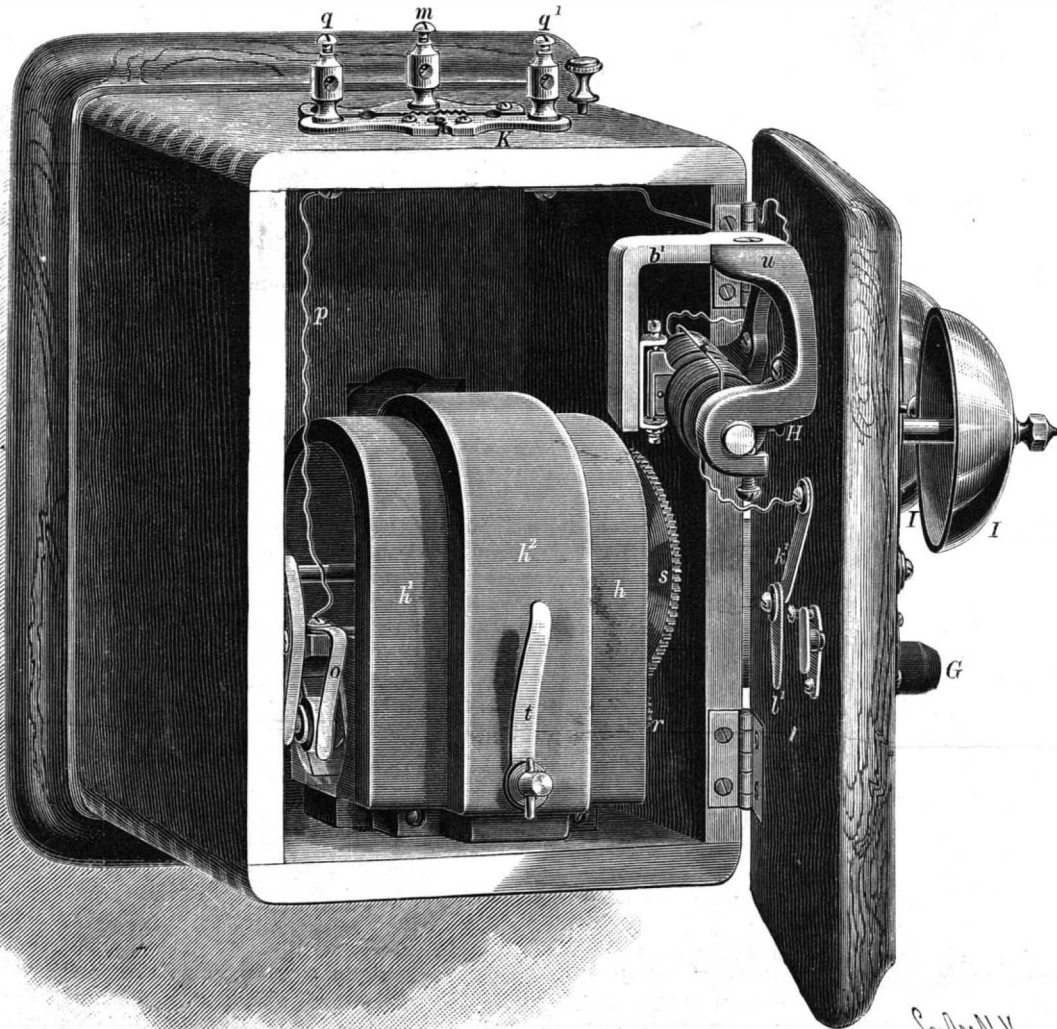

MAGNETO TELEPHONE CALL.

lating material (vulcanized fiber or hard rubber), on which is placed a brass ring, l. In the inner side of the metallic ring, l, is inserted a stud, n, to which is soldered one terminal of the armature coil, the other terminal of which is soldered to a screw, n, inserted in the shaft, i. The armature is wound in the same manner as an electro-magnet, the wire being carried around one arm of the armature until one-half of the wire is in place. It is then carried across the central portion of the armature and wound upon the other arm of the armature. The wire used is No. 34 silk-covered wire, there being about 1½ ounces of wire upon the armature, or enough to give it a resistance of 200 ohms.

To the bar, C, is secured a brass plate, E, by means of screws which pass through the plate and into the bar. In the plate, E, opposite the center of the bore of the pole pieces, there is a bearing for one end of the shaft of the armature, and in the opposite or upper end of the brass plate, E, there is a bearing for the driving shaft, F. To the opposite end of the bar, C, and to the bar, C', is secured a plate, E', which is also provided with bearings for the armature shaft and for the driving shaft. To the bar, C, is secured a curved spring, o, which bears upon the insulated ring, l, and this spring is connected by a wire, p, with a binding post, q, at the top of the casing.

Upon the end of the armature shaft, i, outside the plate, E', is placed a pinion, r, and upon the shaft, F, is placed a spur wheel, s, which engages the pinion, r. The shaft, F, is held in place in the machine by a screw inserted in the end of the shaft, and a washer held by the screw against the end of the shaft and bearing against the plate, E. The crank, C, by which the shaft, F, is turned, is screwed onto the end of the shaft through an aperture in the side of the casing. On the stud, f, projecting through the front of the magnet is placed a contact spring, t, which is clamped by the key which holds the magnet in place.

The mechanism thus described comprises the magneto generator which generates the alternating current required for operating the magneto bell. The machine is held in place in the casing by the screws, d, as already described, and the back of the casing is cut away to let the magnet, h<sup>2</sup>, into the back, thus economizing room. To the cover of the casing is attached the magneto bell, H, the magnet and armature of which are placed within the door, while the bells are placed on the outside of the door, the hammer extending through the door and between the bells.

The body of the magneto call consists of a curved casting, u, which is secured to the inner face of the door and provided with loops, v v', for receiving the soft iron pole pieces, w w', of the bell magnet. These pole pieces are held in place in the loops v v' by screws passing through

(Continued on page 118.)

Scientific American.

ESTABLISHED 1845.

MUNN & CO., Editors and Proprietors. PUBLISHED WEEKLY AT No. 361 BROADWAY, NEW YORK.

O. D. MUNN. A. E. BEACH.

TERMS FOR THE SCIENTIFIC AMERICAN.

One copy, one year, for the U. S., Canada or Mexico... \$3 00 One copy, six months, for the U. S., Canada or Mexico... 1 50 One copy, one year, to any foreign country belonging to Postal Union... 4 00

The Scientific American Supplement

is a distinct paper from the SCIENTIFIC AMERICAN. THE SUPPLEMENT is issued weekly. Every number contains 16 octavo pages, uniform in size with SCIENTIFIC AMERICAN. Terms of subscription for SUPPLEMENT, \$5.00 a year, for the U. S., Canada or Mexico. \$6.00 a year to foreign countries belonging to the Postal Union. Single copies, 10 cents. Sold by all newsdealers throughout the country. See prospectus, last page.

Building Edition.

THE ARCHITECTS AND BUILDERS EDITION OF THE SCIENTIFIC AMERICAN is a large and splendid illustrated periodical, issued monthly, containing floor plans, perspective views, and sheets of constructive details, pertaining to modern architecture. Each number is illustrated with beautiful plates, showing desirable dwellings, public buildings and architectural work in great variety. To builders and all who contemplate building this work is invaluable. Has the largest circulation of any architectural publication in the world.

Spanish Edition of the Scientific American.

LA AMERICA CIENTIFICA E INDUSTRIAL (Spanish trade edition of the SCIENTIFIC AMERICAN) is published monthly, uniform in size and typography with the SCIENTIFIC AMERICAN. Every number of LA AMERICA is profusely illustrated. It is the finest scientific, industrial trade paper printed in the Spanish language. It circulates throughout Cuba, the West Indies, Mexico Central and South America, Spain and Spanish possessions—wherever the Spanish language is spoken. \$3.00 a year, post paid to any part of the world. Single copies 25 cents. See prospectus.

The safest way to remit is by postal order, express money order, draft or bank check. Make all remittances payable to order of MUNN & CO. Readers are especially requested to notify the publishers in case of any failure, delay, or irregularity in receipt of papers.

NEW YORK, SATURDAY, FEBRUARY 24, 1894.

Contents.

(Illustrated articles are marked with an asterisk.)

Aerial vessel, Spaeth's\*... 116 Afghanistan, the, four-masted ship\*... 121 Algebraical fallacy, an (5807)... 124 Bean oil... 114 Billroth, Theodore... 114 Canal works in 1893... 117 Carbonic acid in air... 114 Conduits, underground, in N. Y... 123 Distilling apparatus, a family\*... 119 Ecuador, American trade in... 121 Electrical devices, some new... 123 Electric current collector for dynamos, Roberts\*... 117 Fishing, winter, on Lake Erie... 119 Furnace, a small blast (5804)... 124 Gases, occluded, in coal... 114 Grafts, natural... 119 Gravity, experiment in... 123 Gunpowder and explosives... 118 Ice house and cold storage (5808)\* 124 Ink fountain, Moore's chromatic\* 116 Inventions, recently patented... 123 Lac industry, Bengal... 115 Lathing, metallic, Eckstein's\*... 116 Leather staining... 118 Log chute, a great... 119 Manganese in Colombia... 117 Medicine, preventive... 122 Oil fuel... 114 Optical illusion, an\*... 122 Oranges, Florida... 114 Patent granted, weekly record... 125 Photographic chemicals, injurious... 123 Planet notes for March... 115 Reservoir, a 60,000 gallon (5803)... 124 Saltion Sea, the... 119 Schaeffler's experiments on... 118 Ship Builders' Academy and Home, the Webb\*... 120 Silkworm, a new... 118 Street car propulsion prize... 114 Sugar beet items, Germany... 122 Sugar lands, Florida... 119 Schaeffler's compass (5805)... 124 Telephone call, how to make\* 113 Tramway, wire, in the Alps... 123 Valve, relief, Harrison's\*... 117 Watches, low priced\*... 116 Webb, W. H.\*... 120 Yellow fever... 122

TABLE OF CONTENTS OF SCIENTIFIC AMERICAN SUPPLEMENT No. 947.

For the Week Ending February 24, 1894.

Price 10 cents. For sale by all newsdealers.

L. AERONAUTICS.—The Internal Work of the Wind.—By S. P. LANGLEY.—The application of Professor Langley's investigations to artificial flight.—Conclusion of this most valuable contribution to the subject.—3 illustrations... 15137 II. AGRICULTURE.—Comparative Value of Manures for Potatoes.—An investigation of manures for potatoes, and results obtained under different circumstances... 15142 III. ARCHITECTURE.—Cellar or no Cellar?—By EDWARD ATKINSON.—The advantage and disadvantage of a cellar from a sanitary standpoint... 15134 Fireproof Flooring.—The different methods of laying fireproof floors, with sections thereof.—53 illustrations... 15132 IV. BOTANY.—How Plants Feed.—The absorption of nutriment by plants popularly described... 15141 V. CHEMISTRY.—Alloys.—By Prof. W. CHANDLER ROBERTS-AUSTEN.—Continuation of Prof. Roberts-Austen's exhaustive work, giving several analyses and properties of alloys... 15136 Analysis of Smokeless Powder.—By C. ISTRATI.—Examples of analysis of a smokeless powder, with results... 15137 A New Sulphide of Carbon.—By A. R. DUTTON.—A liquid sulphur-carbon compound.—Its characteristics and discovery... 15135 Nitrogen as Food for Animals and Plants.—By VAUGHAN CORNISH.—Assimilation of plants and dynamo.—A curious chemical investigation... 15135 Tests for Cocoon and Palm Oil.—Detection of impurities in these oils... 15136 VI. CIVIL ENGINEERING.—Carriageway Pavements.—Notes on pavements and on the production of improved roads in cities... 15129 VII. CYCLING.—The Valere Running Machine.—A novelty in wheeling employing hands and feet for progression.—2 illustrations... 15130 VIII. DECORATIVE ART.—How to Make Statuary in Paper.—Interesting article on decorative art.—2 illustrations... 15129 IX. ENTOMOLOGY.—Those Cocoons Resembling Pine Cones.—By Prof. C. V. RILEY.—A popular article by Prof. Riley on the curious cocoons lately described in the SCIENTIFIC AMERICAN.—4 illustrations... 15139 X. HORTICULTURE.—Chrysanthemum John Noble.—A magnificent chrysanthemum.—A recent English seedling.—1 illustration... 15141 XI. MICROSCOPY.—Report of the Microscopist of the Department of Agriculture.—Interesting notes on microscopic work.—3 illustrations... 15135 XII. MINING ENGINEERING.—The Gold Deposits of the Pyrenees.—How gold was worked in the Pyrenees in the last century.—1 illustration... 15140 XIII. MISCELLANEOUS.—Metallic Lantern Screens.—By W. H. HARRISON.—Dead metallic screens for magic lantern work... 15131 The Jinriksha at Home.—The man-propelled vehicle of Japan.—1 illustration... 15134 XIV. NATURAL HISTORY.—Pila Marina.—Curious marine formations and how produced.—3 illustrations... 15141 The Condor of the Andes.—By S. L. CLAYES.—A popular and graphic description of the great South American bird... 15140 XV. PHOTOMETRY.—Method of Making Standard Sperm Candles.—Details of the making of sperm candles for photometric tests by the referees... 15128 XVI. PYROTECHNY.—The Manufacture of Fireworks in France.—An interesting article on the manufacture of the most improved fireworks.—4 illustrations... 15127 XVII. TECHNOLOGY.—Adulterated Linseed Oil.—Notes on the adulteration of oil by the jobber and smaller manufacturers.—How to detect it... 15128 Improved Planing Machine.—A machine of improved construction for metal working.—3 illustrations... 15131

THE FIFTY THOUSAND DOLLAR REWARD FOR STREET CAR PROPULSION.

In our paper for December 23, 1893, we gave the text of the offer made by the Metropolitan Traction Company of this city, to pay a reward of fifty thousand dollars to any person who should submit to the New York State Board of Railroad Commissioners, on or before March 1, 1894, an actual working system or motive power for street railway cars, demonstrated to be superior or equal to the overhead trolley, the qualities necessary to meet this requirement to be decided by the Board; but the winning system to approximate in economy of operation to the trolley, and to be free from those features of the trolley that are objectionable to the public. The Traction Company also agreed to pay any necessary expenses of the Board in regard to making experiments, employing experts, giving hearings, etc. This offer appears on its face to be very generous, especially as the Traction Company disclaimed all purpose of controlling or owning the patents for the approved new system, if any should be adopted.

As a result of this public offer the Traction Company has been overwhelmed with correspondence and with new plans for propelling street cars, insomuch that the Company was obliged to issue a circular letter to applicants, stating that all plans and matters relating to the invention called for should be submitted to the Commissioners at Albany, N. Y.; and we understand the Commissioners have also been overstocked with plans. This is rather remarkable, especially when the brevity of the time allowed to competitors is considered, namely, December to March, three months. But inventive genius is prompt and responsive, especially when a fifty thousand dollar prize like this is clearly in view.

The Board of Commissioners, when they came to consider what form their official action should take in the premises, satisfied themselves they had no lawful power to act to decide upon the plans and make the award.

They, therefore, applied at once to the State Legislature, asking the passage of a law authorizing them to accept and act upon the Traction Company's offer. It is expected the necessary legislation will soon be granted, in which case all plans filed with the Commissioners up to March 1 will be passed upon. The result is looked forward to with much interest by all the competitors. Even if none succeed, if none of the plans are found to meet the conditions required, the stimulus produced by the offer of the reward will not be without value. It has set many minds upon the study of the problem, and doubtless numbers of new inventions will be the result. The mental effort of reaching out for something new in a particular direction is very apt to lead into additional lines of discovery.

Oil Fuel.

An interesting report on the results of using oil fuel at the Chicago Exhibition has been presented to the Standard Oil Company by Mr. Charles F. Foster. This statement avers that the use of oil as fuel has been entirely satisfactory in every particular. During the period the Exhibition remained open, the main boiler plant consumed 10,614,401 gallons, or 74,300,805 pounds of oil for generating steam; developing the aggregate energy of 32,315,964 horse power hours, at a cost of 6.3 mills per horse power hour. The contract price for the oil delivered in the Exhibition tanks was 72 1/2 cents per barrel of 42 United States standard gallons. The boiler house force and equipment comprised 210 burners, atomizing oil beneath 52 boilers with a standard rating of about 21,000 horse power, and attended by a staff of 42 men divided into three eight hour shifts. The saving in cost of both fuel and labor for the oil fuel, as compared with coal of fair quality at market price for large quantities, is apparent. An equivalent consumption of from 500 to 600 tons of coal per day would have been necessary, so that for the duration of the Exhibition 70,000 tons of coal would have been needed; and Mr. Foster remarks that "it would be difficult to imagine how this vast amount of coal would, in the limited space available, have been handled expeditiously and without endangering life and property." The saving to the Exhibition by the use of oil fuel was about 27 per cent as compared with the estimated cost of coal, including the labor of handling. The oil plant worked from start to finish without a break; and the smokelessness and absence of odor from the chimneys of the boiler house were made a subject of general comment.

Dr. Carl Otto Weber states that in the use of liquid fuel Russia appeared to be in advance of all other countries. During the coal strike many Manchester firms had recourse to petroleum as a fuel, but the results in every instance seemed to have been discouraging. In Russia it was only the heavy petroleum residues (astatki) which were used for boilers, railway engines, and similar purposes. Astatki on combustion produced 11,000 cal. as against about 8,000 cal. obtained from first class steam coal. It appeared, therefore, that in this respect 62 pounds of astatki were equal to 100 pounds of coal. By working side by side two

boilers of the same type, firing the one with coal, the other with astatki, it was found that 1 pound of coal evaporated 8 pounds of water and 1 pound of astatki 13 pounds of water. The relation between the volume of air passing into the furnace and the quantity of water evaporated was also important; and it was found that for 1,000 cubic feet of air consumed, coal evaporates 1.5 and astatki 2 pounds of water. Consequently, besides a smaller weight of fuel, also about 20 per cent less heating surface was required for astatki fires. This was apart from the cost of the fuel, an item of considerable importance for marine boilers, as it would allow to reduce their volume very considerably without lessening their steam producing capacity.

The works in and around Moscow used in 1890 about 100,000 tons of astatki at a saving of about 30 per cent as compared with coal. The price of the residue at Moscow is \$25 per ton; at Baku no more than \$2.50.

Florida Oranges.

A correspondent, writing from Marion County, Fla., says:

"The Florida orange crop, it is thought, will be little larger than ever before. It was estimated at from 4,000,000 to 4,500,000 boxes. A storm that prevailed in October over the eastern part of the State has shortened the crop considerably. In some places the estimate of damage was as high as 25 per cent.

"The great hurricane that desolated the Louisiana and Mississippi coasts destroyed most of the Louisiana crop. A company of Florida packers had gone to Louisiana to pack the crop on the Bradish Johnson place, near the mouth of the Mississippi River. The crop on that grove was estimated at from 30,000 to 40,000 boxes. They got off 3,000 boxes before the storm came. It destroyed all that was left on the trees, and blew down several thousand of the trees. Parenthetically, I will say that Florida enjoys a happy immunity from severe storms. Cyclones are unknown and hard winds rare.

"The product of oranges has increased in the last eight years from 600,000 to 4,000,000 boxes, and that amount is about as much as can be marketed at a profit. We know this from the experience of the last two seasons. Production is increasing more rapidly than the demand. Unless some great disaster overtakes the orange groves, it will not be many years before production reaches 10,000,000 boxes. The crop is very fine. There has been no lack of rain this season, and greater pains have been taken to improve the quality of the fruit by more spraying, more fertilizing, and better cultivation. As the groves increase in age and productiveness, so, it seems, with greater pace increase the diseases and parasites that infest them. In this way an effectual check to overproduction may result.

"For the blight no remedy has been found. Foot rot is amenable to treatment, but is destroying thousands of trees annually. The scale pursues the even tenor of his way. Checked he may be, but never subdued by treatment. One of my neighbors, who expects to market 30,000 boxes this season, spent this year \$3,000 for kerosene used on his trees."—The Country Gentleman.

Occluded Gases in Coal.

Mr. W. McConnell, of the Durham (England) College of Science, has been studying the gases occluded in the coal found in a number of the collieries in the Durham field. The coal is bituminous and used for gas and steam.

Mr. McConnell put the coal into a glass apparatus which was heated in a bath to a temperature of from 100° to 180°. From this the occluded gases were pumped into a holder and afterward analyzed and measured. From one colliery the coal was found to contain occluded free hydrogen, marsh gas, ethane, and other members of the paraffin series of hydrocarbons as far as pentane. Crushing the coal to powder and subjecting it to a temperature of 180° under reduced pressure, it still retained free oxygen, the higher members of the paraffin series, and a less quantity of olefines in the occluded state. The experiments seem to indicate clearly that coal dust is readily ignited because of its retention of the occluded hydrocarbons.

Theodore Billroth.

The celebrated German surgeon, Dr. Theodore Billroth, died at Abbazia, the Austrian winter resort, of heart disease on February 7. Dr. Billroth was born on the island of Rügen in 1829, and was educated at the universities of Greifswald, Göttingen and Berlin. He rendered distinguished services to the cause of science as professor in the universities of Zurich and Vienna. His most celebrated discoveries were the operation for the extirpation of the larynx, excision of cancer of the stomach, and the treatment of wounded soldiers. Dr. Billroth was very careful in his selection of students, and some of the best surgeons of Germany, Belgium, Austria and America mourn the loss of their great master. A brief biographical notice of Dr. Billroth with a portrait will be found in our SUPPLEMENT 483.



Planet Notes for March.

H. C. WILSON.

*Mercury* during March will be passing between the earth and the sun, as may be seen from the diagram in our last number, page 71. For the first two or three days the planet will be visible in the evening just after sunset. In order to see it one must look toward the west, just a little above the horizon. On March 14, 2 h. 18 m. A. M., Mercury will be in conjunction with the sun, and after that time it will be morning planet.

*Venus* will be morning star and rapidly come out from the rays of the sun. She will increase rapidly in brilliancy, so that none can mistake her, greatest brilliancy being attained on the 22d of March. Venus will be in conjunction with the waning moon, 12° 28' north, March 4, at 9 h. 38 m. P. M. central time.

*Mars* rises about 4 o'clock in the morning, and is at such a southern declination that there will be little opportunity for observation of this planet in northern latitudes during March. It is in the constellation Sagittarius and moving eastward. Mars will be in conjunction with the moon, 4° 44' north, March 1, at 11 h. 20 m. P. M., and again March 30, at 11 h. 38 m. P. M.

*Jupiter* will be in good position for observation in the early evening. His position, southwest of the Pleiades, is so well known by this time that it needs no mention. His motions during March will be eastward. Jupiter will be in conjunction with the moon, 4° 40' south, March 11, at 2 h. 40 m. P. M.

*Saturn* rises in the evening and will be in good position for observation after midnight. For the position of this planet in the constellation Virgo see the chart in our last number. Saturn will be in conjunction with the moon, 4° 24' north, March 23, at 3 h. 1 m. A. M.

*Uranus* is in the constellation Libra, southeast from Saturn (see chart, page 73), and may be observed after midnight. Uranus will be in conjunction with the moon, 3° 39' north, at 6 h. 12 m. P. M., March 24.

*Neptune* will be in good position for observation during the early evening in March. The position of this planet in Taurus is unchanged from last month.

The asteroid *Juno* is in the constellation Libra, about 5° northeast of the star  $\beta$ . It is making the turn of the loop in its apparent path, and after the middle of the month will move westward.—*Astronomy and Astrophysics.*

The Bengal Lac Industry.

Lac or gum lac is a substance produced in Bengal on the leaves and branches of certain trees by a small insect, the *Coccus ficus*. The trees selected are principally the *Ficus indica*, *Ficus religiosa*, and *Rhamnus Jujuba*. There are three kinds of lac known in commerce, distinguished by the names of stick lac, seed lac, and shellac. Stick lac is the substance in its natural state; it is of a reddish color and incrusts small twigs. When broken off and boiled in water it loses its red color, and is then termed seed lac, and when melted and reduced to the state of thin sheets it is called shellac, which has a yellowish-brown color. The French representative at Calcutta has recently reported upon the present condition of the lac industry. He states that the finest descriptions are found in Assam and Bengal, and that coming from the former is a very important article of trade. Lac from Burma, which is chiefly produced in the upper districts and the Shan States, is sent to Calcutta to be worked up. Burma, it is stated, is in a position to supply endless quantities of lac, as the vast forests there contain so many descriptions of trees well adapted to its development. The districts of the Punjab and Mysore are large producers of lac, which is chiefly used at the place of production, its inferior quality rendering it unfit for exportation. Then come Bengal, Oudh, Scinde, and the Central Provinces, which yield lac. According to quality, it is sent to Calcutta to be melted, or to certain towns of the interior, such as Hyderabad and Mirzapore, for working up into bangles and other articles. There are large numbers of factories in India, but the greater part are of little importance, and only turn out products of very second-rate quality. The methods of manufacture vary according to district. Lac dye is used to a very considerable extent in dyeing. It is, however, in connection with furniture making that the largest quantity of lac is used, and this industry has of recent years made considerable progress in the provinces of Scinde and the Punjab. In making the furniture, a very light wood is used, which contains no resin and which can be easily worked. This wood is obtained from a species of poplar tree, and takes the lacquer easily. Lac is also used in making trinkets, such as bangles, rings, and other ornaments, which are worn by the women of the poorer classes. In Burma, it is used in fastening sword blades in their handles, and in certain districts it is used in making whetstones by mixing a portion of powdered lac with three parts of river sand. In hat making, a mixture of lac, mastic pounce, and other resins, dissolved in alcohol, is used to stiffen silk hats, and in lithography lac is used in connection with the preparation of the ink. Mixed with resin and certain coloring material, it makes

sealing wax. Lac also enters into the composition of numerous varnishes. In adding to a solution of lac in alcohol, a yellow clear substance such as gum gutta, saffron, etc., a liquid is obtained which gives to copper and other metals the appearance of gold, while still preserving their brightness. Lac may be adulterated by the addition of resin, and this frequently happens in the case of lac of native preparation, and the proportion of resin sometimes amounts to as much as 25 per cent. Its presence is easily recognized by the smell when a piece of lac is broken between the fingers. The quantity of lac exported in 1892-93 amounted to 125,246 cuts, valued at 7,787,583 rupees. In the preceding year the value amounted to 7,444,460 rupees. The principal customers for lac are first England, and then the United States, Germany, France, Austria, Australia, etc. The exports of lac dye appear to have entirely ceased during the last four years.

Canal Works in 1893.

The year 1893 witnessed the completion of the Corinth Canal, a work which may be said to have been in contemplation for the last 2,400 years. The *Engineer*, London, says surveys and borings were actually made, and the work partially commenced, in the reign of the Emperor Nero. The work remained in abeyance till the success of the Suez Canal led to the scheme assuming a practical shape in 1881; and after overcoming several financial difficulties, the canal was opened for traffic in August last. The length of this canal is only four miles; but the undertaking has been costly, the cutting being principally through rock.

The Manchester Ship Canal was completed during the year, and its opening for traffic was a most notable event. The weather during the year was very favorable to the progress of the works, which were hindered, as in previous years, by interruptions caused by floods and tempests. The principal works completed during the year were those for the deviation of the London and Northwestern and Great Western Railways, the opening of these deviations first for goods traffic and later on for passengers. When this was accomplished there remained the cutting through the site of the old lines. The final completion of this part of the work was considerably delayed by the settlement of the claims of the companies for compensation, which, however, in the end resulted in a favorable award to the canal company, the amount they had to pay being only about one-fourth of that claimed. Several large swing bridges and the swinging aqueduct at Barton were also completed during the year. The other principal works which have been brought to a successful termination are the embankment of the Mersey, near Runcorn, and the underpinning of Runcorn Bridge. At the end of November the water was let into the last section of the canal, and on December 7 the first steambot passed from the Mersey at Eastham to Manchester. The canal was traversed in 6¼ hours, although there were delays, owing to several of the bridges and the Barton Aqueduct being swung by hydraulic power for the first time. The works were commenced on November 11, 1887, and thus this great undertaking has been completed in the short space of seven years. Meantime, on the lower reach of the canal, business has been rapidly growing, and Saltport, which a year ago hardly had an existence, is now a busy port. From the commencement of 1894, steamers from America will proceed direct to Manchester, and arrangements have been made by different companies for regular traders to Amsterdam, Rotterdam, Antwerp, Dunkirk, Terneuzen, Hamburg, London, Belfast, and other ports.

No further progress appears to have been made for carrying out the Sheffield and South Yorkshire Navigation scheme, and the junction of this system of canals with the Aire and Calder. The scheme, however, is not dead, as a notice has been given by the company of their intention to apply to Parliament for powers to obtain land beyond that which is to be given over by the railway company. The amount to be paid for the existing canals, which is to be determined by the railway commissioners, has not been settled.

The Panama Canal still remains in a state of ruin. An extension of the concession has been obtained from the Colombian government up to October, 1894, and attempts have been made to form a new company to go on with the work, but so far without success. The Nicaragua Canal is also in difficulties. Owing to the state of financial matters in America, it was found impossible to raise money to go on with the work, and in order to protect the works and plant, the Nicaragua Canal Construction Company was placed in charge of a receiver. The company has expended about £800,000 for property, work, labor, and materials, and has, as elsewhere mentioned, recently been reconstructed. The works of the Chignecto Ship Railway Company have been also at a standstill for more than a year, and are going to ruin for want of funds. Over a million of money has been spent, and it is estimated that it will require another half million to complete the railway.

The North Sea Baltic Canal has been making considerable progress, about 5,000 men being employed, one-half of whom are housed in barracks erected by the canal authorities. A large number of the men are

Swiss and Italians, these men being preferred on account of their sober habits. Up to the present time about 100 million cubic yards of earth have been moved. At Holtenau the locks are in working order, and some of the large bridges for carrying the roads and railways over the canal are completed. The estimated cost of this canal is £7,800,000, and it is expected it will be completed in 1894—seven years after its commencement.

Abroad several important works for improving ports and harbors have been completed during the year. At Tunis a new channel has been opened, from the gulf to the town.

At Alexandria a new straight and deep channel has been made to the port.

Several important works for the improvement of the harbor of Bilbao have also been completed; and also at the port of Lido, for improving the navigation to Venice.

In America, the works for connecting Chicago with the Mississippi by means of a canal joining Lake Michigan with the Illinois River are progressing. It is considered that this canal will, for all practical purposes, place the Mississippi cities a thousand miles nearer the Atlantic seaboard, and double the value of the Western lands. The canal on the Canadian side of St. Mary's River, for giving communication between Lakes Huron and Superior, and allowing vessels bound for the St. Lawrence to pass this way instead of through the Sault Ste. Marie Canal, is expected to be completed in July, 1894. This canal is 3,500 ft. long, and will have a lock 900 ft. long, 60 ft. wide, with 19 ft. of water on the sill. The United States at present charge 20 cents per ton on all freight passing through the Sault Ste. Marie Canal and going to any port in the Dominion of Canada, vessels going to the States passing through free. The importance of completing the works, so as to give Canada the control of the great waterway from Lake Superior to the St. Lawrence, is obvious.

At Montreal the works for the improvement of the harbor and the shipping accommodation have made good progress. These consist of a guard pier 1½ miles long, 45 ft. wide at top, and 20 ft. above low water, extending from the abutment of the Victoria Bridge down stream, for the purpose of protecting the harbor from the floods and the ice. This pier will inclose a basin of 250 acres. The material dredged and excavated from the basin is used for the construction of the pier. Inside this harbor extensive wharves are to be erected. The pier will require about a million cubic yards of materials, of which about one-third is already in place. The estimated cost of this work is £624,000, and it is expected that it will take three years to complete.

Florida Sugar Lands.

Mr. S. A. Jones, in an article in the *Tampa Times*, makes some statements in respect to sugar lands in Florida that will surprise those who have been accustomed to think of that State only in connection with oranges and early vegetables. He says that it has been shown by careful surveys that in Florida there are 4,000,000 acres of the richest land in the world, capable of producing from 4,000 to 6,000 pounds of sugar per acre, and that the whole body of this land can be brought under cultivation for \$20,000,000. In his opinion the continuance of the two cents a pound bounty on sugar or a tariff of two cents a pound would insure the reclamation of all this land by private capital and enterprise, or, if both the bounty and tariff are denied, an appropriation of \$20,000,000 by the government would prepare for cultivation an amount of land sufficient to produce four times the amount of sugar at present consumed in this country. This is a surprising statement, but there is no doubt Mr. Jones is sincere in making it.

According to his figures there are now consumed in this country 3,900,000,000 pounds of sugar. The 4,000,000 acres of Florida sugar land would average 4,000 pounds per acre, thus making an annual production of 16,000,000,000 pounds.

In support of what he says, Mr. Jones gives some figures relative to the production of sugar on the plantation of St. Cloud, Fla. It contains 1,000 acres and it averages 4,000 pounds per acre. At this time there is being made on this place 60,000 pounds of sugar every twenty-four hours. It would take a long time to reclaim Florida's sugar lands, but if reclaimed they would, according to Mr. Jones' estimate, produce much more than the entire American consumption at 3 cents a pound, and the profit at that price would be a good one.—*Savannah Morning News.*

Preserve for Binding.

The publishers of the SCIENTIFIC AMERICAN would advise all subscribers to preserve their numbers for binding. One year's issue (52 numbers) contains over 800 pages of illustrations and reading matter. The practical receipts and information contained in the Notes and Queries columns alone make the numbers worth preserving. Persons whose subscriptions have commenced since the beginning of this year can have the back numbers sent them on signifying such wish. Their subscriptions will then expire with the year.

## AN AERIAL VESSEL.

In addition to the lifting power of the balloon, it is designed that this vessel shall be partly upheld by oscillating wings, which are also made to propel the vessel, the wings being operated by the occupants of the vessel. The invention has been patented by Mr. Sigmund Spaeth, of Falls City, Neb. Figs. 2 and 3 are transverse and longitudinal sections, showing the connection of the lower side of the balloon with the car or basket, and the arrangement of the operating levers, the car preferably being formed as a truck sup-

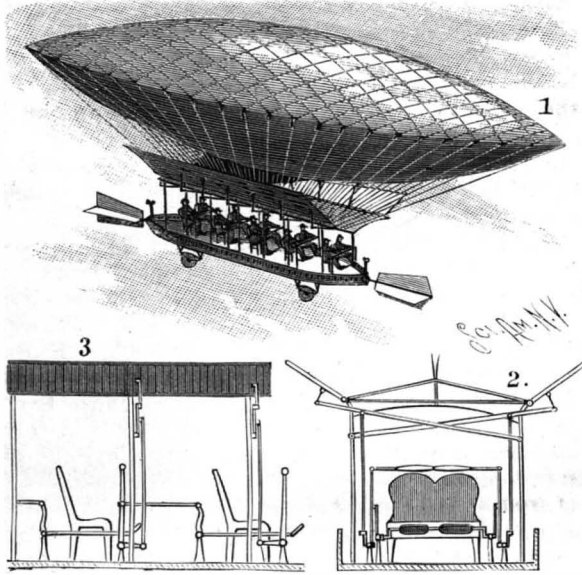

SPAETH'S AIR SHIP.

ported on wheels. In front of each seat are pedals and rocking handle levers, connected by rods with levers fulcrumed on the frame above the seats, the latter levers being connected with the wings. The wings consist of a light framework covered by an airtight fabric, and have openings which are closed by valves on the downward movement of the wings, there being an auxiliary wing having a spring movement pivoted at the rear end of each main wing. At the front and rear ends of the car are steering rudders. As the wings are operated by the movement of the handle levers and pedals by the occupants of the car, the valves open as the wings rise, making the resistance to their upward movement but slight, while on the downward movement the valves close automatically, so that the entire surface of the wings acts upon the air to assist in sustaining and lifting the vessel, the auxiliary wings exerting pressure obliquely upon the air to propel the vessel forward. In starting the vessel it may be propelled along the ground for some distance, on its wheels, before rising in the air.

## MARVELOUSLY LOW-PRICED WATCHES.

The accompanying illustration shows a front view, a back view with the case open, and another representing the works removed from the case, of a remark-



THE "PREMIER" WATCH OF R. H. INGERSOLL &amp; BROTHER.

ably cheap watch which has just been put on the market by Messrs. R. H. Ingersoll & Brother, of No. 65 Cortlandt Street, New York City. It sells for \$1.50, with a handsome and suitable chain, is  $2\frac{1}{2}$  inches in diameter, and weighs  $3\frac{3}{8}$  ounces. It is a stemwinder and setter, American lever, 240 beats to a minute, steel pinions, patent escapement and regulator, and dust-proof case, handsomely finished in nickel or gilt. The watch is fully guaranteed for one year. The factory of this firm produced last year nearly half a million watches, but their new, 1894 style is a smaller and

apparently a better watch. The manufacture is, of course, American throughout, and those who are incredulous as to the possibility of making a serviceable watch at so low a figure cannot fail to be surprised at the success the manufacturers of this watch have attained.

## Bean Oil.

The following particulars of bean oil in Formosa are extracted from a special report on the resources and trade of that island prepared by Mr. Alex. Hosie, late Acting British Consul at Tamsui, and published by the Foreign Office.

*Dolichos Soja.*—More oil is extracted from this bean than from any one of the other oil-yielding plants of China. The two kinds of bean treated for oil are small in size and oval in shape, one having a whitish yellow epidermis and interior, the other being green throughout. They are probably sub-varieties of the *soja* bean. The process of extraction is worthy of description.

The first thing that strikes the eye of a visitor to a bean oil factory is the enormous stone wheel which is used to crush the beans. It is of dressed granite, about 10 feet in diameter and  $2\frac{1}{2}$  feet thick at the axis, gradually contracting to a foot at the rim. This wheel, which is of enormous weight, revolves in a well 30 to 36 inches broad, paved with stone, and bounded on each side by a low wall of concrete some 3 feet high. The massive wooden axle on which the wheel revolves has its opposite end firmly fixed in a huge beam, which rises vertically from the center of the circle formed by the inner wall of the well, and which revolves with the wheel. Behind the wheel, and supported by a plank fixed on and near the opposite end of the axle, is a wooden framework, which just sweeps the floor of the well. The front of the framework has a metal share like a plow, and affixed to the rear is a small square of wood inclined to the inner wall of the well, with a loop of rope or leather nailed to it. The beans to be crushed are heaped in the well against the inner wall. Two mules, blindfolded, are harnessed to the wheel, one in front, the other behind, and walk outside the outer wall. At the first revolution nothing is crushed, but the loop at the end of the framework drags the beans on to the floor of the well, and at the second revolution these are crushed and swept toward the outer wall by the share, making way for a fresh supply of beans dragged on by the loop arrangement at each revolution. The beans are flattened into thin round wafers, and are crushed a second time before they are ready for further manipulation. After the second crushing, bean wafers sufficient to make a cake 4 inches thick and 2 feet in diameter when compressed are put in a square piece of sacking, and placed on a wooden grating above a caldron of boiling water. In a few minutes they are rendered quite soft by the steam which passes up through the grating to the sacking and its contents. During the process of steaming, another workman has been arranging a series of soft straw brooms, which are also steamed, so as to form the bottom of a couple of narrow metal bands surmounted by a wooden casing, over which the long tips of the straw brooms project. Into this the steamed beans are poured and trampled down by foot till the mass is quite hard. The projecting straw tips are then brought over the top of the beans by foot, and trampled down so as to form a covering. The wooden casing is removed, and the metal bands arranged a short distance apart near the top and bottom of the cake respectively. The whole is then put into a primitive wooden press, and subjected to considerable pressure by the driving in of successive wedges. The oil is expressed and drains into an underground tank, the top of which is on a level with the stone-guttered slab on which the lowest cake rests, for half a dozen cakes, one above the other, may be undergoing pressure in the same press at the same time. When all the oil has exuded from the cakes they are taken from the press, the metal bands and straw casings are removed, and, after being left to dry for a time, they are ready to be shipped to other parts of China for manure. The beans yield about 10 per cent weight of oil, and the cakes, when removed from the press, weigh some 64 pounds, and are worth about 2s. 9d. each. They constitute a very valuable manure, and are carefully macerated before being applied to the soil.

To show the commercial value of this industry, I may mention that 60,000 tons of bean cakes were exported from Chefoo during 1890. Nor is Chefoo the principal exporter. Newchwang sent out over 156,000 tons in the same year. In Formosa these beans are grown, and the oil is extracted in the above manner, but only in quantities sufficient to meet local requirements. The refuse cakes are not exported. The oil is used for both cooking and lighting purposes.

THE first Japanese lady physician has recently been licensed to practice in Nagasaki, according to a Dutch journal cited by the *Deutsche Medizinisch-Zeitung*. The lady's name is Marie Saganiana, and she is said to have obtained her medical education in Ohio.

## SUPPLEMENTAL COLORED INK FOUNTAINS FOR PRINTING PRESSES.

The illustration represents supplemental fountains, designed to be placed and used in the ordinary long fountain of any power printing press, to facilitate printing show bills, etc., in colors, in such a way that one color blends with another, where the work is done by one impression. The improvement has been patented by Mr. Otis M. Moore, Seattle, Wash. (box 1513). Fig. 1 shows three of these supplemental fountains placed in a main fountain, Fig. 2 being a sectional

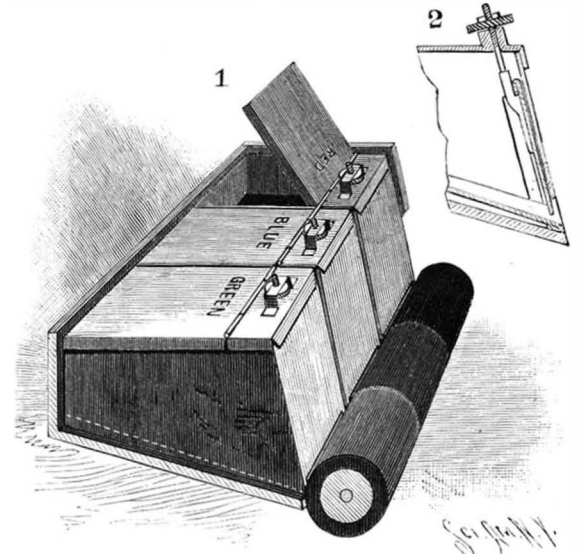

MOORE'S CHROMATIC INK FOUNTAIN.

view of the gate-moving mechanism. The fountain is preferably a sheet metal box with inclined floor, and with bottom flanges highest at the back end, holding it above the floor and ink of the main fountain. Its front portion has a rigid top or cover, to which is hinged an upwardly swinging lid, and at the lower edge in front is a transverse slot extending the full width of the fountain, through which the ink is supplied directly to the roller. In the front corners are angle plates forming a slideway in which moves a gate the full width of the fountain, and by means of which the amount of ink permitted to pass through the slot is regulated. Centrally in the top of the gate is a block, from which a screw extends upward through a suitable bearing and keeper, there being on the screw a milled nut, by turning which the gate is moved up or down to adjust it so that just the right quantity of ink will flow to the roller. Any desired number of these fountains may be used, according to the number of colors the printer may wish to employ on a job, and the fountains are made of varying widths, to facilitate such distribution of the color as may be most effective.

## CORRUGATED PLATE METALLIC LATHING.

The sheet metal lathing shown in the illustration is made with a special form of keys or loops to engage and interlock with the plaster, Fig. 1 representing this lathing as applied and Fig. 2 being a sectional view. The improvement has been patented by Mr. William Eckstein, of Hayward Brothers & Eckstein, No. 187 Union Street, London, S. E., England. It is formed of thin sheet metal, with broad or large corrugations which give a regular undulating surface on

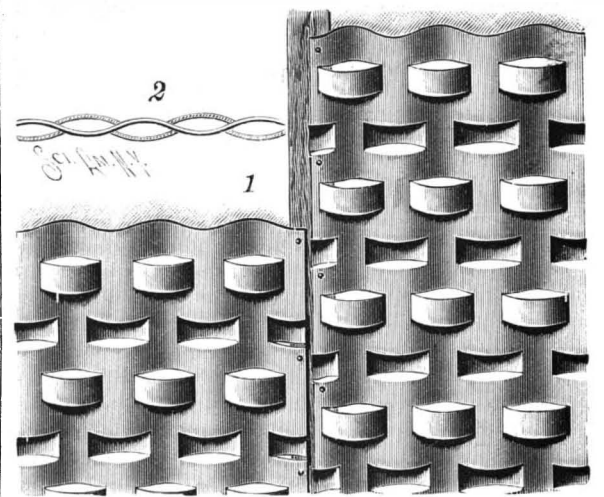

ECKSTEIN'S METALLIC LATHING.

both sides, and in each corrugation are transverse slits, the metal between each pair of slits being bulged to form loops, which bulge the reverse of the corrugation in which they are formed. The ends of one set of loops are not in alignment longitudinally of the corrugation with the ends of the adjacent series of loops, the loops thus "breaking joint," as it were, so that there are no continuous weak lines; but the rigidity of the plate is greatly increased, and sufficiently large openings are provided for the plaster to find its way in proper quantities to afford a firm interlocking engagement with the undulations and the loops.



**A DISTILLING APPARATUS FOR FAMILIES.**

The illustration shows a very simple, comparatively inexpensive, and most efficient form of distilling apparatus, well adapted for use by private families, and in schools, hotels, restaurants, and other places where it is usual to have drinking water always at hand, and where absolutely pure water is a prime necessity. The simple boiling of water, as practiced in many families, or filtering it in even the most perfect way, is by no means certain to destroy all the disease germs, and those which are most dangerous to health may escape separation or destruction by these processes. By distillation, however, absolutely pure water is obtained, and the apparatus shown is of so simple a character that any person capable of boiling an ordinary tea kettle can operate it to distill from two to four gallons per hour. The boiler, A, is of copper, lined with tin. C is a galvanized case or jacket for supporting the boiler over the gas burner, and is detachable at D B, and it is also intended to act as a flue to utilize the heat from the gas burner on the sides of the copper boiler, so as to use all the heat the gas produces on the boiler before it passes out through the perforated ring, J. H is a screw cover, removable for filling or cleaning. F is the connecting pipe from the boiler to the copper condensing coil in condenser tank. G is a union for connecting the boiler and condenser. P is the condensing coil. E is the tank that holds the condensed water and has an inlet for cold water by a slip rubber or other tube at T. I is the outlet for the warm water to escape from the condensing tank by a rubber or other tube. L are the burners, and N is the iron frame that supports the gas burners and also the apparatus. S is the outlet for the condensed water, and X is a glass or other vessel to receive the condensed water ready for use. K are the vent holes, in the ring that rests on the jacket, that allows the exhausted gases to pass off. R is a faucet for drawing off the water from the condensing tank when not required for use. O is a removable cover for cleaning out the condensing tank. M is a gas cock used to regulate the supply of gas to the burners. There is no pressure on any part of the apparatus, as the vapor is condensed as fast as it is made, and the condensed vapor or water passes into the receiver. With all water used for cooking and drinking purposes supplied in this way it is an

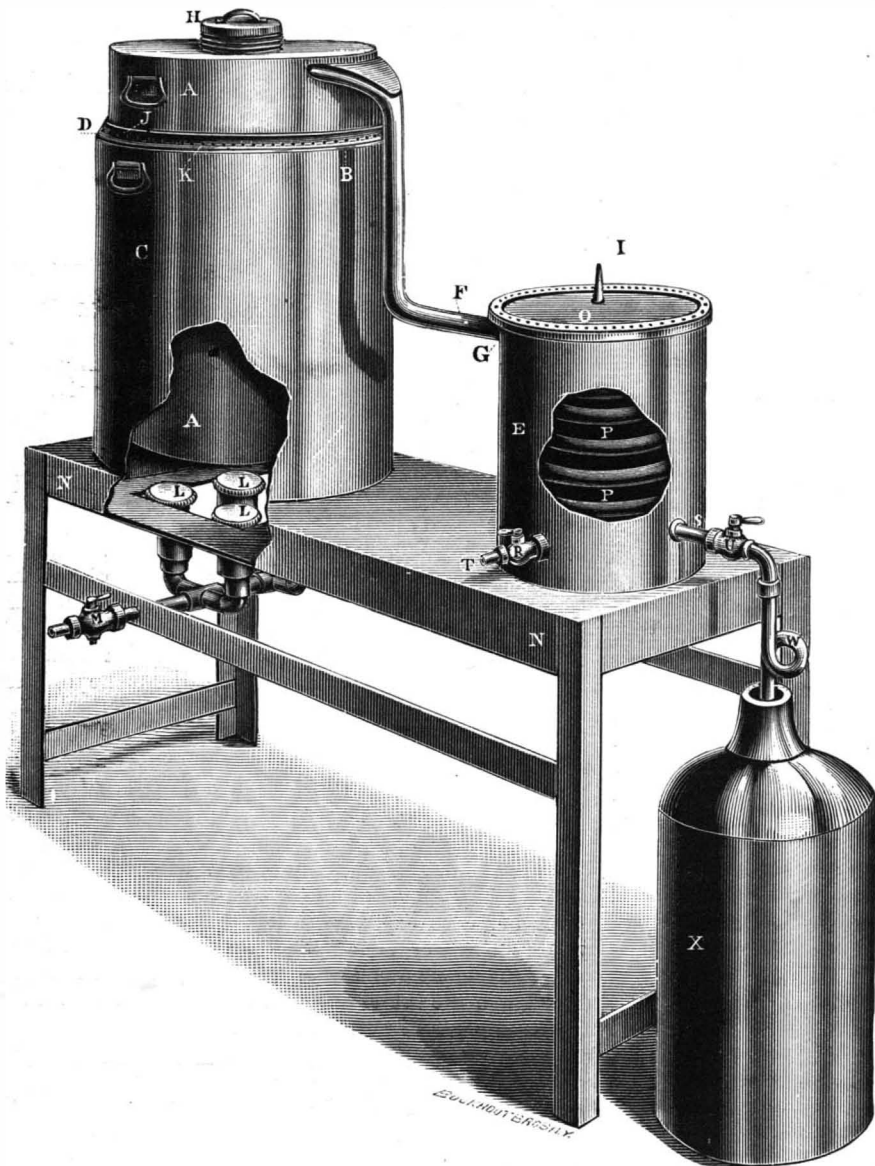

JAMES CURRAN'S WATER DISTILLING APPARATUS.

impossibility that it should contain any disease germs. This apparatus is manufactured by the Jas. Curran Manufacturing Co., manufacturers of steam heating apparatus, New York City, and is on exhibition at No. 397 Fifth Avenue, and at the factory, No. 516 West 36th Street. It has been adopted and is in use by several public institutions, having the indorsement of some of the highest medical authorities.

**AN IMPROVED RELIEF VALVE.**

This valve is more especially designed for use on air pumps of condensing engines, to insure an easy seating of the inlet and outlet valves, and prevent excessive wear of the valves and the lining in the air pumps. The improvement has been patented by Mr. Andrew L. Harrison, of the United States revenue steamer Colfax, Wilmington, N. C. Fig. 1 is a view

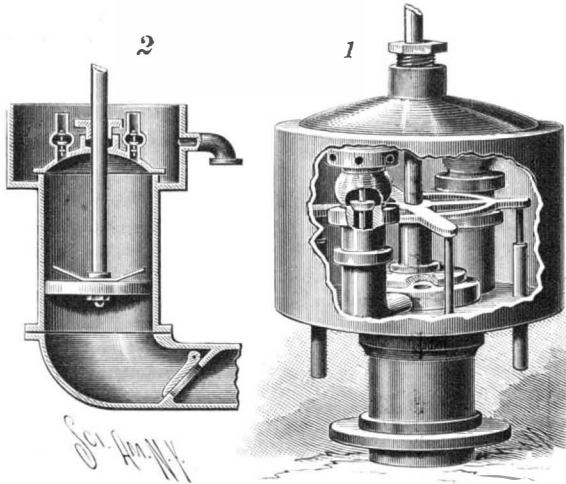

HARRISON'S RELIEF VALVE.

in perspective, partly broken away, showing the improvement applied to the air pump of a propeller engine, and Fig. 2 is a sectional view of its application to the air pump of a condensing engine. At the bottom of the valve casing is an inlet pipe connected with the top of the condenser, the water and air rising in the condenser passing into this inlet according to the action of the plunger of the air pump. The valve seat on the upper end of the inlet has openings closed by a water delivery valve sliding vertically on a hollow stem of the seat, the upward stroke of the valve being limited by a spider. In the bottom of the casing are vertical outlet pipes whose inner ends extend up nearly to the spider, so that the valve always works in the water accumulating in the lower part of the casing, rising only so far as necessary to discharge the water brought up from the condenser by the plunger of the air pump, and seating itself very easily. Into the end of the inlet pipe, where it extends just above the bottom of the casing, open inlets leading to air valves of any approved construction, located within the casing and discharging near its top, the air being discharged from the casing by the vertical outlet pipes through which the water is discharged. As the air enters the inlet on top of the water, it passes out through the side pipes leading to the air valves before the water lifts the central valve from its seat to permit the water to pass into the casing, the valve again closing when the plunger is on its downstroke to prevent the previously lifted water from flowing back, and the water rising in the casing only to the top of the outlet pipes. As shown in Fig. 2, the air outlet valves are arranged directly in the main valve, which is in this case a float top valve, the air being similarly discharged in advance of the water and without unseating the water delivery valve.

**Manganese in Colombia.**

The principal manganese deposits are found about forty-five miles northeast of Colon, going toward the San Blas point, in the Department of Panama. The ore is found in the shape of boulders embedded in clay and distributed along the ore belt. These boulders vary in weight from fractions of a ton to fifty, one hundred, three hundred, and four hundred tons, and sometimes they are associated with jasper. A company composed of Baltimore capitalists has been organized to develop mines, and a railroad from Viento Frio, on the coast, to the Nispero deposits has

already been located and is now in progress of construction. The line is six and a half miles long, with steep grades and sharp curves. There are many other manganese deposits in that neighborhood, but as they are almost completely underground and with very few surface indications, their commercial value has not yet been ascertained; but strong probabilities seem to indicate that thorough prospecting with a steam drill will reveal some valuable ore bodies.

**Carbonic Acid in Air.**

A paper on the value of determinations of the proportion of carbonic acid in air as a measure of the efficiency of ventilation has been contributed to the *Journal of the American Chemical Society* by Mr. E. H. Richards, who states that for the past nine years the Laboratory of Sanitary Chemistry at the Massachusetts Institute of Technology has had exceptional opportunities for investigating this subject, because the Walker building is mechanically ventilated under the direction of an expert, and is fully controlled by the engineer, who has records for all these years of the quantity and temperature of the air supplied to each room, and of the temperature of these rooms taken four times every day. During these nine years, some 5,000 determinations of the carbonic acid have been made in these rooms by 200 students. Many problems arising out of these circumstances have been studied and reported upon; but the net gain of knowledge appears to be meager. The outer air surrounding the institute shows an ordinary proportion of from 3.7 to 4.2 parts of carbonic acid in 10,000 parts of air. The air in the empty rooms shows a rise of carbonic acid of about 0.5 part, due to decomposition of the organic matter present in the flues, the floors, and the walls. The air of the building, in general, of the halls, reading rooms, etc., which are open, and in which people are constantly moving about, is maintained at about 5 parts as an average of all tests for eight years. The air of most of the lecture rooms has contained from 6 to 8 parts; rising to 10 or 12 parts for the large and more crowded rooms, according to the state of the weather outside. From this experience, it would appear that students can work well in a clean room with about 7 parts in 10,000 of carbonic acid. Much more than this causes dullness; and anything over 13 parts is an almost insuperable obstacle to the full acquisition of knowledge by the classes.

**A CURRENT COLLECTOR FOR DYNAMOS.**

This collector takes the current from the commutator cylinder by a rolling contact, thus avoiding the friction and wear due to the use of commutator brushes. The improvement has been patented by Mr. Charles R. Roberts, of Addison, Pa. Fig. 1 represents the collector in position on a dynamo, Fig. 2 being a

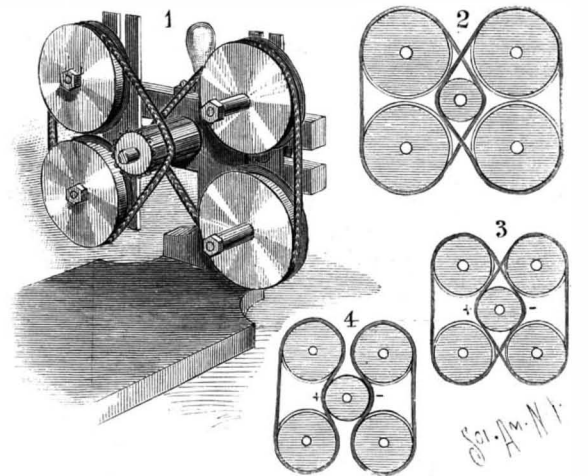

ROBERTS' CURRENT COLLECTOR FOR DYNAMOS.

sectional view, showing the relative proportions of the parts, more particularly for high and ordinary speeds, while in Fig. 3 the parts are better proportioned for low speed. In Figs. 3 and 4 different applications of the chains are shown, the current being positive on the left and negative on the right in Fig. 2, while, as in Fig. 3, the terminals of the field magnets must be changed to generate a current. As will be seen, a pair of sheaves is arranged on either side of the commutator cylinder, and chains passing around these sheaves form electrical contact with the sides of the cylinder, the point of contact between the chains and the cylinder being the same as that of the ordinary commutator brushes. By changing the distance between the sheaves and the commutator cylinder, and also by altering the distance between the sheaves themselves, the amount of surface on the commutator cylinder covered by the chains may be readily varied. With this improvement the commutator keeps cool and does not require oiling. It may be applied to most machines now in use, being run equally well either backward or forward, and is very inexpensive.

## HOW TO MAKE A TELEPHONE CALL.

(Continued from first page.)

the side of the loop and bearing against the pole piece. The convex side of the casting, *u*, is provided with a rectangular notch, *a'*, for receiving the L-shaped permanent magnet, *b'*, which is held in its place by a screw passing through the magnet into the casting. To the L-shaped magnet, *b'*, is secured a plate, *c*, which is bent twice at right angles, and in the bent ends of which are inserted pivot screws supporting the armature, *d*, which extends downward between the adjacent ends of the pole pieces, *w w'*. The armature is covered by a strip, *e'*, of copper, and in the end of the armature is inserted a wire, *f*, carrying at its extremity a bell hammer, *g'*. To the outer surface of the door, and on opposite sides of the bell hammer, are supported two bells, *l*, by studs, *i'*, projecting from adjustable plates, *j'*, pivoted to the door at one end and provided with a curved slot at the opposite end for receiving a clamping screw, which passes through the slot and into the door. By means of this device the bells may be adjusted so that each will receive a stroke of the same power from the bell hammer, *g'*.

The spools on the pole pieces, *w w'*, contain about 1½ ounces of No. 34 silk-covered copper wire. They are wound in the same direction, and the inside ends are connected together. The outer end of one spool is connected with the upper hinge of the casing, which, in turn, is connected with the binding post, *q'*; the outer end of the remaining spool is connected with a strip, *k'*, of copper attached to the door and connected with a plate, *l'*, which comes into contact with the spring, *t*, when the door of the casing is closed.

On the top of the casing there is a plug switch, which also answers as a lightning arrester. The rear plate of the switch is provided with the binding post, *m*, which is connected with the ground. The binding posts, *q q'*, receive the ends of the line wire, the connections being made as shown in the article on the telephone in SCIENTIFIC AMERICAN, No. 5, current volume (February 3).

When the call is placed at the end of the line the call box is grounded by inserting the plug, *r*, between the rear or ground plate and the front plate that is not connected with a line wire. When it is desired to cut the call box out of the line, the plug is inserted in the circular space between the two front plates, the current passing from one end of the line through one of the binding posts and plate to the plug, the other plate and binding post to the other portion of the line. When the armature, *B*, is turned by revolving the crank, *G*, opposite ends are alternately presented to opposite poles, the consequence being that the rapid changes of magnetism in the winding of the armature which operate the polarized bell of the instrument, also the polarized bell of the distant instrument, both being normally in the circuit.

While talking over the line it is important to cut out the magnet on account of its resistance, and while signaling over long distances the signals are more effective if the telephones are cut out of the line.

These machines can be purchased for \$4, and we therefore doubt if it is profitable to undertake to make them; however, they may be made without fear of legal complications, as they are not patented.

## Experiments on Schnebelite.

Some very interesting experiments on the remarkable explosive "schnebelite" were recently made at Argenteuil, France. The brothers Schnebelin, one a priest and the other a lieutenant in the French artillery, are the inventors. The chief ingredient of schnebelite is potassium chlorate, the dangerous properties of which have been modified so that a powerful and safe explosive has been obtained. The new powder is made in three forms—for military rifles, for sporting guns, and for mining purposes. At the recent tests at Argenteuil the Abbe Schnebelin prepared his explosive in the presence of a number of spectators, and afterward ground the powder in a coffee mill and struck it with a hammer without exploding it. Heat ignites the powder only at 540° Fahrenheit. The explosive gives off little smoke, though it hardly compares with the so-called smokeless powders in this respect. The test in the quarries near Argenteuil showed that the explosive is especially good for blasting, as the impact of the drill will not set off an unexploded charge remaining in the drill hole.

## A New Silkworm.

According to a report of the French consulate in Trieste, *Bombyx tasiocampa otus*. The moth is similar to that of the silkworm, but the cocoon is much larger, and the silk finer and snow white. The worm feeds on the leaves of the evergreen *Quercus ilex*. Experiments are being made with the intent of raising this newly discovered worm for commercial purposes.

## Staining Leather.

This is essentially a process of painting of the leather by means of colored liquors which are brushed on by suitable brushes. The apparatus required for this purpose is quite different from that used in the dipping method. The principal feature is the tables. These are made with a perfectly flat and smooth top, and should be of some hard wood—beech, birch, or teak, or, better still, of wood covered over with a sheet of lead, which need not be very thick, but no wood containing tannin. The size of the tops should be proportioned to the size of the skins which are to be treated. Thus for kid and lamb skins, the size may be 4 feet by 3 feet, for sheep skins about 5 feet by 3½ feet, and for larger skins in proportion. Several different sized tables must be provided, suited to the variety of skins which are to be stained. It will conduce much to the convenience of the workmen if the tops are provided with a rim round their edge standing up from 1½ to 2 inches, having draining holes at two opposite corners, so that any surplus liquors may run into suitable receptacles placed underneath, or into the drains. The principal requirement in such tables is smoothness of the top. This should be absolutely free from any cracks or indentations which might catch and scratch or tear the skins while working.

On the right hand corner or edge of the table, a shelf may be fixed to hold the various vessels containing the dye liquors. These may take the form of earthenware mugs, and should not be too large, so that they may have to be frequently refilled from the main stock of dye liquor, a method which assists in getting uniform colors. Below this end of the table may be placed a tub of dye liquor, which may be large enough to contain enough for a day's supply. This may be heated by steam pipes if the use of hot liquors be neces-

for the purpose. For two reasons, the natural vegetable colors are rarely used. In the first place it is obvious that solubility in water is absolutely necessary, and the coal tar colors, with few exceptions, possess this property in a great degree, while the vegetable colors, as a rule, do not. The second reason is that the coal tar colors are self-colors, and do not require any mordant; and on the other hand the vegetable colors, with few exceptions, require a mordant to develop any color from them. The coal tar colors alone, therefore, will be treated of in these articles.

The basic colors, such as magenta, Bismarck brown, phosphine, etc., are those which give the best results with this method of working, and this is due to the fact that they have naturally a strong affinity for the fiber, so that no preparation of the leather is required. The acid colors also work well, but to obtain fast colors and the best effects they require the aid of a little acid as a kind of mordant. These colors are sold in the form of the alkali salts of sundry color acids, and as it is necessary that this color acid and the leather should enter into mutual combination, the color acid must be liberated from its combination with the alkali before it will form the new compound with the leather. This is effected by the addition of a stronger acid—sulphuric, acetic, etc.—to the dye liquor, or the leather may be prepared by treatment with a little acid liquor. Weak solutions of the dyestuffs should be used, say 1 to 1½ ounces to a gallon of water, and if this does not give a deep enough color, it is better to go over the skins several times than to aim at getting the full depth of shade at one operation.

The method of working is comparatively simple. The skins are laid on the table, and by means of the brushes the dye solution is brushed over the surface. The sweep of the brush may be made either in straight lines or in circles, which is, perhaps, the best way, the main idea being to cover as much surface as possible in one sweep, as thereby more even results are obtained. Too much color should not be taken by the brush at one time, only just enough to saturate the bristles. Speed of brushing is a very important element in obtaining even shades; when the work is done slowly there is time for one part to get dry before another is touched, and this is avoided by taking quick sweeps with the brush. When one coating has been given, the skin is hung over the horse to dry, and another is treated. When the whole batch of skins are done, the first is then examined to see if the right depth of color has been obtained, in which case it is transferred to the drying room to become thoroughly dry. If another brushing is necessary, this is repeated as before, until the correct depth of color has been reached, before the skin is sent to the drying room.

In the event of using azo and acid colors, which, as noted above, require some acid, this may be added to the dye bath, or the leather may have previously received a brushing with a little weak acid liquor, or

again, after the color has been brushed over a brushing of acid liquor may be given. Probably the best method of working is a combination of these plans; the leather is brushed over with a solution of 1 pound of sulphuric or 3 pounds of acetic acid in 10 gallons of water, then with the dyestuff solution, then with the acid again, these operations being repeated until the proper depth of color has been obtained. These acid and azo colors will stain the leather without the aid of an acid, but the latter has a very material influence on the brightness of the shade or tint.

It may be mentioned that machines have been devised to stain the leather, and so do away with brushing. One such apparatus consists essentially of a table of a circular form made with a rim; on this the skin is stretched.

From a horizontal arm, placed a short distance above the table—made of tubing in which are a series of holes—dye liquor is poured on to the skin while the latter is made to revolve along with the table. The surplus liquor runs off through holes in the edge of the table, and can be used over and over again.—*Dyer and Calico Printer.*

## Gunpowder and Explosives.

The London *Daily Telegraph* thinks that the days of gunpowder as a charge for naval guns are numbered, as some experiments just concluded at the government proof-butts, Woolwich, appear to prove a decided superiority for cordite. A 6-inch quick-firing gun was loaded with 29 pounds 12 ounces of the ordinary black gunpowder, and yielded a velocity of 1,890 feet per second, with a pressure strain on the gun of 15 tons per square inch. The same gun was charged with 14 pounds 3 ounces of cordite, and gave a velocity of 2,274 feet per second and a pressure of 15.2 tons. More important still, after 250 rounds had been fired, there were no signs of erosion.

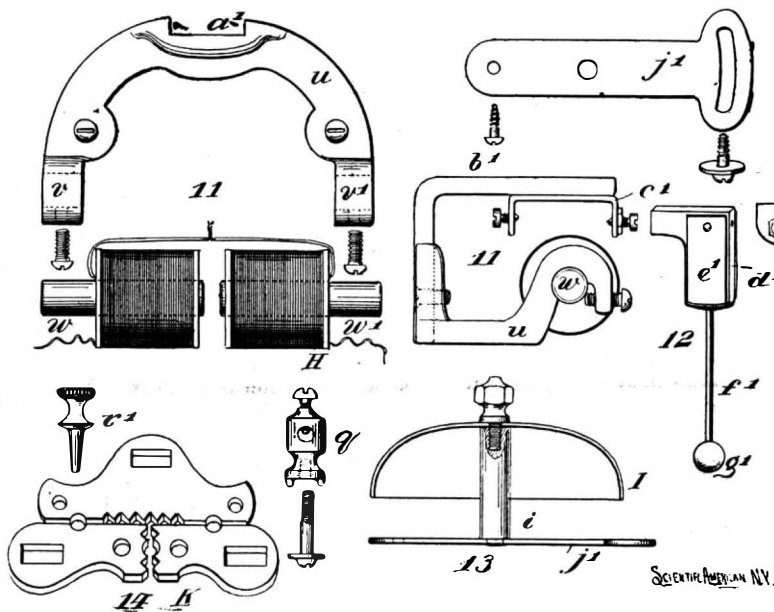

11. Bell Magnet. 12. Armature. 13. Bell. 14. Lightning Arrester and Cut-out.  
DETAILS OF MAGNETO CALL—THE BELL.

sary, and from it the smaller mugs are replenished. Into this tub may be run the surplus dye liquor from the table, so that there is not too much waste of material.

At a convenient place, handy to be reached by the worker, should be a water tap fitted with a flexible hose-pipe, so that with it the skin can be well rinsed after dyeing, if such a proceeding be necessary. If it is not convenient to fit up a waterpipe, the dyer ought to have a tub of clean water beside him, and this tub should be used by him alone. It is not desirable that other dyers should have the use of it, as in this case there will be a risk of off shades being produced. Near by is a horse or rail, on which the skins, after being colored, are hung to drain before being taken to the drying room.

As to the brushes, several will be required. These should be made of soft fiber, about 6 by 2 or 2½ inches in size, and of as convenient form for handling as possible. Those made for brushing shoes or grates will be found serviceable as, being of fair size, a good extent of surface can be covered at one sweep of the brush, and this means greater evenness of color in the finished skin. The number of brushes which will be required will vary according to the character of the work, and no rule can be laid down here on this point. It is important, however, that a brush be kept for each particular mordant and dye, so that there is no risk run of getting new colors or liquors contaminated by the remains of old colors, or of mordants which may be left in old brushes. However well these may be washed, it is scarcely possible to remove every trace of old color or mordant from them, which, getting into a new liquor, might spoil it, and this is more likely to occur with light colored liquors than with dark ones. Skin coloring is a very delicate matter, especially with kid leathers.

The coal tar colors lend themselves admirably to this method of coloring leather and are mostly used



## Correspondence.

## Natural Grafts.

To the Editor of the Scientific American:

On reading the article in the SCIENTIFIC AMERICAN of February 10, on the "Forestry Exhibit at the Columbian Exposition," I am reminded that there is a similar case of what I suppose to be "natural graft" still standing green and growing near my native place, Mt. Vernon, Ohio.

Two white oaks, now large trees, have grown together and have been in this condition as far back as the memory of the oldest inhabitant can reach. They stand at the ground, as I recollect them, about fifteen or twenty feet apart, and at about thirty feet above the ground have grown together completely, very much as in your Fig. 1, the combined tree above being about twice the size of either below, showing that the union is complete. They stand upon a hill top, near the road side, a conspicuous object, quite alone, as though the woodman's ax, which has slaughtered so murderously our Western forests, had felt, or fancied, the sacredness of some such command as, "What God has joined together let not man put asunder."

W. T. COLVILLE.

Carbondale, Pa., February 9, 1894.

## Winter Fishing on Lake Erie.

BY EDWARD HALE BRUSH.

Fishing in the waters of Lake Erie is carried on in both winter and summer. It is an industry upon which thousands of families living upon both the American and Canadian shores of the lake are to some extent dependent. When the season of navigation closes, and freight and passenger steamers and sailing craft are no longer seen upon the bosom of this beautiful inland sea, there comes a time when, for a while, quiet reigns over the surface of the lake, and human life is a stranger to it. But as soon as the cold of winter congeals the waters, and the ice formed becomes thick enough to go upon, which usually happens early in the winter, a change comes over the lake again.

When the winter fishing season is at its height, so to speak, and on days when no fog is on the lake and it is not extremely cold, there are hundreds and even thousands of men and boys upon the lake engaged in fishing through the ice. The scenes presented by the groups which dot the frozen sea for many miles of its extent are always interesting and often picturesque. The men, muffled up to their eyes for protection against the intense cold and piercing wind, the dogs and the sleds and the bleak stretch of the icy plain for miles in every direction, give one the impression that he is in some frozen country of the far North.

The fisherman who would make the most of his opportunities must bestir himself at an early hour. If the morning is clear, usually the hardy men may be seen getting ready for the start out upon the ice about five or six o'clock. Sometimes, however, they make the start as early as four o'clock. They dress themselves in rubber boots that come up high on their limbs, and in headgear that comes down around the ears and neck, and leaves only the eyes and nose and mouth exposed to the sharp wind. Sometimes a man who has had his feet frozen will take the precaution to wear padded shoes of duck, to prevent their being frosted again. These make his feet appear twice their usual size, and the fisherman looks more than ever as if fitted out for an expedition to the North Pole. Thus attired, the men and boys place the baskets containing the tackle, and which will serve also to hold the fish, upon the sleds and start off upon their cold journey.

The sleds are provided with handles or pushers projecting from the rear, by which they are shoved along upon the ice. Sometimes dogs are harnessed to the sleds. Most fishermen have their dogs, and they would as soon think of parting with them as with their wives and children. Formerly dogs were more generally used than now. As the fisherman trudges along over the frozen lake, now jumping a crack, now steering out for an air-hole, he chews his tobacco vigorously, laments the luck of the day before or brags about it, as may be, and, all in all, is not a discontented man by any means, though his work is so full of hardship. Usually a trail across the field of ice is followed. This is marked by flags which the men put up at intervals of a few hundred feet. These tell them where the ice is safest, and also prove useful in case of fog in guiding the men to shore.

The fishermen do not stop until they get well out upon the lake. An amateur fisherman would not know where to go to strike the good fishing grounds, but with those who live by what they get out of the lake, it becomes second nature to know where the fish are. As a rule, the best fishing ground is where the water is deepest. The greater the depth, the warmer the water will be at the bottom. The fish seek the warm spots, just as animals who live on shore generally do. There is not much to be caught near shore. The depth of the water where the most fish are caught is from forty to sixty feet.

The first thing the angler through the ice does when

he reaches the spot on the ice where he is to halt for the day is to set up his "wind-break." This is a sheet of canvas attached to poles which are set up vertically in the ice. When the fisherman gets under the lee of his wind-break he may not be as warm as though he were in front of a toasting fire, but he is much better off than if he got the full force of the breeze which comes sweeping over the frozen plain, and the snow storm which often accompanies it. Much of the time the middle of the lake presents the appearance of a continuous snow squall. It may not be snowing at all on shore, but out upon the ice the wind, which blows a miniature hurricane a large portion of the time, carries the loose-lying snow with it, and often the storm is so blinding that one can see but a short distance ahead.

When the wind-breaks are up, each man takes an iron chisel and digs from three to five holes in the ice, about five or six inches square, through which to fish. For fishing through the ice the angler uses what he calls a "tip-up." It is made of two sticks joined together in the form of a cross. The line is attached to the head of the cross, and the latter is laid flat upon the ice, so that the head comes directly over the hole that has been made. When there is a bite, the head of the tip-up is drawn down and the other end flies up, and the arms prevent its going through the hole into the lake. To each line is attached a sinker, from which are suspended by a wire two hooks. Thus each fisherman tends from three to five lines and from six to ten hooks, and when the fish bite well it is all he wants to do to keep track of the series. To prevent the holes from freezing up he has to keep baling out with a ladle the ice which forms.

The fish most often caught through the ice are herring, perch, and yellow pike. Now and then a sturgeon will be hooked. Minnows are used for bait, and care must be taken always to have fresh bait, for the fish do not like stale food any more than men do. Often it is bitter cold work taking the fish. The water almost freezes on the hands, the garments of the anglers become stiff with snow and ice, and their beards become icicles depending from their chins. But usually the well-toughened men do not mind it if the fish bite well. Now and then, however, the cold becomes so intense that it drives the men ashore, for at such times they know too well that there is danger lest they may freeze to death. Such a fate sometimes overtakes the unwary.

What provokes the fishermen more than the cold is to have the bait taken from the hooks. This is done a great deal by the lizards—"lisses," the fisherman calls them. The black lizard is a little animal from four to six inches in length, and the fishermen are not particularly fond of him as a rule, for the reason that he is good for nothing for food—though the Indians used to eat him—and causes them so much annoyance.

The most exciting event of the day often comes when the morning's hard toil is over. By noon, or early afternoon, the men are usually ready to leave for shore. Gathering up their implements, after setting the lines for the night, and tying the baskets containing the fish securely to the sleds, they start off, pushing the sleds before them; or, if they have dogs, they call them, and the faithful animals obediently assume the harness by which they are to pull the morning's catch ashore. Oftentimes the fisherman gets on the sled, too, and allows his dogs to pull him as well as the fish. The wind-breaks are shipped from their moorings in the ice, and if the wind chances to be in the right direction, sailing rigs are made of them for the sleds. Then the dogs, instead of pulling the loads, run behind and try to keep up with them, or perhaps they are taken on the sleds. If the wind is stiff, the ride over the ice is made at almost the speed of a railroad train. The excitement is intense, and makes the rider almost forget the terribly cold air and the danger lest at any second some ice-jam will throw the sled over, and its occupants will go scudding along into an air-hole or a crack in the ice. It takes but a few minutes of this kind of traveling to cover the distance which perhaps it required an hour or more to walk in the morning.

If one looks around when the fishermen are making their preparations to leave the fishing ground, he will almost always see a flock of gulls hovering somewhere near. These birds are very intelligent about understanding the movements of the fishermen. They know as well as the men themselves do when everything is ready for the homeward start. The signal for departure is the signal to the birds to come to supper, and they are unailing in their readiness to obey it. Scarcely will the fishermen have started on their homeward trip before the gulls will have swooped down on the ice where the men have lately been; and then a struggle begins over the remains of stale minnows, small fish, and lizards which the fishermen may have left. Often there will be enough of the refuse to afford a respectable meal for the birds. Sometimes the fishermen will purposely leave but little for them. Sometimes, too, they play tricks on them. They will leave a hook in one of the lizards and fasten the line to something upon the ice. Then some bird is likely to be caught; but often the gulls are smart enough to eat all the liz-

ards but the one containing the hook and leave that one.

The fish, after being caught and taken from the water, freeze stiff in a remarkably short time. In this condition they are packed and shipped to New York and other points. The frozen fish make a pretty sight as they lie dumped together in piles on the shore. But it is their market value rather than their beauty which appeals to the fisherman, and there are few better satisfied men in the world than he when he can sell for six cents a pound a big morning's catch of from one hundred to one hundred and fifty pounds. It is only on lucky days that he makes a catch of this size. Fifty or sixty pounds of fish is counted a good average morning's catch.

Now and then a fog comes over the lake. Sometimes it remains for several days. When the fisherman rises at daybreak and, peering out of his cottage window, finds the lake hidden by a white mist, he goes back to his warm bed, for he knows that there will be no fishing for him that morning. There is nothing of which a fisherman is so much afraid in the winter as a fog. If he gets lost in it out on the ice without a compass, he may wander for days without reaching land, if he does not freeze to death; or he may run upon thin ice or into air-holes, for the fog is often so thick over the surface of the lake that it is impossible to see for even a short distance ahead. There is a terrible possibility that is calculated to make the fisherman shudder with apprehension in case he gets caught out in a fog. It is that he may wander off upon the edge of the ice and perhaps get upon a piece which will separate from the main mass, and, carried along by the resistless current of the Niagara River, take him, still hidden in the impenetrable fog, far down the mighty stream, and, perchance, to the brink of the awful falls themselves, before breaking into fragments and plunging him into the icy waters of the rushing river.—*The Outlook*.

## The Salton Sea.

The climatic changes which will result from the lake so recently formed in the deserts of Southern California have been the subject of much popular discussion, and correspondents have given full play to a lively imagination in their surmises regarding the changes which are imminent. It is a fact that on the coast adjacent to this lake there has been an unusual, and, according to the oldest inhabitant, an unprecedented rainfall; but whether this is merely a coincidence or the direct result is not easy to determine. Our knowledge of summer storms, and ability to predict them, is not an exact science. It is well known that the showers occasionally falling in summer are not connected with general cyclonic disturbances, but are due rather to local causes. Lieutenant Finley seems to attribute but little influence to the lake so recently formed, and regards the heavy rainfall in the country adjacent as mere coincidences, nor does he believe that there will be any climatic change, even should there be formed a permanent inland sea, basing his opinion on the fact that in many portions of California, Nevada, and Oregon, in regions equally arid, there are lakes of large extent, and that they do not materially modify or differ from the climates prevailing elsewhere. When it is remembered, however, that this lake covers some 1,700 square miles, and that at a moderate calculation from each square mile some fifty millions of inches of water are daily absorbed, there must be an increase of aqueous vapor in the surrounding air, and if the circumstances were such as to be favorable to condensation, a greater precipitation could easily result. It is claimed that the topographical features of the country strongly favor such condensation, there being in close proximity an elevated mountain chain, beyond which the cool breezes from the ocean render the air along the western slope decidedly colder. It is in these mountains that the recent cloudbursts occurred. There has been a series of storms, and so far, no more plausible explanation of such precipitation has been offered.

It would seem that this region would be a far better field for the experiments now being conducted by the government in its effort to produce artificial precipitation than the places so far selected. Granting that the hypothesis on which these experiments are being conducted is true, in order for them to succeed there should be a large amount of aqueous vapor in the air. Certainly the conditions surrounding Salton Lake in this respect would be extremely favorable for such experimentation.—*Occidental Medical Times*.

THE Folsom Telegraph learns that the big log chute which has been under course of construction by the American River Land and Lumber Company during the past year is nearing completion rapidly. The chute is 3,000 feet long, and the top of the same is 1,200 feet higher than it is at the bottom. Logs 30 inches thick are used in its construction. There are seven of them—one used forming the bottom and three on each side, making a V-shaped flume of it. Among the cribbing that has been built is one place over Slab Creek, 200 feet long and 50 feet high. This is built up of solid logs, placed one on top of the other.



**THE WEBB ACADEMY AND HOME FOR SHIP BUILDERS.**

Years ago the American ship builders of the coast cities, Bath, Newburyport, Boston, Brooklyn, New York and others, were a numerous race of skilled mechanics. In the city processions of former days there was no finer body of men than those who marched in the ranks of the ship carpenters, each

man carrying his broadax, the characteristic tool of a characteristic trade. To-day this is a thing of the past, and old time shipping men remember with sorrow the times when South Street, New York, daily heard the sounds of caulkers' mallets, and at frequent intervals the more musical driving in of the wedges for the launch of a ship.

Mr. W. H. Webb, the son of a ship builder, and

himself one of the leading builders of America, is the founder of the "Webb Academy and Home for Ship Builders." It is situated on the banks of the Harlem River, at Fordham Heights, in this city, occupying one of the finest sites within the metropolitan limits. Here some thirteen acres of ground were purchased, and the double towered building of brick and stone which our illustrations show was erected.



ONE OF THE DRAWING ROOMS.

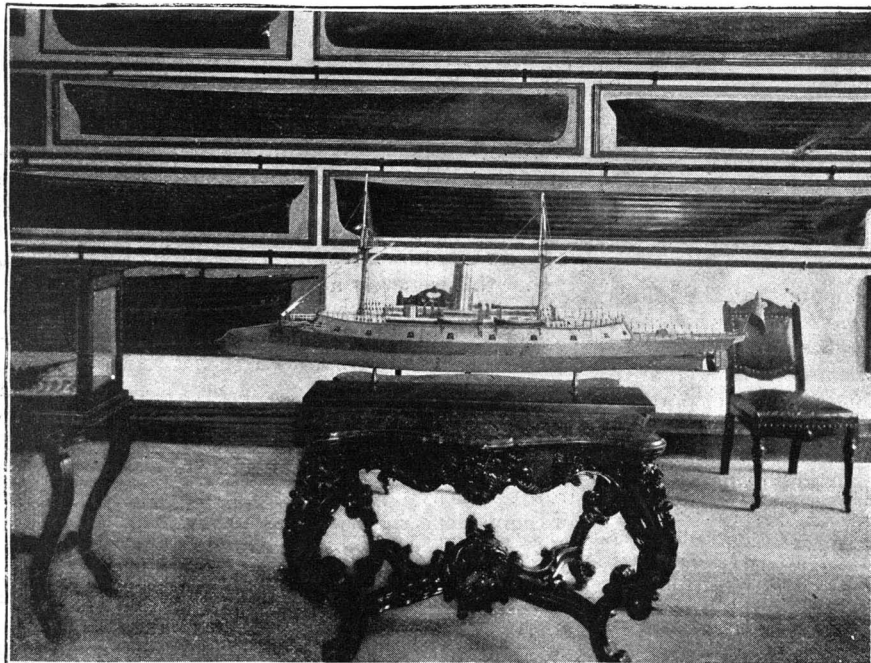

THE MUSEUM—SHOWING THE DUNDERBERG'S MODEL.



WEST FRONT OF BUILDING.

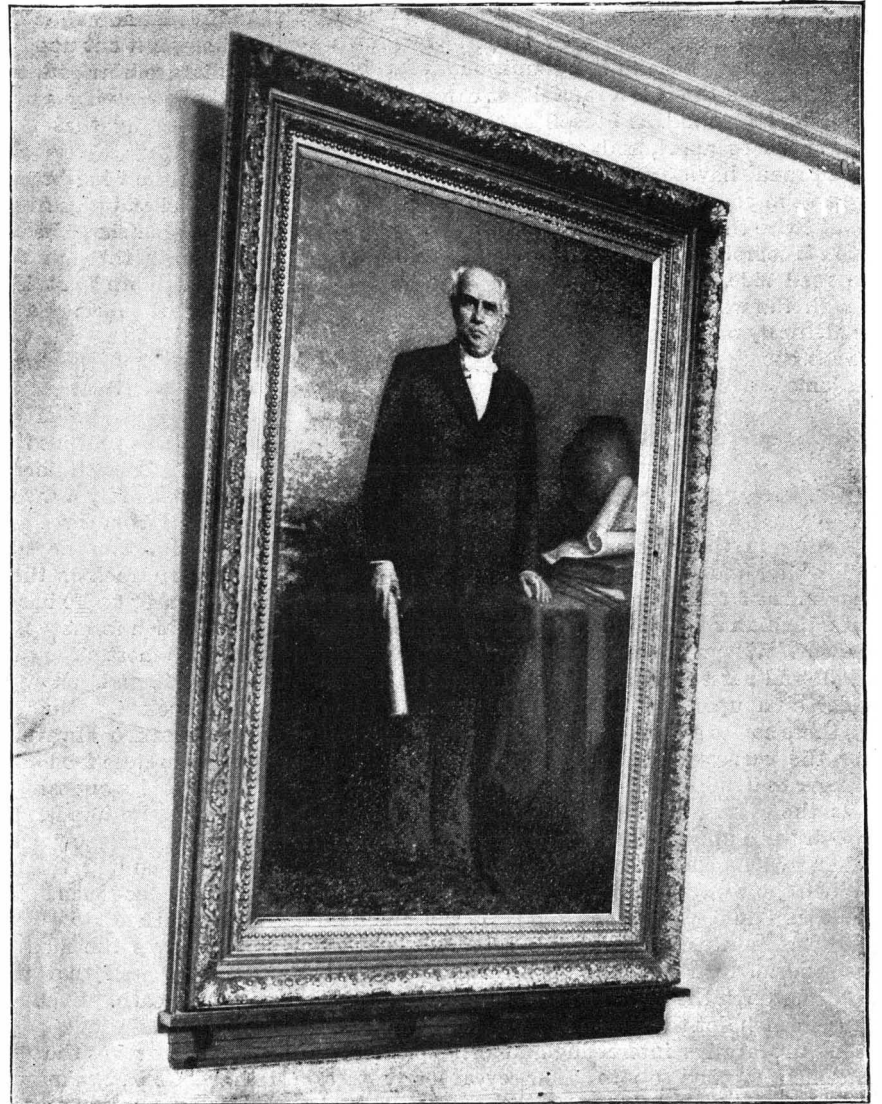

PORTRAIT OF THE FOUNDER.

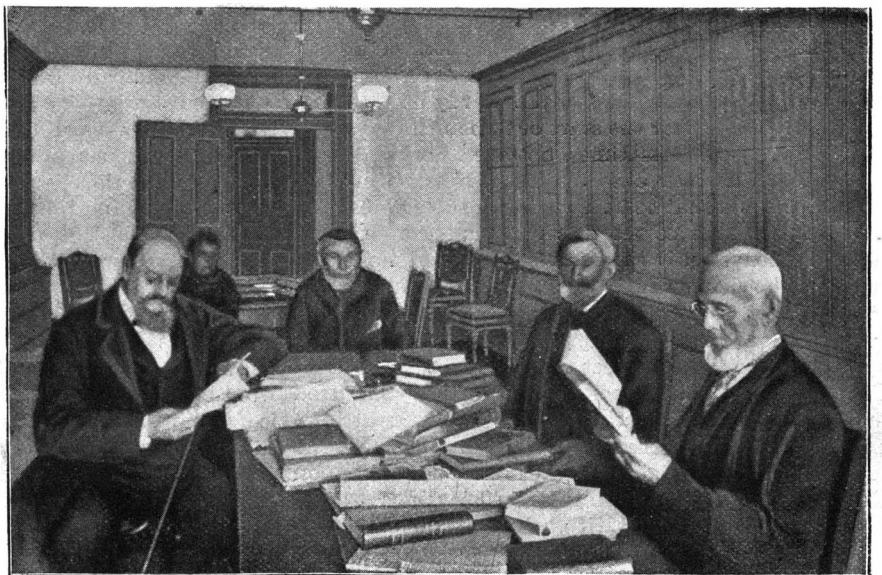

THE LIBRARY.

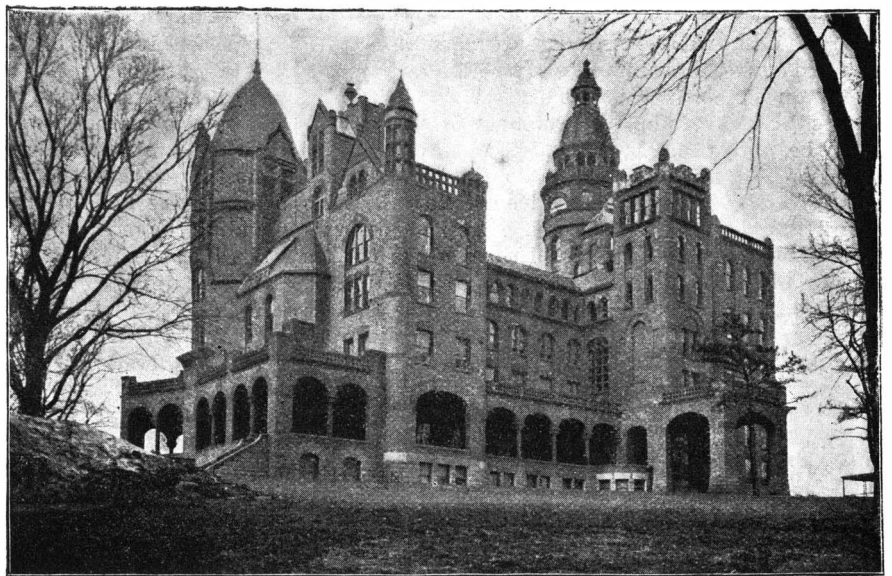

SOUTHEAST ASPECT WITH CORRIDOR.

**THE WEBB ACADEMY AND HOME FOR SHIP BUILDERS.**



It includes two departments. One is the home for aged ship and marine engine builders. To this are admitted destitute ship carpenters and their wives, under the restriction that they shall have been of that trade. It has been calculated that over seventy trades may be represented in the construction of a ship; the Webb Home is for wielders of the broadax only and for the engine builders. These inmates of the home are termed the guests. At present all the guests have been in the employ in times past of Mr. Webb or of his father.

The other department is the Academy of Ship Building. This is for boys whose parents are unable to continue their education in ship building. The candidates must be between 17 and 20 years of age and must pass a satisfactory examination, the mathematical part being particularly insisted on. The academy furnishes to such boys a free and gratuitous education in ship building and marine engine building, with board, lodging and necessary implements and materials.

The institution is incorporated under an act of incorporation passed by the New York State Legislature and approved by the Governor April 2, 1889.

The building is one hundred and eighty feet long and

of a hotel. The guest's and boys' rooms are practically identical in their furnishing.

Two power elevators and a complete electric lighting plant are part of the equipment. Both gas and electric lighting are supplied throughout.

In the second story hall hangs Mr. Webb's portrait in full length, by G. Gerhard, which we reproduce.

The school rooms occupy part of the north tower. The boys' preferences so far have been for ship building proper. Many of the rooms are fitted up with drawing tables and improved drawing boards. The marine engine building course will, undoubtedly, soon be a feature. Prof. Constantine Janssen is in charge of the course at present, and instructors will be added as required.

One of the characteristic features is the moulding loft, occupying the extreme upper story of the main building. Here the students will have practice in laying out the lines of ships of the full size, reproducing their work from model and draught exactly as in regular ship-yard practice.

The museum contains a number of models of ships built by Mr. Webb and some most interesting pictures

#### THE FOUR-MASTED SHIP AFGHANISTAN.

It is not an easy matter to obtain a photograph of a large ship under full sail. It is only upon the broad ocean that her full canvas is ordinarily brought into play. It was at the beginning of a voyage from the outer harbor of Boston that our artist correspondent, Mr. H. L. Stebbins, happily succeeded in camerizing the four-masted ship *Afghanistan*, and from his photograph our engraving has been made.

The *Afghanistan* is a British ship, built in 1888, of iron, at Stockton on Tees, by Richardson, Duck & Co. Her gross register is 2,286 tons. Length, 291 feet 2 inches. Beam, 42 feet 1 inch. Depth of hold, 24 feet 3 inches. She is provided with steam hoisting apparatus and all the modern improvements. At present the ship is in Chinese waters.

#### American Trade in Ecuador.

United States Consul Dillard, of Guayaquil, says: The advisable course to pursue in order to foster a trade with these countries (Guayaquil being the commercial metropolis for a vast extent of territory) would be to send hither competent men who speak Spanish to

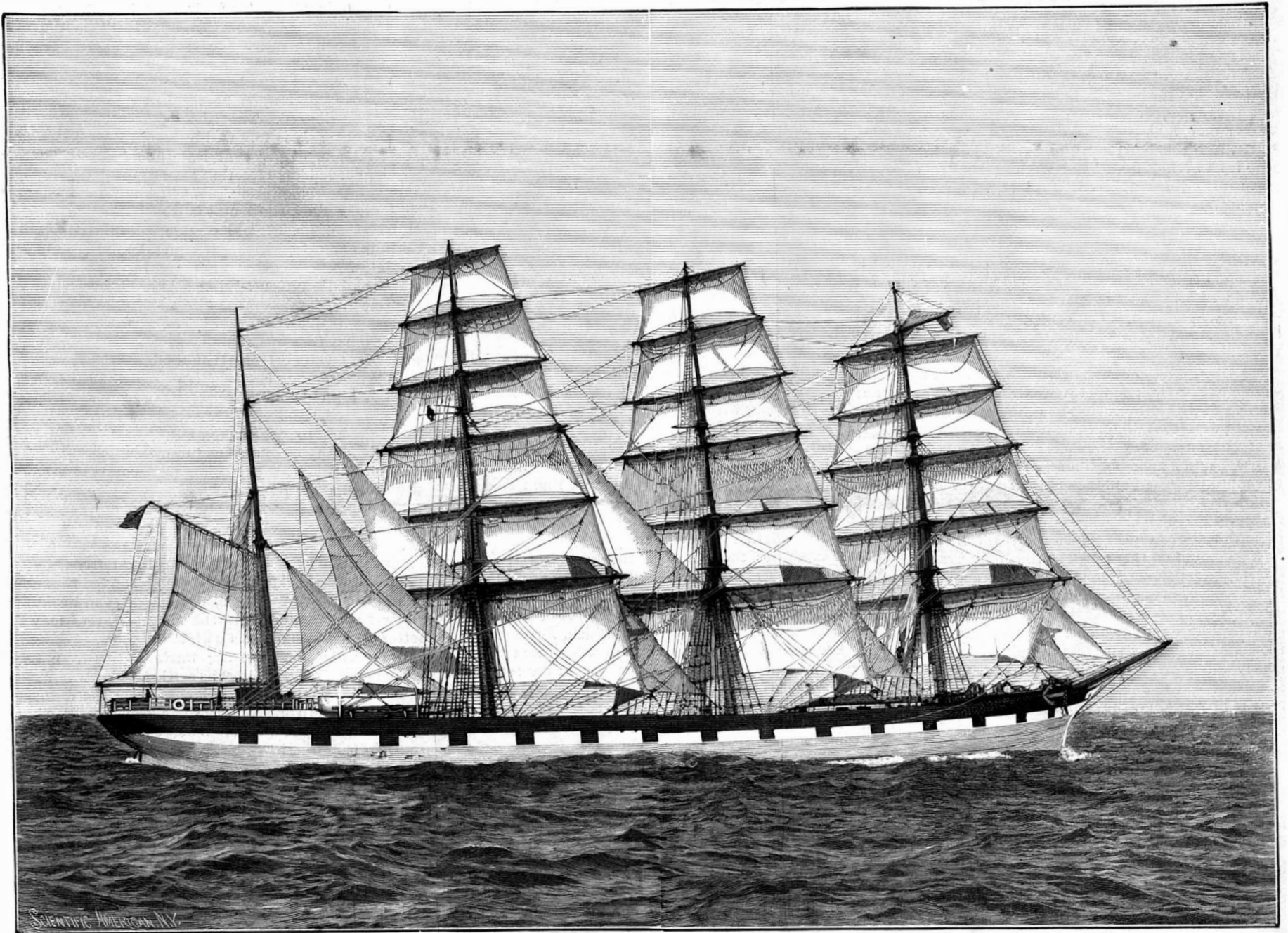

THE FOUR-MASTED SHIP AFGHANISTAN.

eighty feet deep. It faces to the east, its rear windows overlooking the Harlem River. Its lower tower is surmounted by a flagstaff bearing as weather vane a model of the armored ship of war *Dunderberg*, commenced by Mr. Webb for the United States navy during the war, and subsequently sold by him to the French government. A piazza, with columns of brownstone and arched bays, runs along the east and south sides and around the southern tower, forming a characteristic feature, with a real ship's deck for flooring. Brownstone and cream-colored brick are the materials of construction of the main building.

In general appliances, it may be termed a first class hotel. It has, in the domestic department, a kitchen with the best cooking apparatus, extensive ice boxes and cold storage rooms, a steam laundry, with steam washers, porcelain wash tubs, centrifugal and hot chamber driers and steam mangle, a butler's pantry with steam tables, and several dining rooms. The main dining room is for the guests and boys; the others are for the different classes of help.

The dormitories occupy several floors. Each is a double or single bedded room, with stained wood furniture, iron bedstead, single or double, with art rug on the floor, and in all respects equal to the accommodations

of old time ships and steamboats. A beautiful reproduction of the *Dunderberg* occupies one table. Elsewhere is a wooden ship builder's model of a hull saved from the ruins of his father's yard after a fire. The model is badly scorched but is still an interesting example of the lines of the old time American sailing craft. Here, too, is an interesting piece of furniture, a solid mahogany table from the Khedive of Egypt. It was part of the equipment of the *Dessoug*, the ship which brought over the obelisk to New York from Egypt.

The library, with its cases, table, and miscellaneous books, is one of the most pleasing rooms, and far up in the north tower is another recreation room, the gymnasium. It is questionable if a more lovely view can be had in the city than that from the windows of this apartment. The Hudson River, the government works at Spuyten Duyvil Creek, and Long Island Sound, can all be seen from it.

The institution is in charge of Mr. Andrew Reed, the resident and managing director, and Mrs. Alice Howard Hilton, the well known authoress, as superintendent, to whom our thanks are specially due for attentions conferred. The architect of the building was Mr. Arthur P. Jennings, of this city.

study the necessities of the trade and report to their employers. One man at first might represent several branches of trade. The government can never build up a trade with these countries. Our countrymen formerly had an instinct for foreign trade; they must cultivate it anew.

There is a great field here for our simplest agricultural implements—plows, hoes, etc. The machete is the agricultural implement used here. If a live man were sent here with plows, hoes, and other simple implements of agriculture, prepared to go on the haciendas and show the people how to use them, and the immense gain in using them, I do not think the result would be doubtful.

I have never seen corn meal in Ecuador; it is unknown, at least in the vicinity of Guayaquil, and yet large quantities of corn are produced. Corn mills might be introduced, with little expense, into the corn producing regions, such as that of the rich lands on the Boliche River, where I ate several meals at a great hacienda where there was not seen a crumb of bread, except what our party carried along. Yet on this place were hundreds of bushels of very fine corn. *Yuca* is used instead of bread. It is a great root, somewhat like the sweet potato of our Southern States.

## Progress of Preventive Medicine.\*

BY JAMES F. HIBBERD, LL.D., M.D., RICHMOND, IND.

Ten years ago the only known means of preventing the invasion of any country or city by cholera was to exclude every person and thing contaminated by the germs of the disorder. In 1884 cholera was epidemic and severe in Egypt, and was soon transported to Southern Europe. Germany, England, France, and Italy each appointed a commission of practical medical men and expert bacteriologists to inquire into the nature of the malady and devise means of prophylaxis. No better illustration of the rapid progress of preventive medicine and the manner of that progress can be desired than a study of the methods of investigation pursued by those commissioners and the formulated results of their labors. Their investigations began in Egypt, continued in Europe, and were complete in India, where cholera has its continuous renewal and perpetual home. The results of their labors were not entirely harmonious at first, but the unequalled Koch, at the head of the German commission, made a detailed report of the work and established the facts, the accuracy of which has been conceded by all parties.

Accordingly, we now know that the cholera germ is the spirillum cholerae Asiaticæ—commonly called the comma bacillus of Koch—that it is found in the human body only in the intestines of its victims, where it multiplies rapidly; that it is not communicated directly from person to person, but the alvine evacuations of the victims find their way, generally through water, into the bowels of susceptible persons, who then become additional victims; that this germ also finds a breeding place in damp soil and in stagnant pools and in running streams containing organic matter, and survives in pure water, but does not multiply there; that it is virile only within narrow thermal limits; that it holds its life by a frailer tenure than any other equally prolific and destructive pathogenic spirillum, being quickly destroyed by the official germicides, by drying, by acids, and by a temperature below 56° or above 126° F.

It is the application of this exact knowledge that has confined the cholera to the quarantine dominions at New York, thus preventing its diffusion in the United States; and it is a like application of this knowledge that has, on sundry occasions and at divers points in England and on the Continent, enabled the authorities to confine the Asiatic plague to the single case in which it was discovered. And, per contra, it is ignorance of these established facts, or failure to use them, that permits the ravages of cholera at this time in Arabia, in Russia, and on the shores of the Mediterranean.

Every practitioner of medicine in this country should feel it an obligation to constitute himself a propagandist of the knowledge of the means of prevention of cholera among the populace, and when the people are thoroughly informed in this behalf and join intelligently and heartily with the health authorities in recognizing and managing the first case that may appear in any locality, the disease will be stamped out at that point, and then cholera can never again become epidemic in the United States.

## YELLOW FEVER.

Yellow fever is another scourge that has been and still is being much studied, and not with such satisfactory results touching the nature of its course as with cholera, but enough has been determined in regard to its nature to warrant the declaration that it can be stamped out at any point where it may appear. All that is necessary to protect us from further invasion of yellow fever is the watchfulness, the intelligence, the skill, and the devotion to duty everywhere that has been so successfully exercised for eight years by the health authorities at New Orleans.

It is known that yellow fever is an exotic in the United States, and that it comes to us almost exclusively from the inter-tropical islands and mainland on the eastern border of the Western Hemisphere, and it is a reasonable anticipation that the diligent expert investigation now actively prosecuted will presently yield us such knowledge of the nature of its germ and its nativity as will enable us to strangle it in the place of its birth. The pregnant idea of dealing with germ diseases, that have a localized origin, at the point of their generation was under consideration by the Pan-American Medical Congress at its first session in Washington in September, and it is just such great organizations as that, composed of men with enlightened minds and courageous natures, that will work out the problems of sanitary science and art for the welfare of the world.—*Jour. Amer. Med. Assn.*

THE American Teredo Proof Company has erected works at Gig Harbor, Puget Sound, where piling for wharf and dock building is treated with a patent preparation, after which, it is claimed, they will withstand all attacks by the destroying teredo.

\* Abstract of Address on General Medicine, at a meeting of the Mississippi Valley Medical Association, October 12, 1893.

## INTERESTING EXPERIMENTS.

BY PROF. F. J. HILLIG.

*I. Experiment with Turpentine Film on Water.*—Cover the surface of water in a tank of about two feet diameter with lycopodium. Put in the middle of the part covered a drop of turpentine. A very striking action ensues. The turpentine sweeps in a moment the lycopodium from the center away toward the circumference of a large circle, which it clears perfectly of any trace of the powder. Besides illustrating the behavior of the film toward the lycopodium, the experiment shows the velocity with which such a film spreads over the surface of water, and finally may serve to give an approximate value of the thickness of the film. Taking *v. g.* 15 cub. mm. of turpentine, the surface of the circle covered by the film will be found to measure about 30 cm. in diameter. Applying

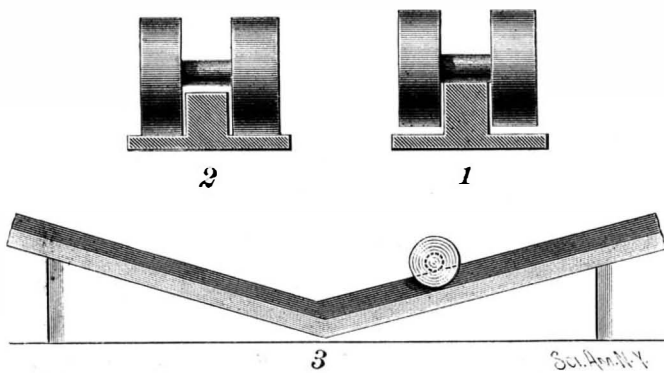

EXPERIMENT IN GRAVITY.

the formula of the cylinder's volume:  $V = r^2 \pi h$ , the value of  $r = 150$  mm., we have:

$$15 = 150^2 \pi h, \text{ therefore} \\ \text{thickness} = h = \frac{15}{150^2 \pi} = \frac{1}{4712} \text{ mm.}$$

*II. Experiment in Gravity.*—Fit together three cylindrical pieces of wood, as shown in Figs. 1 and 2, to make a double wheel. Then procure two rails about two feet long, with a projecting part in the middle, as in cross section, Figs. 1 and 2. The projection of Fig. 1 will be noticed to be longer than that of Fig. 2, and the distance from the axle to the rims of the wheels to be less than projection in Fig. 1 and more than that in Fig. 2. Now put the two rails with their ends close together, supporting the opposite ends, to produce slight inclination. So the apparatus is ready for use. Set the wheel on upper end of rail No. 1. Since the projection is greater than the corresponding groove of the wheel, the latter will roll down on its inner cylinder, producing a very slow run, but a certain momentum will be developed which, as soon as the wheel strikes rail No. 2, will change the rate of velocity to a much higher degree, because on the second rail the wheel runs on its outer cylinders. Thus you have a wheel running faster up hill than down.

As will be understood, the projection of rail No. 2 is used only to deceive the eye.

*III. An Optical Illusion.*—Between the electrodes of a Holtz-Toepler machine place an electrical whirl

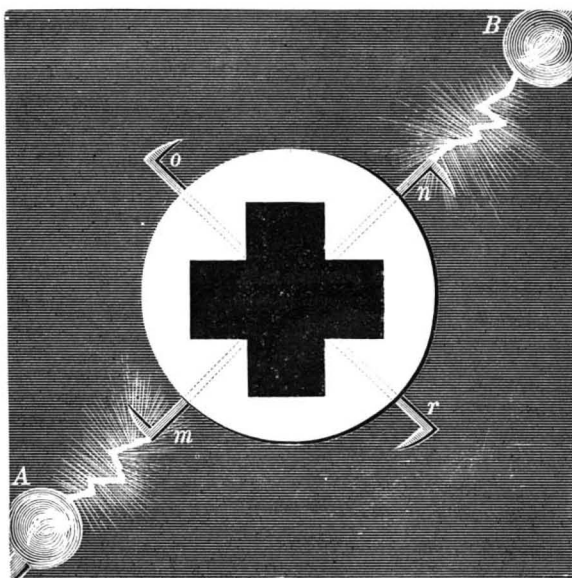

AN OPTICAL ILLUSION.

at the same level with the electrodes. To the whirl you fasten a circular piece of stiff white paper with some regular figure on it in black. The pivot on which the whirl is to rotate should be insulated. After a few seconds of running your machine, sparks will pass over every time when the wire, *m n* or *o p*, takes the direction of *A B*. This experiment performed in the dark will show the cross always in the same position, thus giving the whirl the appearance of being at rest, though it moves rapidly.

## Sugar Beet Items—Germany.

Most excellent results have recently been obtained in beet cultivation by planting and subsequently plowing under a green crop, such as peas. It is found by accurate calculation that nitrogen may be thus furnished to the soil at lower cost than is possible either by the use of barn-yard manure or through chemical salts, such as sodic-nitrate, etc. About 20 tons of beets, averaging 13 per cent sugar to the acre, have been obtained by this special method of cultivation.

A mode of working beet sirups for second and third grade sugars has been giving some success. Immediately after the sirups leave the pan, while still hot, air is forced through them. After twenty-four hours there forms a voluminous frothy mass, which has a specific gravity less than water. If this is allowed to remain in the crystallizing tanks, nearly all the sugar of the sirup will crystallize. The separation of this sugar offers no special novelty; it is interesting to note, however, that the sugar obtained by this process averages a very low percentage of ash. The tanks used for mixing the air with sirups are made very much after the plan of those used in saturation of beet juices with carbonic acid. The air may be either forced through or drawn through; the time required depends upon the quality of the product worked.

Recent experiments show that electricity has one effect upon beet juices that is not to be overlooked. The sugar percentage increases, but this is followed by a slight decolorization. About 50 per cent less time in such cases is needed for defecation than by ordinary methods of carbonatation. When zinc is used as an electrode, the metal is dissolved; one portion of it becomes a neutral double salt and the other portion a zincate, which gives an alkaline reaction to the juice.

When platinum is used as an electrode, inverted sugar is formed; this is never to be dreaded with zinc. Other experiments upon diffusion juices, with an electric current from a Siemens dynamo giving 35 to 40 amperes with 4 to 5 volts between the zinc electrodes, resulted in a deposition on the positive pole of a thick, fatty substance. This should be withdrawn before the juices are defecated with lime. The electric current coagulates the albumen to a certain extent. While certain explanations may be offered as to the reactions, etc., that take place, none are sufficiently accurate to be generally accepted.

The sugar manufacturers have declined to accept the proposal of the sugar refiners respecting raw sugars of 88°. Special arrangements have been made as regards sugars testing 92°. The latter are almost free from organic substances. It has been recommended that considerably more of the 88° sugar be made than hitherto; under such circumstances the manufacturers may be better able to make terms with the refiners.

The problem of handling waste waters from beet sugar factories is by no means settled. The water residuum, most to be dreaded, comes from the diffusion battery and pulp presses. In some special cases, where there is a scarcity of water, this waste water must be used over again. Notwithstanding the precaution of purification, such as employed, after a reasonable time the salts, etc., not eliminated give considerable trouble during manufacture.

The experiments made in crystallization in motion appear to continue in favor among manufacturers, most of whom are willing to admit that by this plan more sugar may be extracted from second and third grade sirups than by any other existing method.

Some most interesting experiments have been made to determine the loss of sugar during evaporation of alkaline juices. After 90 minutes a solution containing 250 grammes sugar, 20 c.c. potassic solution, 230 grammes water, heated to 125° C., polarized 49.11, corresponding to a loss of 0.74 in the polarization. All experiments appear to point to the fact that alkalinity resulting from existing methods of working has but little influence on sugar destruction; what changes do occur may be mainly attributed to heating.

Exportation of beet sugar from Hamburg has remained almost stationary during the past four years. During 1892-93 it was 653,722 tons, of which England received 242,515 tons refined sugar.

Slices of cork have been giving most excellent results in filter presses; these obviate many of the difficulties contended with in filtering very dense sirups. The expense is about \$10 per 10,000 tons beets. The cork offers an excellent medium for several days without being renewed; in fact, even then it may be washed in the presses, which operation demands about one-half hour. The cork may remain in the presses for a month, provided it receives its regular washing at intervals of one week. The filling and emptying cork requires less time than the renewing of filtering cloths. Any bone filter may be changed into a cork filter.—*The Sugar Beet.*

THE first coast light in the United States was erected in 1678.



**A Wire Tramway in the Alps.\***

A wire tramway having some very long spans has recently been built by Bullivant & Co., of London, from the designs of Mr. W. T. H. Carrington. This tramway has been built to carry tale from mines at a high level in the Italian Alps, on the Franco-Italian frontier, near Pinerolo, for Brayda & Co., of Turin. The mines are situated at a height of about 7,000 feet above the sea, and the material has to be carried to a road situated at a level of about 2,500 feet above the sea, whence it is carted to the railway station at Pinerolo. The mines occur at various points along the line of tramway, and the quantity transported per day is about forty tons. The return traffic up the tramway consists of military stores required for the use of the fortresses erected for the defense of the Italian frontier at various points along the mountain range. The wire tramway erected consists of one upper span, having a length on the incline of 3,090 feet, with a gradient of 1 in 4. A length of ground tramway proceeds from the lower end of this section, by which the material is collected from various mines situated on the lower plateau, and over which the material brought down by the upper section is transported to the upper terminal of the second incline. The latter ropeway is 4,200 feet on its inclined length, and has a gradient of 1 in 2½. From the lower end of this the third incline extends to the roadway above named, the length of this lower incline being, on its inclined length, 3,600 feet, with a gradient of 1 in 2. The nature of ground traversed by this latter incline necessitates the use of a support on a ridge about one-third of the distance from its upper terminal, and at this point the fixed ropes are supported in suitable saddles, over which the carriers run, and the hauling ropes are carried on suitable guide wheels. The upper portion of this lower incline, thus divided by this support, has an incline of about 1 in 2, whereas the lower section has an incline of 1 in 1¾.

All these inclines are constructed on the principle adopted on many other lines of a similar character; two fixed ropes are stretched from end to end of the incline, and an endless hauling rope is employed, which, at the upper end, passes round a suitably devised brake gear, while at the lower end it is passed round a tension pulley, by means of which suitable strain is put on this rope.

\* Abstract of article in the London Engineer.

The carriers are designed to contain about 600 lb. of mineral, and arranged to tip on the release of a catch. The running heads from which they are suspended, and by means of which they run on the fixed ropes, are provided with steel wheels carried in a wrought iron frame in which the hanger of the carrier pivots and moves freely. The attachment of the hauling rope is made to the head by means of suitable pendants, to enable it to pass the point of support. The fixed ropes are tightened by means of blocks fitted with Bullivant's patent flexible steel wire rope, and a crab winch placed in the rear of the same. This mode of tightening is found most convenient, as it admits of the fixed ropes being slacked out on to the ground for examination at any time without releasing the attachments, the wire rope falls being provided of sufficient length for this purpose.

The great length of the second span will be noted; it provides a means of transport for a load having a gross weight of about 1,150 lb. The fixed cables are composed of specially made steel wire rope having a breaking strength of about 35 tons; they are made of steel wire of special character to suit the requirements of this description of work. Great care is taken in the attachment of these ropes at the ends, where they are held by patent clamps, arranged to avoid the necessity of splicing, and by means of which the rope is not weakened at the point of attachment. The carriers are allowed to travel at a speed of about 35 miles per hour. The whole section is controlled by one brakeman, who, when not employed in controlling the running of the line, is occupied in loading the carriers, etc.

The transport of the materials discharged at the lower end of the middle section to the upper terminal of the lower section is performed by small trucks which run on a short line of railway between the two points. With the small quantity of mineral required to be carried, the use of this arrangement involves no extra labor; where, however, it is necessary, a direct interchange of loads from one bucket to another can be arranged, but this is only desirable where the quantity to be carried is very considerable. The support placed in the lower incline consists of a timber frame of ample strength, between the uprights of which is suspended a steel transom carrying saddles on which the fixed ropes rest, and between these same uprights, at a lower point, will also be seen the wheels with their guide bars arranged for carrying the hauling rope, by means of which the loaded carrier when descending brings

the empty carrier up. When it is not required to transport any mineral the descending loads are composed of stones, etc., by means of which the military stores are transported up the mountain. It is found that with 600 lb. of mineral in the descending carrier about 250 lb. of military stores can be brought up in the ascending bucket.

**Injurious Photographic Chemicals.**

The *British Journal* says: Metol seems to be gaining, rightly or wrongly, an unenviable character for the injurious action it is said to exercise on the hands of its users. But, be it ever so hurtful, is there any reason why it should be allowed to exert its ill effects? In the development of negatives, only the extreme tips of the forefingers and thumbs need be wet with the solution, and then only the front portion of them, where the skin is the thickest. In most instances, in handling injurious chemicals, it is only when they come in contact with the thinner portions of the skin—as on the back or between the fingers—that any harm results. However, India-rubber finger stalls, costing but a few pence each, are to be had at all rubber shops, that will perfectly protect the fingers from all pernicious materials. They are much more extensively used by photographers, both professional and amateur, on the Continent than they are here. Being exceedingly thin, they are by no means uncomfortable to work in. It is curious to note the effect that different chemicals have on different persons. One gentleman we knew, who for years had been dealing with impunity with cyanide of potassium in connection with electroplating as well as photography, suffered severely from bichromate of potash. Another gentleman, on whom the bichromate was innocuous, even when used on a large scale, could scarcely touch cyanide without suffering inconvenience. Even the smell of it created nausea and headache. In the wet-collodion days, a friend of ours had to relinquish photography, so far as the development of his negatives was concerned, on account of the injurious action the iron solution had upon his hands.

**Underground Conduits in New York City.**

The underground electrical conduits in New York City have now a length of 1,667 miles. In these conduits there are about 32,600 miles of telephone and telegraph wires and 1,300 miles of wires for lighting purposes, with which about 6,790 arc lights and 268,000 incandescent lamps are connected.

**RECENTLY PATENTED INVENTIONS.****Engineering.**

**ENGINE GOVERNOR.**—William H. Watson, New Orleans, La. According to this invention the steam passes through the governor on its way to the engine, and the speed of the engine is thus regulated to a nicety without using any gearing or exterior mechanism. The governor comprises a casing, having an inlet at one end and an outlet at the other, a percussion plate being held in the outlet end, while there is a central chamber through which slides a piston having end chambers with ports leading to the central chamber. The regulating piston is moved back and forth automatically by the shifting steam pressure.

**Railway Appliances.**

**CAR COUPLING.**—William F. White, Chicago, Ill. This is an improvement in knuckles of the Janney type, and consists principally of a pivoted knuckle held on the drawhead and provided with an extension adapted to be engaged by the forked end of the coupling pin. The extension has a beveled portion, and its front and rear edges are adapted to be engaged by two parallel prongs of the pin, the rear most of the prongs having a lug engaging the beveled portion of the extension, while a lug in the drawhead is adapted to be engaged by the pin to impart a swinging motion to the latter when a pull is exerted.

**AIR BRAKE COUPLING DEVICE.**—Charles F. Bane, Lafayette, Ind. The hose coupling, according to this invention, has two movable interlocking sections, each with a lug and two stop lugs and a ported valve within each section, there being on the stem of each valve an arm having limited movement between the stop lugs of its own section and adapted to be engaged by the lug on the section carrying the other valve, to be moved against one of the stop lugs of its own section. The device automatically opens the valves in the couplings, whenever the coupling members are united, thus forming an uninterrupted passage for the air in the train pipes on adjacent cars.

**AXLE BOX LUBRICATOR.**—James S. Patten, Baltimore, Md. This is an improvement on a former patent of the same inventor, according to which there is inserted and held in the car axle box proper a box containing a liquid lubricant, with means for taking up the lubricant and transferring it to the journal; also for reconveying into the box any surplus which may accumulate on the journal. The improvement having been practically adopted by several railroad companies, the inventor has devised and covers in this patent a better working form, more completely adapting it to everyday use on railroad cars in ordinary service.

**Electrical.**

**ELECTRICAL RESISTANCES.**—George B. Lawrason, New Orleans, La. An instrument for measuring and regulating these resistances, on the principle of the Wheatstone bridge, has been devised by this inventor. The conductors are wound in exterior spiral grooves on a rotatable non-conducting cylinder, the adjustment

shortening or lengthening the distances between the point bridged from the main circuit, and a conducting rod composed of two aligned but insulated parts is arranged parallel with the cylinder and adapted to rotate. The conductors wound in the grooves of the cylinder are also looped around the rod, so that the current is not only divided and caused to take two paths, but the resistance may be varied at will by rotating the cylinder.

**RAILWAY SIGNALING APPARATUS.**—Edgar C. Wiley, Bristol, Tenn. The principle employed in this invention comprises a series of electro-magnets in the roadbed or along the line and energized through contacts made mechanically by the passage of the train, these magnets acting by induction upon magnets carried by the locomotive, which pass the stationary magnets so closely as to induce in the magnets of the locomotive a current strong enough to close a local bell circuit on the train and sound the signal, thus apprising the engineer of any train of the presence of another train upon the same section of track.

**SERIES ELECTRIC RAILWAY.**—Michel Angelo Cattori, Rome, Italy. The conductor, according to this invention, consists of fixed separated and insulated conducting sections and movable conducting circuit breakers in the gaps between sections, to be operated by the locomotives to open or close the gaps, while four conducting wires connect the generating machine with the conductor in sets of two at two separate points, the conductor being interrupted between the two wires of each set, and there being means for electrically connecting the poles of the machine with either of the sets of conducting wires. The invention embraces many other novel features for an improved series system electrical railway with underground conduit.

**Mechanical.**

**NUT LOCK.**—John W. Schoaf, McKeesport, Pa. This is an improvement in nut locks, employing a spring washer formed of a spring-split ring, with ends projecting in opposite directions to act as pawls, and the invention consists in fitting a guard plate over the spring washer, so that the washer may be partly compressed, but cannot be mashed flat and so be damaged or made useless. The plate does not prevent the proper operation of the spring washer.

**COMBINATION TOOL.**—Riley L. Davis, Asheville, N. C. This tool has a hammer or socket head, to which is secured a cutting or clipping tool, and to the latter is detachably secured a supplemental tool for cutting wire, or for use as a screw driver or wrench. The handle of the hammer head is so secured in a tapered socket that shrinkage or wear of the handle may be readily taken up to insure a tight fit at all times.

**SAW MILL FEED MECHANISM.**—William Fleming, Athens, Ga. This is a variable feed device, comprising a pivoted rotary shaft and shiftable friction disk mounted on a sliding sleeve, to which is pivoted a hand lever. By moving the lever in either of two directions, at right angles to each other, the log carriage is fed either forward or back, while by moving the friction wheel longitudinally on the shaft the speed of the carriage is regulated.

**TREADLE ATTACHMENT.**—Andrew Prader, Spokane, Wash. This is a simple attachment designed to prevent dead center positions, so that the driven shaft is rotated in a forward direction on starting the treadle. A flat spring is so arranged in connection with the pitman and treadle as to exert pressure against the upper end of the pitman, and consequently on the wrist pin, to hold the latter out of a dead center position relatively to the treadle whenever the machine is stopped.

**Agricultural.**

**WEED CUTTER.**—Robert H. Douglass, Colville, Wash. This machine has main cutters of V-shape so placed that their inner edges will be their cutting edges, the angle of the cutters being at the rear, and in conjunction therewith are upright cutters and means whereby the cutters may be quickly and easily adjusted to cover more or less ground, or adapt themselves to rows of different widths. The machine is of very simple, strong and inexpensive construction.

**Miscellaneous.**

**VENTILATION OF BUILDINGS.**—William M. Decker, Kingston, N. Y. This inventor has devised a special method of construction in which air shafts lead from the cellar to outlets at the top of the building, communicating with spaces under each floor, while pipes lead from the cellar also to these spaces, there being means for inducing an upward flow of air; there are also air spaces in the several walls of the building, and lateral openings leading from the floor spaces to the wall spaces, and from the latter to the air shafts. The construction affords means for accurately controlling the heat supplied to different rooms, and effectively removing the foul air.

**GRIP TESTING MACHINE.**—Theobald E. J. Schaibly and Walter Schaibly, Philadelphia, Pa. This is an improvement on a machine formerly patented by one of these inventors, simplifying the construction, and providing means for connecting the tension springs directly to the handle levers and the sides of the case. There is also a connection between the levers and a registering mechanism thrown into gear by dropping a coin into a chute of the machine, the levers being thrown out of gear as soon as they are started, so that they cannot again operate the registering mechanism until another coin is dropped. A brake mechanism holds the indicating hand at the point it reaches, the mechanism being released and the hand returned to normal position on pressing a button.

**FOLDING BEDSTEAD.**—Paul Gustave Le Dan, Paris, France. This bedstead is intended primarily for use by officers on campaign, explorers, and others. The side pieces are each formed of two sections hinged together, the foot piece being detachably connected and carrying a foot at each end, while there are feet hinged to the head sections of the side pieces, and an adjustable and hinged back. These bedsteads are preferably made of copper tubes, to weigh only about ten pounds, and have a novel style of coupling and fitting whereby they may almost immediately be transformed into a long chair, an easy chair, or a stool.

**WIRE FENCE GATE.**—William W. Halladay, Farina, Ill. This gate forms really only a part of the fence, and is so cheap and simple that it may be applied at frequent intervals between the posts of the fence to afford openings at any desired point. To the free ends of the strands of a fence section is fastened a stile whose lower end is held to a post by a common staple, while near the upper end of the stile is a link engaged by a hook extending through a hole in the post, the back of the hook being pivoted to a cam lever. When the gate is opened the stile and wires are carried to one side, or the wires may be rolled on the stile.

**WIRE STRETCHER.**—William P. Negus, West Branch, Iowa. This is a simple device especially adapted for stretching any kind of woven wire fencing, working equally well with barbed or smooth wire, and adjusting itself to any size of wire. It is a forked lever whose prongs have inclined ends, a dog being pivoted between them and having shoulders adapted to swing opposite the inclined ends of the prongs, while there is a toothed cross piece on the free end of the dog. The device is strong and durable, holding the wire very firmly. It is also useful in repairing old, loose fences, as well as for stretching new fence.

**WEATHER STRIP.**—Norman N. Hazelton, Lamoni, Iowa. This strip comprises a spring plate secured to the outer face of the door, its lower end riding on the threshold piece, while a catch member has a shank portion passing through the door and engaging the inner face of the threshold strip. The device is simple and inexpensive, but is designed to effectively exclude all rain, snow and wind, and also to serve as a door stop or bumper to protect the wall and wall paper.

**TRAVELING CASE.**—Florence I. Leonard, Arlington, Ga. This is a case designed to be especially useful for ladies as well as gentlemen for short trips, and has apartments to properly contain several dresses, lingerie, hats, etc. Its main compartment is preferably about two feet long, sixteen inches wide and nine inches high, and hinged thereto is a top section on which are hat boxes, the case also having the conveniences of a dressing case.

**INHALER.**—Alfred M. Adsit, Hastings, Minn. This is a device for the administering of anesthetics, and has a hollow body with top air inlet, a liquid reservoir and liquid discharge regulator, and a series of minutely perforated partitions supporting bibulous material. The device provides for the gradual and measured giving of the anesthetic as desired, according to its effect upon the patient.

**DENTAL CLAMP.**—Joseph M. Strout, Portland, Me. This is a device which may be used upon any tooth of an upper or lower set, being out of the way of the operator, quickly applied or removed, and effectually holding the rubber dam in position, while at the same time pressing the gum from the neck of a tooth in such manner as to expose a cavity well down in the neck. The clamp has a yoke-like spring body, with adjustably attached extension arm shaped to embrace the neck of a tooth other than the one engaged by the clamp.

**ATTACHMENT FOR STOOLS.**—Thomas S. Crapp, Tallapoosa, Ga. This is a device for piano

seats, screw chairs, and other seats supported on a vertically adjustable screw spindle. It is a spring attachment, which, when the spindle is turned down, acts as a bracing sleeve to strengthen and sustain the spindle, preventing it from sticking, and acting automatically to loosen and slightly turn back the spindle after it has been turned forcibly down.

**BANJO.**—Charles E. Dobson, New York City. In the head of this instrument the rim is beveled on its inner side at both edges, and tubular rings rest against the bevels, with their outer sides flush with the outer face of the rim and their opposite faces beyond the upper and lower edges of the rim. The device is designed to improve the tone of the instrument and at the same time strengthen the upper and lower portions of the rim of the head without adding unduly to the weight.

**INSECT TRAP.**—Allen Y. Smith, Eddy, New Mexico. This trap is of pyramidal shape, with smooth funnel-shaped entrance at the top, and wire gauze sides and ends, with removable sliding bottom. It is more especially designed to trap roaches, affording them an easy entrance but preventing their escape.

**NOTE.**—Copies of any of the above patents will be furnished by Munn & Co., for 25 cents each. Please send name of the patentee, title of invention, and date of this paper.

**NEW BOOKS AND PUBLICATIONS.**

**THE PRACTICAL ELECTROPLATER.** By Martin Brunor. New York and London: Emile Brunor. 1894. Price \$10.

This work has the advantage over several other volumes published in the same line in being largely the result of the personal researches and experience of the author, many of the processes described being here for the first time given to the public. In Paris, as well as in this country, the author addressed himself to mastering all the details of electroplating as exemplified in the workshop rather than as theoretically set forth. It is, therefore, a book for practical men, giving some two hundred articles and formulas for solutions, describing process for gilding with and without a battery, for oxidizing, fire gilding, etc.

**SCIENTIFIC AMERICAN BUILDING EDITION.**

FEBRUARY, 1894.—(No. 100.)

**TABLE OF CONTENTS.**

1. Elegant plate in colors showing a suburban dwelling at Plainfield, N. J., erected at a cost of \$4,800 complete. Floor plans and perspective elevation. A tasteful design. Messrs. Rossiter & Wright, architects, New York.
2. Plate in colors showing an elegant residence at Pelham Manor, N. Y. Perspective view and floor plans. Estimated cost \$7,000 complete. An excellent design.
3. The Jamaica Club House, recently erected at Jamaica, N. Y. Perspective views and floor plans, also an interior view. Cost \$9,000 complete. Messrs. Haus & Osborne, architects, Brooklyn, N. Y.
4. A beautiful residence at Portchester, N. Y., recently erected for A. V. Whiteman, Esq. Perspective and floor plans. Mr. Frank W. Beall, architect, New York.
5. Engravings and floor plans of a suburban residence erected at Ashbourne, Pa., at a cost of \$4,800 complete. An attractive design. Harrison Allbright, Esq., architect, Philadelphia, Pa.
6. A suburban dwelling recently erected at Edgewater, Ill., at a cost of \$10,216. Floor plans and perspective elevation. Mr. F. B. Townsend, architect, Chicago.
7. A colonial cottage at Buena Park, Ill., recently completed for Guy Magee, Esq. Floor plans and perspective elevation. An artistic design.
8. A modern half-timbered cottage at Wyncote, Pa., erected at a cost of \$4,250 complete. Floor plans and perspective elevation. Mr. A. S. Wade, Philadelphia, Pa., architect.
9. A modern colonial residence at Oak Lane, Pa., erected at a cost of \$6,800 complete. Perspective view and floor plans. Mr. F. R. Watson, of Philadelphia, Pa., architect. An attractive design.
10. The residence of Rev. Samuel Scoville at Stamford, Conn., erected at a cost of \$6,616. Mr. W. W. Kent, architect, New York. An excellent design.
11. Examples of interior decoration and furniture in the Moorish style.
12. A Queen Anne dwelling at Jenkintown, Pa., recently completed at a cost of \$5,000. Messrs. Burke & Dolhenty, Wyncote, Pa., architects.
13. Miscellaneous Contents: The growth of plants in odd places.—Acoustics in buildings.—Improved steam power brick machine, illustrated.—A new style stamped ceiling, illustrated.—The telethermometer or distant temperature indicator.—The improved Thatcher furnace, illustrated.—Improved sash chains and fixtures, illustrated.—An improved sliding door latch, illustrated.—Aluminate in cement plaster.—Fire losses of 1893.—Graphite paint.—The Columbian sash and door lock, illustrated.—An improved sash lift, illustrated.

The Scientific American Architects and Builders Edition is issued monthly. \$2.50 a year. Single copies, 25 cents. Forty large quarto pages, equal to about two hundred ordinary book pages; forming, practically, a large and splendid MAGAZINE OF ARCHITECTURE, richly adorned with elegant plates in colors and with fine engravings, illustrating the most interesting examples of Modern Architectural Construction and allied subjects.

The Fullness, Richness, Cheapness, and Convenience of this work have won for it the LARGEST CIRCULATION of any Architectural Publication in the world. Sold by all newsmen. MUNN & CO., PUBLISHERS, 361 Broadway, New York.

**Business and Personal.**

The charge for insertion under this head is One Dollar a line for each insertion; about eight words to a line. Advertisements must be received at publication office as early as Thursday morning to appear in the following week's issue

"U. S." metal polish. Indianapolis Samples free.

Air compressors for every possible duty. Clayton Air Compressor Works, 26 Cortlandt Street, New York.

The Improved Hydraulic Jacks, Punches, and Tube Expanders. R. Dudgeon, 24 Columbia St., New York.

Nickel-in-slot machines perfected and manufactured Electrical supplies, Waite Mfg. Co., Bridgeport, Conn.

Screw machines, milling machines, and drill presses. The Garvin Mach. Co., Laight and Canal Sts., New York.

Centrifugal Pumps for paper and pulp mills. Irrigating and sand pumping plants. Irvin Van Wie, Syracuse, N. Y.

Carborundum—hardest abrasive known. Send for prices of wheels, powder, etc. The Carborundum Co. Monongahela, Pa.

Emerson, Smith & Co., Ltd., Beaver Falls, Pa., will send Sawyer's Hand Book on Circulars and Band Saws free to any address.

Split Pulleys at low prices, and of same strength and appearance as Whole Pulleys. Yocom & Son's Shafting Works, Drinker St., Philadelphia, Pa.

The best book for electricians and beginners in electricity is "Experimental Science," by Geo. M. Hopkins. By mail, \$4; Munn & Co., publishers, 361 Broadway, N. Y.

Patent Electric Vise. What is claimed, is time saving. No turning of handle to bring jaws to the work, simply one sliding movement. Capital Mach. Tool Co., Auburn, N. Y.

Competent persons who desire agencies for a new popular book, of ready sale, with handsome profit, may apply to Munn & Co., Scientific American office, 361 Broadway, New York.

Send for new and complete catalogue of Scientific and other Books for sale by Munn & Co., 361 Broadway, New York. Free on application.

**Notes & Queries**

**HINTS TO CORRESPONDENTS.**

**Names and Address** must accompany all letters, or no attention will be paid thereto. This is for our information and not for publication.  
**References** to former articles or answers should give date of paper and page or number of question.  
**Inquiries** not answered in reasonable time should be repeated; correspondents will bear in mind that some answers require not a little research, and, though we endeavor to reply to all either by letter or in this department, each must take his turn.  
**Buyers** wishing to purchase any article not advertised in our columns will be furnished with addresses of houses manufacturing or carrying the same.  
**Special Written Information** on matters of personal rather than general interest cannot be expected without remuneration.  
**Scientific American Supplements** referred to may be had at the office. Price 10 cents each.  
**Books** referred to promptly supplied on receipt of price.  
**Minerals** sent for examination should be distinctly marked or labeled.

(5801) F. W. G. asks: 1. In tin plating iron or steel by immersion in melted metal, what materials are used as a flux and what as the bath after they have been dipped? A. Our SUPPLEMENT, Nos. 92, 130, 249, gives notes on the tinning process. 2. To what resistance should the magnets of an electric bell be wound, for use as signal on a telephone line one-half mile in length, and what size of wire is best suited for winding them? A. The smaller the resistance and larger the wire the better. It is a practical question. 3. How many cells of Leclanche battery at each end of line will be required to work bells satisfactorily where No. 14 iron wire is used with return wire? A. Three or four. 4. How many cells where No. 18 copper wire is used, and how is this determined? A. Three or four. All depends on the bell, how strong a spring it has and what current is needed to ring it. We recommend for your perusal the following works, which we can supply. Allsop's "Electric Bell Fitting," \$1.25; same, "Electric Bell Construction," \$1.25; and Botton's "Electric Bells and All About Them," 50 cents, by mail, prepaid.

(5802) A. M. T. asks: 1. What is gained by winding 750 feet, or 300 of No. 12 double-covered wire, on an armature 6 inches long 9 inches in diameter, with an iron core 1 1/2 inch thick? What will be the difference of the revolutions with the same field in each case? A. If you refer to a motor, the more turns of wire you put on the armature, the lower will its maximum speed of rotation be. There is no absolute gain or loss. The winding must be adapted to the requirements of each case. Roughly speaking the rotations will vary inversely with the length of wire. 2. Will you please state the outside diameter of Nos. 12 and 14 double-covered magnetic wire? A. The wires are 80 and 64 mils in diameter respectively. For covering allow five mils or so.

(5803) C. E. C. H. says: 1. Please inform me as to the best form of reservoir to hold about 60,000 gallons, to be built on the surface of the earth, of brick and cement. How thick would the walls have to be to stand the pressure without fear of rupture, and what is the best form of outlet? A. The reservoir should have a diameter of 40 feet at the water surface and 10 feet deep. Brick is not desirable for reservoir walls, on account of its porous nature, and good hydraulic cement being expensive in Southern California, we recommend earth banks 12 feet high, 8 feet wide at top with banks sloping on inside 45°, outside 30°, making the bank at the bottom level not less than 32 feet wide. A 2 foot puddle wall of good clay and sand should be carried vertically on the line of the inner edge of the top, commencing in a trench at 3 feet below the bottom of the reservoir. A clay and sand puddle lining 1 foot thick should cover the entire bottom and inner slope of the sides. All puddle should be well worked and rammed. The pipe should be laid below the bottom and rising through the puddle and

well packed throughout with clay puddle. Valve outside of reservoir. 2. How much hay (weight) will a loft floor bear 16 feet across and 80 feet in length, resting on 2x8 joists 1 foot 9 inches apart? A. The floor will carry 4 1/2 tons of hay evenly distributed with safety.

(5804) C. O. M. asks how to make a small furnace suitable for melting from 10 to 25 pounds of cast iron; what to use to produce sufficient blast. A. The accompanying figures will give a very good idea of a small cupola for melting iron. Fig. 1 being a perspective view and Fig. 2 a section of the cupola. The body is made of heavy sheet iron, lined with firebrick, and provided with trunnions by which it is supported on cross bars in a frame composed of two iron plates about two feet square, separated by four 1/2 foot columns of 3 inch gas pipe, the whole being fastened together by four long bolts which pass through both plates and through the columns. The upper plate has a large opening and a flange or collar for receiving the base of the chimney. The cupola has openings on opposite sides to receive the blast nozzles or tuyeres, and a tap hole in front. It should be about 3 feet high, and 14 inches internal diameter. The base of the chimney should have a door through which to charge the cupola. The blast may be supplied with a large bellows, but a small fan blower will answer much better. For the quantity of iron mentioned a cupola two-thirds the size given would answer.

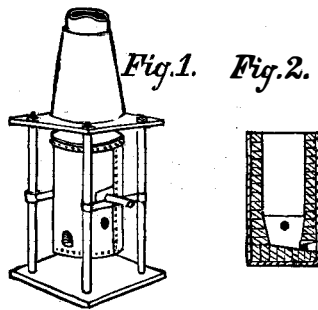

(5805) J. J. W. writes: Is it the practice among land surveyors to describe courses by the compass as the needle now points, or do they make the necessary allowance for the deviation from the true north? If nothing is said, in an old deed, in reference to this matter, which course is to be taken? What is the present correction for Warren County, N. Y.? Has it varied materially in ten years? How is the deviation ascertained? A. Surveys of land should have the courses designated from the true meridian, and the declination of the needle stated at the date of the survey in the deed and marked on the plot. The old surveyors were sometimes careless on this point or did not know the deviation of the compass at the time. If the declination is not stated in the deed, old or new, and not marked on the survey plot, the inference is that the compass courses are meant. In a resurvey this should be tried, by running the lines with a corrected compass declination equivalent to the difference of declination from the date of the deed to the present time, and by this means try to find some landmark of the old survey, or make a comparison with adjoining survey lines. The present declination for Warren County, N. Y., is 12 1/2° west. In 1884 it was 11 1/2° west, the increase being nearly 1° per annum. The deviation is ascertained by observing Polaris when on the meridian, or at its eastern or western elongation. The method is illustrated and explained at length in "Gillispie's Surveying," by Staley, \$3.50 by mail.

(5806) E. J. McC. asks: How would you go to work to figure the pressure per square inch exerted on a cylinder 2 feet long and 4 inches diameter filled with water or oil, if the piston is forced in by a screw of 1 1/4 inch diameter and 8 threads per inch? The screw is driven by a pulley of 4 inches diameter on which a rope is coiled with a 150 pound weight attached to the end. A. The rule is to multiply the power by the circumference of the screw and divide by the pitch, for the total pressure. The power is the radius of the pulley divided by the radius of the screw, multiplied by the weight. The total pressure divided by the area of the piston in square inches is the pressure per square inch. As in your case the power is  $\frac{2 \text{ mch}}{5/8 \text{ inch}} = 3 \times 2 \times 150 \text{ pounds} = 480 \text{ pounds}$ . Then  $480 \times 3.92 = 1505.26 \text{ pounds}$  and  $\frac{1505.26}{12.5 \text{ sq. inches}} = 1,204 \text{ pounds per square inch}$  pressure, less a deduction for friction of rope, screw and piston.

(5807) E. P. asks: 1. Is steam visible? If not, what is it that is seen coming from an engine? A. No. The white cloud is water in the vesicular condition, or forming minute globules. 2. Where is the fallacy in the following "proof"?  
 Suppose  $a=b$   
 then  $a^2=b^2$   
 and  $a^2=a^2$   
 and (taking  $b^2$  from both members)  $a^2-b^2=a^2-ab-b^2$   
 factoring,  $(a+b)(a-b)=b(a-b)$   
 dividing by  $(a-b)$  and  $a+b=b$   
 that is  $a+a=a$   
 $2a=a$   
 $2=1$

A. The fallacy is in treating  $(a-b)$  as a real quantity when it is really 0. You might just as well say  $1000 \times 0 = 1 \times 0$ , and then dividing by 0, we find  $1000=1$ .

(5808) R. W. M. asks whether it would be advisable in building an ice house and cold storage, if it is necessary to keep the ice room closed. Or can I, by building large, say 2,000 tons capacity, have cold storage under and use the ice from above daily for delivery? Your advice on this subject will be thankfully received. A. The building of a cold storage room in or under an ice house is practicable, with only the precaution to make the ceiling strong enough to bear the weight of ice above, and all parts water-tight by planking and calking or with a galvanized sheet iron covering and sides well soldered to keep the drippings of the ice out of the cold room. A drain around the outside of the cold room, with a connection to the ground to take away the water from the melting ice next to the cold room. The first ice sold should be taken from over the cold room, so that the

weight may be lessened, as it will become cavernous and may fall on the roof of the cold room and do damage. Otherwise the ice house may be used as usual in disposing of the ice, but in such a way as to leave the cold room inclosed with ice to the end of the season.

(5809) E. E. F. asks: 1. When will the star Myra be visible? A. Myra (o Ceti) varies from 1.7 to 9.5 magnitude. Its period is 331 1/4 days, remaining at its minimum magnitude about 231 1/4 days, when it begins to brighten, reaching its greatest magnitude in about 30 days, remaining brightest one week, then receding to its minimum magnitude in about 60 days. It is visible to the naked eye about 45 days. We have no record of its date of maximum brightness. 2. I have a constant flow of water that would fill a two inch pipe, with a fall of about 100 feet in 400. Now, would a pipe of say 2 1/2 or 3 inches diameter of that length (400 feet) be large enough to supply a Pelton wheel of about 1 1/2 or 2 horse power? Also size of wheel, number of buckets, and size of nozzle, also same for a 5 horse power wheel. I am glad to see that you have resumed the monthly record of the planets in your valuable paper. A. The amount of water that will fill a 2 inch pipe is not a measure of water flow. If you can measure 60 gallons per minute at the spring you may realize about 1 horse power, with a 12 inch wheel, 1/2 inch nozzle. Buckets 1 inch by 3/4 inch.

(5810) A. H. S. asks: 1. How many cells of storage battery are required to run a one horse power electric motor? A. It depends on the size of the cells. Twelve cells 35 ampere cells give it. 2. Can they be charged by gravity batteries, and if so, how many are required? Supposing the storage batteries can be charged by gravity batteries, how long time will be required? The motor I would run is wound for 110 volts incandescent current. A. Allow two and one-half gravity cells in series for each storage cell, and put as many as possible in parallel. Thus a one or two hundred cell gravity battery would be required to charge a small storage battery. But for your motor you would need 56 storage cells, and to charge these several thousand gravity batteries might be used; gravity battery charging is only applicable to small storage cells. 3. Where can I obtain a cheap practical book treating of storage batteries, their manufacture, care and application to motors? A. See Salomon's "Electric Light Installations and the Management of Accumulators," \$2 by mail.

(5811) F. B. asks: 1. How can I find out if there is too much iron in a certain distilled water for good effects in all ordinary photographic processes? A. Test for iron with solution of iron ferrocyanide. 2. What is the approximate resistance, voltage, and amperage of a cell composed of a shallow copper pan 1 foot square x 1/4 inch high and zinc 1 foot square, zinc separated from copper by felt pad three-sixteenths inch thick, saturated with water and sulphate of copper, sulphate pulverized and in excess. A. The voltage would be about 1 volt. The resistance might be a few hundredths of an ohm at starting, but the cell would very quickly polarize in use from exhaustion of the solution and poor diffusion. 3. What is the smallest carbon, lowest voltage and amperage that will make sufficient arc illumination to equal a good oil light in an optical lantern for short distance, 5 to 8 feet circles. A. See the SCIENTIFIC AMERICAN, vol. 70, No. 3, page 38. Twenty or thirty volts and three or four amperes would be as good as an oil lamp, but still very unsatisfactory.

(5812) G. A. writes: 1. How can I convert the dynamo described in No. 600, SCIENTIFIC AMERICAN SUPPLEMENT, into a motor? A. No change is necessary—wind shunt and connect wires to suit the voltage at your disposal. As described it is suited for 50 volts. 2. How can I make the same smaller, say 1/2 horse power, using No. 18 magnet wire on armature and 16 on field magnet? A. Make about nine-tenths its present dimensions. 3. How many storage cells and what size will give me 1/2 horse power in said motor, the cells to be charged with 6 or 8 gravity battery? A. Allow five 35 ampere storage cells for 1/2 horse power. The recharging with gravity cells is not practicable. A minimum of 13 gravity cells is needed to charge, and these would be extremely slow. To run as a motor with five storage battery cells, substitute No. 8 wire for the wire given in the article.

(5813) J. B. A. asks: 1. Let me know a simple and efficient storage battery to be used in connection with a two horse power motor to run a 27 foot by 6 foot launch. A. We do not advise the construction at home of storage batteries. See our SUPPLEMENT, No. 845. For two horse power you must have about 1,500 watts; allow 4 amperes per square foot of positive plate, and base the number of cells on the voltage required. 2. Also please let me know a simple and efficient plunge battery, to be used for the same purpose. A. For a plunge battery see our SUPPLEMENT, No. 792. The size for a steam launch will be prohibitive. 3. Also, what size propeller and propeller shaft could I use on a 27 foot by 6 foot launch, to give the best results? A. Use a 24 inch propeller, 1 1/2 inch shaft. 4. Could I maintain a speed of about 10 miles an hour with a two horse power motor and proper size propeller? If not, what would be the best speed I could maintain? A. No. Possibly 5 miles per hour.

(5814) C. L. K. asks: 1. How many watts per candle power are required in the most economical incandescent lamp? Does it vary much in practice? A. Two and one-half watts, but this is at the sacrifice of durability of the lamp. It varies from this to 3 watts. 2. Is the number of volts and amperes required to heat the carbon fiber to incandescence determined empirically or theoretically, and how determined? A. It can be calculated, but the data for calculation are based on experiment. Practically speaking, it is determined empirically. 3. What books would give the best information on the above and allied subjects? A. Sloane's "Arithmetic of Electricity," \$1 by mail. Also Day's "Electric Light Arithmetic," price 50 cents.

(5815) C. J. M. writes: 1. Does a common copper and zinc and blue vitriol battery require an induction coil for the purpose of doing electrotyping on a small scale? A. No. The induction coil would prevent the proper action. 2. What is the best metal to have your wax matrix on for electrotyping, and how do you determine the direction the current runs? A. There is no best metal, practically speaking. For direction of



current test with two electrodes in the bath. 3. Is a single cell battery sufficient to do electrotyping at all? A. Yes. 4. What should be the respective sizes or weights of the metals in the battery? A. There is no fixed ratio. See SUPPLEMENT, No. 310, for details of electro-plating.

(5816) C. R. H. writes: I have a six candle power lamp which I would like to light for four hours each evening. 1. What kind of batteries should I use and how many? A. Use a secondary battery of 5 or 6 cells. 2. Would large size plunge battery described in "Experimental Science" do, or would it have to be replenished too often? A. It would require replenishing too frequently. 3. How long would plunge battery of same pattern run simple electric motor described in same book? A. It might run it for a couple of hours.

(5817) C. F. M. asks (1) how to make a spark coil? A. Make a bundle of pieces of iron wire, the whole one-half inch thick and eight inches long. Wind it with No. 22 wire to a total diameter of two inches. 2. How many batteries sal ammoniac will it take to light three burners? A. Two or three.

(5818) M. asks: Is there any way of communicating by the voice between places 250 feet apart, other than by a regular Bell telephone? Would a string telephone such as I have seen boys use answer for the purpose? And if so, how are they made? Will they work if the string rests on anything, or must it hang clear between the transmitters? A. An acoustic telephone can be used. Picture wire is good for the line, and for receiver and transmitter use parchment drum heads to whose center the wire is attached. The wire must touch no inflexible object. Lead it by loops of muslin around corners, etc., so as to keep a strong strain on it.

(5819) B. M. C. asks: 1. Is it true that the Bell telephone patent runs out January 30? A. See the SCIENTIFIC AMERICAN, February 3, 1894. 2. Is the Burnley dry battery suitable for running the Blake transmitter? A. Yes. 3. Is it any better or any cheaper to maintain than the Disque Leclanche battery? A. The cost of either is trivial, and one is about as good as the other for the purpose. 4. Would one cell of either battery operate the Blake transmitter one mile and a half? A. Yes. 5. Is a cipher called a figure? A. According to recent authority, the cipher 0 is not a figure.

(5820) J. A. B. asks: Does electricity travel on the surface of a wire, through the center of it, or is it equally distributed in every part of the wire? A. The current intensity for given conditions varies directly with the cross section of the wire. The best illustration of the action of the wire is to assume that it opens a path through the ether, a path in which there is no resistive medium for wave formation. As the transfer of electric energy involves no transfer of matter, and as electricity is not matter, we cannot directly answer your query. The best theory of the transfer of energy assumes that the ether surrounding the wire does the work. Electricity as such can only be stored on the surface of conductors.

(5821) C. G. W. asks: Is a copper wire woven (flexible) cable as good a conductor of electric current as a solid wire? A. Very nearly as good, if of the same aggregate cross sectional area. The bending of the wires would tend to increase the specific resistance of the copper.

(5822) H. asks: I wish to know if the common rubber belting would be a good and safe insulator between conductors carrying high power and the metal supports for the same. Cannot use covered wire, and the insulator must be flexible. If belting will not do, can you name an article of moderate cost that will answer the conditions? A. Rubber belting will be a very good insulator, especially if shellacked to prevent the accumulation of hygroscopic moisture. 2. What is the width of slot in cable subway? Is it sufficiently wide to allow the grip to be taken out at any point? A. About 3/4 inch, not enough to permit the grip to be removed.

(5823) G. L. H. asks: At what meridian does the day begin? A. The meridian at which the day changes is 180 degrees from Greenwich, England; from which place longitude for navigation is reckoned. The day meridian is an ocean line from just west of Behring Strait, passing east of New Zealand to the southern continent.

(5824) H. W. asks: What is the difficulty of the underground system of electric car traction? A. In securing good insulation. Water, dirt, ice, and snow work into the conduit and occasion great loss of current.

(5825) S. H. asks: Is there any method of determining the voltage of a magneto-electric battery? A. You can get at the average by a Cardew voltmeter or similar apparatus depending on the expansion of a metal by the heat produced by the current. The current is alternating and the voltage varies from zero upward.

(5826) T. R. asks how to construct a dry battery. A. For dry batteries we refer you to our SUPPLEMENT, Nos. 157, 767, and to the SCIENTIFIC AMERICAN, No. 2, vol. 67, and No. 7, vol. 68.

(5827) E. S. S. asks: 1. When I heat my soldering iron with natural gas through a Bunsen burner, a deposit is left by the flame, which of course has to be scraped off before the iron is used, causing great inconvenience. Can you tell me of any way I can prevent this deposit and still use gas? A. We can only suggest that you try a regular solderer's gas furnace, or use a brass tube kept hot by the flame and place the iron in it. It may be very thin and fit the iron closely. If surrounded by fire brick, giving about an inch space, you will get better heat. 2. What are the principal reasons that the electric cars cannot be supplied with current from below instead of from the overhead wire? A. Leakage of current owing to grounding caused by water, dirt, and condensed moisture. 3. What is the main point preventing economical use of the storage car system? A. The batteries are too heavy. 4. I have heard that in the human body there is some chemical that is worth nearly four hundred dollars an ounce. Can you tell me its name and the reason it cannot be extracted from a corpse? A. The metal calcium is quoted at \$310 an ounce. This is present in the cheapest materials also. 5. When two trolley cars are fed by the same wire and are both between the same feeders, why does not the

current all go through the car nearest the power house? A. This would be contrary to the law of branch circuits. The current follows all possible paths and is distributed in proportion to their respective resistances. 6. What is the reason that the block system on railroads is not more extensively used? A. It is very expensive. 7. I have the dynamo described in SUPPLEMENT, No. 161. With the H armature I get scarcely enough current to ring a bell. What should be the voltage and amperage of that dynamo, if properly constructed and run at the speed stated? Would a drum or laminated armature give any better result? A. It should give six or eight volts, and a laminated drum armature would give better results. See our SUPPLEMENT, No. 599. 8. Does not the number of ohms resistance of a piece of wire increase as the pressure and amount of current is increased? A. No. Your ninth query admits of no answer.

(5828) H. L. asks: 1. How many cells of Edison-Lalande battery, phonograph motor type, would be required to run the motor described in SUPPLEMENT, No. 759? A. Twenty cells should give good results. It would probably be better to wind it for lower resistance. 2. How many hours will it run with one charging? A. It gives 300 ampere hours. Dividing by 6 gives 50 hours. 3. How coupled? A. Couple according to the resistance of the motor, which is determined by the winding. 4. How many and what size cells of storage battery will it take? A. Three or four 35 ampere cells. 5. How many and what size cells Croft battery to charge the same? The motor to be used say 5 to 8 hours, and balance of time to be spent in charging. A. Eight in series and forty in parallel would charge 3 cells. 6. Which will be the least expensive to maintain, counting only the cost of materials used, not allowing for labor? A. Probably, all things considered, the Lalande-Edison battery would be the best and cheapest. 7. Have you a description of a storage battery that I could make myself? A. For a description of a storage battery see our SUPPLEMENT, Nos. 888 and 845. The diagram of connections you send is all right.

(5829) H. B. writes: Are there sufficiently correct surveys of Florida to enable you to determine whether artesian water could be had by boring at Tampa or not? Could a heater for a forty gallon water boiler be successfully constructed and operated from a 500 volt street railway current, and who could furnish such a heater? In a steam dry kiln for drying brick, at what intervals should a fan be capable of having removed or removing the cubic contents of the moist atmosphere in the kiln, or at what periods should it be removed in order to insure a proper state of atmosphere? Has colonization or missionary efforts done more for civilization? Is colonization induced by a Christian spirit or desire of pecuniary remuneration? Would a ball fired directly upward go a greater distance from the muzzle of the gun (on account of decreasing resistance of atmosphere, etc.) than if fired at 45 degrees? A. We have no record of artesian wells in the southern part of Florida, but from the well known slope of the water-bearing strata of the Cretaceous period, on the Atlantic border from New Jersey to Florida and along the Gulf and its supposed extension under the Atlantic Ocean and Gulf of Mexico out to the deep sea border, there can be but little doubt as to the flow of artesian wells up to or near the surface in all the northern and central parts of Florida. It may require considerable depth at Tampa, probably over 2,000 feet, to obtain a large quantity at a near surface flow, with also a possibility of a mineral characteristic, arising from its great distance from the source of supply, which are the uplands of Georgia. An electric heater can be made for the purpose described, but would be very expensive in cost of plant and for running. They are now used on a small scale by the Electric Heater Company, Havemeyer building, N. Y. The moist air in a drying kiln for brick should not be removed until the brick are thoroughly heated, so as to drive the moisture from the inside before the outside becomes dry enough to crack. The ventilation may then proceed to a degree not to lessen the temperature until there is no more evaporation or moisture arising from the brick. Fan blowers are not needed where natural draught for ventilation can be had. Intermittent ventilation as named is liable to make surface fracture and poor brick. Colonization has proved itself the great basis of civilization, and with few exceptions pecuniary gain has been the essential aim. A ball fired from a gun will rise higher on the vertical than at 45°.

(5830) Y. says: What is the composition of the bath to remove from engravings the water stains that they get from hanging on damp walls, and what length of time are the engravings left in the bath? A. Ozone can be used for removing mildew and other stains from engravings that have been injured by hanging on the walls of damp rooms. The engraving should be moistened and suspended in a large vessel. The ozone may be generated by putting pieces of clean phosphorus in the bottom of the vessel partially covered with water, or by passing electric sparks through the air in the vessel. Keep the engravings exposed to the ozone until thoroughly bleached. Phosphorus is very dangerous.

(5831) L. T. asks: 1. Are the stars commonly called second magnitude those between magnitudes 1 and 2, between 1.5 and 2.5, or between 2 and 3? A. The magnitudes of stars as generally designated are that all above 1 1/2 are designated as of first magnitude, and those between 1 1/2 and 2 1/2 as second magnitude and so on. Astronomers now designate the magnitudes by differences of one-tenth of a magnitude. 2. Suppose a person to be moving away from the earth at a speed faster than light travels. A says that to see the earth he must be looking toward it, B claims that he must be facing away from it. Which is right? If B is right, would he not see an inverted view of it, as if reflected from a mirror? A. A person moving away from a light faster than the velocity of light would see no light in either direction. 3. In a house heated by the hot water system, if all the radiators but one are shut off, will that one become hotter, or does the circulation of the water and consequent heat of the radiator depend only upon the rapidity with which the latter is cooled? A. The shutting off of all but one radiator would slightly increase the temperature of the water in the circulating radiator, due to the saving of heat radiated by the closed radiators.

INDEX OF INVENTIONS

For which Letters Patent of the United States were Granted February 13, 1894, AND EACH BEARING THAT DATE. [See note at end of list about copies of these patents.]

Table listing inventions with patent numbers, including: Adding machine, G. D. Strayer; Air compressor regulator, H. C. Sergeant; Air moistening apparatus, E. Kleiner; Alarm, See Burglar alarm; Animal gauge, T. O. Bennett; Annunciator, electric, I. E. Riskey; Annular, or C. P. Castersgood; Armature connection for dynamos, O. Dufault; Automatic brake, S. H. Cottrell; Axle, G. B. Hobbs; Axle, ball bearing, J. Bell; Axle making machine, W. Fletcher, Jr.; Bag, See Nose bag; Paper bag; Bag closure, J. Whittemore; Bag holder, folding, R. Matier; Bandolier, J. Bertrand; Barrel trussing machine, J. B. Stanhope; Barrel washer, M. Diehl; Battery cell, electric, P. C. Burns; Bearing, vertical shaft, A. C. Pessano; Bed, folding, M. J. Hafgar; Bed spring and slat holder, R. G. Melson; Beer on tap, apparatus for storing and preserving, C. Shabley; Bench, See Sizing bench; Bicycle, E. S. Starn; Bicycle, R. T. Starr; Bicycle change gear mechanism, A. L. Easingwood; Bicycle support, Davis & McGowan; Bicycle tool box, A. S. Carter; Blind window, Rasmussen & Johnson; Blower, centrifugal, J. O. Poole; Boat, A. D. Gomez; Boiler, See Smokeless boiler; Steam boiler; Boiler furnace, steam, B. Rober; Boilers, apparatus for supplying feedwater to; Bolt, See Nut locking bolt; Book, business instruction and practice, C. L. Ellis; Book, mileage, W. Boll; Boring frames to be cased, machine for, K. F. G.; Boring machine, B. D. Whitney; Boring mill, C. L. Libby; Bottle, nursing, E. H. Turner; Box, See Bicycle tool box; Paper box; Tobacco box; Brake for boring holes, etc., S. McClellan; Brake, See Automatic brake; Car brake; Vehicle brake; Brake for cycles or other wheeled vehicles, R. S. Eskine; Brick kiln, T. Green; Brick pressing machine, J. S. Pullan et al.; Bridge, E. W. Jessup; Bridge bit, R. Sears; Broiler or toaster, W. T. Russell; Brush for doors, fly, A. J. & A. J. Park, Jr.; Buckle, D. F. Dalton; Buckle, C. W. Stimson; Burlap carpet, A. J. Spurlock; Burlap carpet, pedestal, G. H. Hise; Buttons, holding device for cleaning uniform, E. A. J. Meredith; Cabinet work, J. Priest; Cannon air lock, W. C. Barr; Calculating apparatus, W. T. Odhner; Calipers or caliper, sliding, P. Reber; Can, See Tin can; Can forming and soldering machine, fruit, E. Eisenbraun; Can topping machine, C. A. Burt; Cant hook, W. L. Gatewood; Caps, E. K. Mowatt; Car and air brake coupling, combined, G. R. J. Newman; Car bolster, C. T. Westlake; Car brake, J. Kirwin; Car brake handle, J. Marrisett; Car coupling, Brooks & McDonough; Car coupling, H. H. Merril; Car coupling, M. H. Merril; Car dump, H. P. Williams; Car dumping device, hydraulic, N. H. Pine; Car gate attachment, railway, H. Tesseyman; Car, hand, C. Benesh; Car, hand, C. Roberts; Car, hand, street, T. Euphrat; Car, railway, J. Timms; Car replacer, A. S. Debose; Cars, electrically operated street indicator for, H. C. Barker; Cars, temperature regulator for fruit, J. F. McElroy; Carpet stretcher and tacker, G. W. Kelley; Carriage body, G. J. Saubrey; Carriage foot rail, F. Van Patten; Carriage wheel, O. Finnigan; Cartridge implement, N. G. Hanson; Cartridge reloading implement, W. Mason; Cartridge, reloading, W. G. Smith; Cartridge stop for rimless cartridges, M. H. Durst; Cash register, G. W. Grove; Cash register, C. Smyth; Cash register and indicator, J. P. Clea; Cast, electric, H. C. Lawler; Caster, E. J. Washbord; Caster, furniture, G. J. Bowley; Catamenial sack, E. Kirwin; Chain, drive, A. Ritscher; Chair, See Folding chair; Chair and step ladder, combined, W. H. White; Chain, roller, W. G. Smith; Chenille fabric, woven, L. Binns; Churn, G. Laube; Churn motor, B. J. Campbell; Churn operating mechanism, C. C. Warren; Cider press, E. M. Lantz; Cigar lighter, electric, A. J. Gray; Cigar tip cutter and lighter, W. E. Duthie; Cigarettes, machine for the manufacture of non-pasted tubes for, A. E. Decouffe; Clamp, See Locking clamp; Clay mixer and feeder, M. F. Williams; Cleaner, See Grain cleaner; Clock, electric, Benjamin H. Campche; Clock box, stop, N. C. Sund; Cock or faucet, self-closing, T. Bonroe; Coffee making apparatus, B. F. Gage; Coffee roaster, Jones & Little; Coin controlled apparatus, G. F. W. Schultze; Coking furnace, N. K. H. Ekelund; Coking retort, device for holding, Peiner & Saxton; Compartment vessel or holder, L. A. Moore; Cordage machines, adjustable take-up for, C. N. Brown; Corn shelling and grinding machine, combined, T. Kniffer; Cotton gin, roller, Stapleton & Ray; Coupling, See Car coupling; Car and air brake coupling; Hose coupling; Pipe coupling; Sewer pipe coupling; Thill coupling; Curtain fixture, Miller & Oldfield; Curtain pole ring, C. W. Lawrence; Cutter, See Claw tip cutter; Gore cutter; Stalk cutter; Thread cutter; Cutter guard, F. H. Warren; Damper regulator, A. Catchpole; Damper regulator, automatic, S. M. Gaston; Davit, boat's, A. R. Paul; Decorticating ramie, machine for, C. Philibert et al.; Dehorning shears, F. H. Aditt; Dental mandrel, W. S. Elliott; Dimethylpiperazine, C. Stoehr; Door check, R. B. Carter; Door check, R. B. Carter; Door check, N. G. Sorenson; Drain, J. L. Steltz; Dredger, S. P. Hedges; Dredger, steam vacuum, E. D. Harsen; Dredging bucket, T. Symonds; Dredging cocoa, etc., J. G. Elizondo; Dry kiln, W. A. Leary; Drying cylinder or drum, W. G. Mackinney; Drill, See Grain drill; Track drill; Driving gear, A. B. Roney; Dwelling, G. T. Tilden; Dye, diazo dark green, Hoffmann & Daimler; Dyeing apparatus, L. Weldon; Earing, See Earplugs; Electric alarm, S. T. Sanders;

Table listing inventions with patent numbers, including: Electric cable, T. Guilleaume; Electric circuits, apparatus for periodically completing and interrupting, Berry & Harrison; Electric circuits, magazine fuse for, C. E. Jones; Electric conductors, bond wire for, Hoffmann & Brown; Electric lock, R. V. Cheatnam; Electric machines, current regulator for dynamo, C. E. Scribner; Electrical apparatus, G. W. Hey; Electrical conductor, D. E. Hayward; Electricity, apparatus for testing the resistance of conductors of, E. G. Willyoung; Electrolytic cell, E. A. Le Sneur; Elevator, See Water elevator; Elevator and dump, E. E. Barton; Engine, See Gas engine; Steam engine; Engine reversing gear, steam, A. R. Lamb; Fabric for ventilated packages, W. H. Wright; Feedwater heater and purifier, J. G. Cooper; Fence post, D. W. Sigler; Fence wire fastening device, F. H. Knapp; Fencing, machine for making wire, J. D. Curtis; Fencing, machine, J. D. Curtis; Filter, D. Williamson; Fire escape, S. Cook; Fire escape, Wood & Ross; Fire extinguisher, Aldrich & Hall; Fire extinguisher, automatic, A. D. Linn; Fire extinguishing apparatus, automatic, N. Leonard; Fire extinguishing systems, valve for, G. Mills; Firearm, breech-loading, J. L. McCullough; Firearm, electrical, J. L. McCullough; Fish, curing and drying, T. S. Whitman; Flatiron rest or holder, W. W. Nugent; Flatiron rest or holder, A. A. Sawyer; Flower, artificial, A. Mayer-Schlowen; Fl ex pander and beader, J. Col es.; Folding chair, J. Cornell; Folding gate, W. R. Pitt; Founding, H. B. A. Kelsner; Furnace, See Boiler furnace; Coking furnace; Muffle furnace; Game apparatus, N. O. Starks; Game apparatus, P. Thamerus; Garbage receptacle, D. Daniels; Garment hook, R. Ahlers; Gas, apparatus for administering nitrous oxide, W. Smithard; Gas engine, C. H. Hisey; Gas mixer, D. P. Strik; Gate, See Folding gate; Railway gate; Gate, M. Alston; Gate, M. L. Rison; Glass tank furnaces, hood or muffler for, W. F. M. Jones; Gopher exterminator, G. Laube; Gore cutter and marker, E. E. Dalley; Governor, speed, W. H. Von Mengerhausen; Grain cleaner, J. C. Ross, Jr.; Grain drill, H. L. Whitman; Gridiron or broiler, E. A. & M. Benedict; Grinding machine, caps, J. C. Chapin; Grip mechanism, friction, E. Stanciffl; Gun barrel cleaning implement, C. M. Stafford; Gun, breakdown, J. Tonks; Guns, ejector for breakdown, W. H. Davenport; Hammer, H. Wagner; Hane and cockeye, J. B. Palmiter; Hammer, railway, G. W. Laird; Hammer, steam, J. Beche, Jr.; Hammock support, H. Wagner, Jr.; Hanger, See Baves trough hanger; Harness attachment, Griesemer & Manger; Harrow tooth fastener, E. A. Ovenshire; Hay, E. W. Jones; Hay sling, W. Gutenkunst; Hay stacker and loader, M. R. Jenkins; Heater, See Feedwater heater; Heating device, hot water, M. F. Bishop; Heel nailing machine, Jack, S. A. Krewson; Helicopter, L. V. Allingham; Hinges, G. Laube; Hook, See Cant hook; Garment hook; Horseshoe, C. C. Jerome; Hose coupling, J. J. Barrett; Hub attaching device, C. M. Graves; Hub, wheel, King & Dunn; Indicator, See Speed indicator; Station indicator; Influence machine, H. F. Waite; Insulating joint, E. F. Gennert; Iron, See Sagg iron; Jack, See Heel nailing machine jack; Lifting jack; Journal bearing, axle, J. P. Metzger; Journal boxes, device for adjusting, J. A. Sanford; Kiln, See Brick kiln; Dry kiln; Kitchen cabinet, C. Bouchard; Knitting machine dial cap, F. B. Wildman; Labeling machine, E. W. Cornell; Ladder, sliding, W. J. Thurman; Lamp, electric arc, C. E. Scribner; Lamp, electric arc, Scribner & Warner; Lamp, electric arc, J. E. Woolvorton; Lamp, incandescent electric, Timbrell & Fyfe; Lamp, incandescent, Bergman; Lamp trimmer and regulator, A. W. Robinson; Lamps, device for heating water over alcohol, M. F. Bishop; Lands from overflow device for protecting riparian, W. & H. McCaughan; Lantern, magic, G. E. & V. H. Emerson; Letter printing machine, J. A. Safford; Letter, transparent, De Borman; Life preserver, P. Hohmann; Lifting jack, W. Johnson; Link lifter, L. West; Lock, See Electric lock; Locking ramp, J. C. Platt; Log loader and turner, W. E. Hill; Log loader and turner, steam, W. E. Hill; Logging car, W. Sasse; Loom selvage forming apparatus, Ashworth & Oldham; Loom temple, R. P. Pearson; Lounge, H. K. Reiser; Measuring instrument, electrical, Garver & Willyoung; Measuring instrument, electrical, E. G. Willyoung; Measuring instrument, electrical, Willyoung & Garver; Measuring machine, leather, J. E. Robinson; Measuring water from lakes, etc., machine for, W. T. Lambie; Mechanical movement, F. Meisel; Mechanical movement, V. Tomasa; Milker, cow, N. W. & A. H. Hussey; Mill, See Boring mill; Grinding mill; Windmill; Minnow bucket, J. M. Kersey; Motor, See Churn motor; Vapor motor; Muffle furnace, A. A. Breneman; Music box attachment, clock, C. H. Jacot; Music stand, F. Hinkle; Musical bag instrument, J. S. Back; Nitro compound and making same, R. C. Schupp; Nose bag, A. H. Hanson; Nut lock, W. H. Harris; Nut lock, King & Dunn; Nut locking bolt, C. Stanniffl; Ore separator, E. F. Lacon; Oven, D. C. Green; Oven, bake, P. Walter; Paddle for propelling small boats, M. McCloskey; Paper bag, J. M. Guilbert; Paper box, S. E. Patrick; Paper carriers, letter for, W. H. Waldron; Paper pulp strainer, M. M. Sloan; Pattern for draughting garments, adjustable, H. Horn; Perforator, J. T. Scott; Photographic embossing press, D. D. McKee; Planer feed mechanism, A. W. Hall; Pianoforte pedal attachment, P. Mueller; Pipe connection, metal, P. J. McGuire; Pipe coupling, C. Shields; Pipe cutting machine, J. B. Waring; Pipe wrench, chain, C. L. Mahnicko; Piston head, steam engine, C. O. Heggen; Planer feed mechanism, metal, W. Gleason; Planter, corn and cotton, H. Pieper; Planters, wireless check row attachment for corn, W. J. Taylor; Plow, C. A. Johnson; Point and switch, J. E. Billups; Polishing machine, M. D. Wayman; Pot chain and scraper, combined, N. R. Streeter; Power, electrical transmission of, C. S. Bradley; Press, See Cider press; Photographic embossing press; Signature press; Pressure gauge electric alarm, W. H. Bradt; Printer's galley, E. Lau; Printing machine, web perfecting, Meisel & Chapin; Printing press, paper dampening device, E. P. Albe; Propelling boats, footpower for, Bold & Oldham; Pulley, differential, E. D. Gleason; Pulp from liquids, machine for separating, Seiler & Emig; Pump, air, J. Dickens;

**Pump, hydraulic air, E. H. Weatherhead.** 514,608  
**Pumping and compressing air, apparatus for, C. W. & B. A. Buerkle, Jr.** 514,880  
**Pumping fluids, suction and force apparatus for, W. M. Morgan.** 514,659  
**Push bar plate, D. L. Barnes.** 514,638  
**Railway conduit, electric, R. I. Hampton.** 514,527  
**Railway crossing signal, electric, M. J. O'Sullivan.** 514,561  
**Railway electric, P. W. Laffer.** 514,630  
**Railway frog, Stewart & Wedge.** 514,735  
**Railway gate, automatic, G. D. Warren.** 514,756  
**Railway platform, T. Kennedy.** 514,665  
**Railway pole, electric, E. W. Serrell.** 514,716  
**Railway rail, joint, splice and brace, M. Martin.** 514,832  
**Railway switch, D. M. Church (r).** 11,404  
**Railway switch, electric, W. M. & W. C. Henderson.** 514,850  
**Railway system, electric, P. W. Laffer.** 514,718  
**Railway tie plate, J. A. Harris.** 514,523  
**Railway tie plate, W. W. Holmes.** 514,465  
**Railway tie plate, and making same, W. W. Holmes.** 514,467  
**Raisin seeding machine, C. W. Thompson.** 514,689  
**Reflectors, making, W. W. Pilkington.** 514,495  
**Refrigerator, Gurney & Medberry.** 514,586  
**Register. See Cash register.**  
**Regulator. See Damper regulator.**  
**Respiration, apparatus for producing artificial, W. F. Z. Desant.** 514,448  
**Revolver, G. P. Blow.** 514,636  
**Ring. See Curtain pole ring.**  
**Roam cleaning machine, pneumatic, J. J. Astor.** 514,805  
**Roadster. See Coffee roaster.**  
**Rod or lat machine, D. Hepp.** 514,750  
**Rolling mill guide, P. L. Day.** 514,447  
**Running gear, A. H. Sensenig.** 514,507  
**Sad iron, steam, J. Mandot.** 514,901  
**Sash fastener, W. A. Zietzke.** 514,532  
**Sash, revolving window, F. S. Riddelle.** 514,773  
**Satchel or bag frame, F. E. Hillmann.** 514,457  
**Scale, price, L. F. Kepler.** 514,475  
**Scales, calculating attachment for weighing, E. B. Johnson.** 514,471  
**Scraper, W. Davey.** 514,645  
**Screen. See Window screen.**  
**Screw machine, automatic, P. Briggs.** 514,441  
**Scythe blades, mechanism for making, G. Eiserle.** 514,545  
**Seal, B. J. Sturtevant.** 514,786  
**Seam ripper, G. H. Carder.** 514,811  
**Seat and seesaw, combined, E. Tornblom.** 514,521  
**Separator. See Ore separator.**  
**Sewer pipe coupling, J. D. Anderson.** 514,492  
**Sewing bench, book, F. Adams.** 514,671  
**Sewing machine binder attachment, M. Riker.** 514,806  
**Sewing machine, fur, F. Van Cauwenbergh.** 514,874  
**Sewing machine, glove, F. Van Cauwenbergh.** 514,635  
**Sewing machine looper, J. Heberling.** 514,653  
**Sewing machine quilting attachment, W. A. Cassidy.** 514,448  
**Shears. See Animal shears; Dehorning shears.**  
**Sheep shearing machine, D. S. Chambers.** 514,704  
**Ships, apparatus for moving and steering steam, G. Wauters.** 514,527  
**Shirt waist, J. Macgowan.** 514,720  
**Shoulder brace, F. E. Matthews.** 514,834  
**Soaker, revolving window, F. E. Hillmann.** 514,515  
**Shuttle and needle operating mechanism, V. Tomsa.** 514,792  
**Sifter, revolvable ash, F. Maul.** 514,764  
**Signal. See Railway crossing signal.**  
**Signal apparatus, electrical, G. W. Hey.** 514,461  
**Signal switch, pneumatic, J. Schnepp.** 514,503  
**Signature, C. Seybold.** 514,732  
**Siphon, G. Seifert.** 514,733  
**Skirt extender, G. W. Lockwood.** 514,861  
**Sleigh nose, A. Hurtabise.** 514,469  
**Slubbing and roving machines. Means for driving, Ashton & Moorhouse.** 514,693  
**Smoke combuster, T. Gunning.** 514,857  
**Smokeless boiler, W. S. Plummer.** 514,859  
**Snow melting apparatus, G. T. McCormick.** 514,682  
**Speed indicator, J. Naylor, Jr.** 514,865  
**Spooling machine, J. W. Foster.** 514,884  
**Spring. See Bolster spring.**  
**Stalk cutter, roller, and seed planter, combined, G. W. Tucker.** 514,522  
**Stand. See Music stand.**  
**Staple holder, W. J. Brown.** 514,699  
**Station indicator, E. Elbert.** 514,639  
**Steam, apparatus for eliminating lubricant from exhaust, J. H. Blessing.** 514,440  
**Steam, apparatus for recovering lubricant from exhaust, J. H. Blessing.** 514,438  
**Steam boiler, G. H. Taylor.** 514,841  
**Steam engine, A. G. Brown.** 514,700, 514,701  
**Steam engine, twin screw, H. Friedeborn.** 514,650  
**Steam separator for removing lubricant from exhaust, J. H. Blessing.** 514,439  
**Steam trap, J. H. Blessing.** 514,833  
**Stilt, W. A. Johnson.** 514,600  
**Stove hot water generator, A. Saunders.** 514,732  
**Stove, oil, J. Kells.** 514,555  
**Stovepipe joint, extension, G. Laube.** 514,897  
**Strainer, milk, H. W. Diers.** 514,646  
**Street sweeper, R. F. Furnas.** 514,676  
**Street sweeper, J. B. Marz.** 514,658  
**Surgical ligature preparation and inclosure, R. Kny.** 514,568  
**Switch. See Railway switch; Signal switch.**  
**Switch operating mechanism, C. C. Lott.** 514,759  
**Sword belt and hanger, L. H. Allen.** 514,804  
**Table or chair legs, shoe for bent wire, J. F. Wilmot.** 514,744  
**Tablet or manuscript holder, writing, B. W. Scott.** 514,777  
**Tanning apparatus, W. T. Harrison.** 514,549  
**Telegraph signal safety attachment, C. W. Babbitt.** 514,745  
**Telephone, C. T. Bloomer.** 514,636  
**Telephone signaling system, W. Gillette.** 514,829  
**Vent, J. W. Ormsby.** 514,726  
**Thill coupling, J. S. Patten.** 514,493  
**Thill coupling, C. W. Smith.** 514,510  
**Thread cutter, J. R. Weir.** 514,529  
**Tie. See Umbrella tie.**  
**Timber compressing and curing machine, H. L. Du Bois.** 514,847  
**Tin can, C. W. Whitcomb.** 514,688  
**Tire, pneumatic, F. A. Wegner.** 514,796  
**Tobacco box, C. E. Speaker.** 514,512  
**Torpedo launching tube, J. B. G. A. Canet.** 514,810  
**Toy, H. C. Fuller.** 514,620  
**Toy bowling alley, T. Danquard.** 514,673  
**Trace fastener, H. F. Perry.** 514,773  
**Track drill, J. Creclius.** 514,544  
**Trap. See Steam trap.**  
**Trimmer. See Lamp trimmer.**  
**Trolley, J. A. Williams.** 514,801  
**Trousers, Walther & Street.** 514,576  
**Truck, car, C. Thompson.** 514,573  
**Truck, hand, F. E. Marz.** 514,836  
**Trunk, wardrobe, R. Alfeld.** 514,585  
**Tug, thill, S. H. Haas.** 514,468  
**Type writing machine, W. J. Barron.** 514,807  
**Type writing machine, J. D. Daugherty.** 514,846  
**Type writing machine, C. F. Taylor.** 514,517  
**Umbrella tie and name plate, combined, W. E. Murbarger.** 514,595  
**Umbrellas, etc., tip for, A. T. Laube.** 514,853  
**Unicycle, F. H. Armistead.** 514,612  
**Valve gear, J. Spencer.** 514,733  
**Valve seating tool, H. D. Sabin.** 514,887  
**Valve, steam engine, W. G. Shepherd.** 514,509  
**Vapor motor, ether, P. de Suiset.** 514,573  
**Vaporizer and burner, oil, E. B. Raymond.** 514,870  
**Vehicle brake, Davidson & Lock.** 514,446  
**Vehicle gearing, G. F. Thomson.** 514,892  
**Vehicle starter or brake, H. Carmont.** 514,812  
**Vehicle wheel, A. L. Schmidt.** 514,502  
**Vehicle wheel, child's, G. Laube.** 514,855  
**Velocipede pedal, T. Warwick.** 514,742  
**Velocipede, railway, J. Donovan.** 514,449  
**Velocipede saddle, W. L. Decker.** 514,748  
**Vessels, etc., body of least resistance for, F. E. Mills.** 514,835  
**Vise, T. M. Brintnall.** 514,614  
**Warping or other machines, come holder for, J. W. Foster.** 514,885  
**Washer. See Barrel washer.**  
**Washing machine, T. P. Butterfield.** 514,703  
**Washing machine, G. Laube.** 514,890  
**Waste apparatus for bath tubs, basins, etc., J. Farrell.** 514,675  
**Watch bow pliers, H. W. Wuidt.** 514,730  
**Watch case centers, making dies for, F. Ecaubert.** 514,648  
**Water elevator, G. W. Campbell.** 514,616  
**Water purifier, E. J. M. Clemens.** 514,617  
**Wheel. See Carriage wheel; Vehicle wheel.**  
**Wind gauge sight, W. Lyman.** 514,562  
**Windmill, F. W. Eaton.** 514,848  
**Winding machine tube holder, thread, J. W. Foster.** 514,886  
**Window scaffold, adjustable, W. W. Hills.** 514,464  
**Window screen, H. Higgin.** 514,654  
**Window screen, W. Scott.** 514,371  
**Wire and slat fabric weaving machine, W. C. Fratt.** 514,496  
**Wire, making, M. H. Jones.** 514,768  
**Wire twister, J. W. Alverson.** 515,692  
**Wood carving machine, Saunders & Story.** 514,731  
**Wood working machine, W. T. Smith.** 514,607  
**Wrench. See Pipe wrench.**  
**Wrench, W. H. Haire.** 514,459  
**Wrench, E. A. Humphrey.** 514,452  
**Wrench, J. A. Gray.** 514,477  
**Wrench, F. S. Seymour.** 514,781  
**Writing packet and copy holder, combined, G. G. & E. S. Burton.** 514,541

**DESIGNS.**  
**Badge heading, Torsch & Lee.** 23,058  
**Book mark, L. L. Huestis.** 23,090  
**Building block, J. A. Merley.** 23,063  
**Chair, A. Thonet.** 23,065  
**Chair, student, E. E. Peck.** 23,066  
**Halter loop, J. N. Bull.** 23,064  
**Match box, W. G. Walker.** 23,061  
**Mosaic pattern, W. G. H. Felt.** 23,063  
**Picture frame, W. C. Strickler.** 23,072  
**Post hole digger, L. Gibbs.** 23,072  
**Rug, A. M. Rose.** 23,056  
**Spoons, etc., handle for, J. W. Maillet.** 23,057  
**Sad iron, H. F. Carver.** 23,067  
**Scraper for kitchen utensils, W. I. Leggett.** 23,069  
**Stove, E. D. Nellis.** 23,071  
**Stove base, cooking, F. W. Osborne.** 23,069  
**Woven fabric, J. H. Chadwick.** 23,055

**TRADE MARKS.**  
**Balsam, F. Mayerhofer.** 24,227  
**Barley and malt extracts and carbonated beverages, J. A. W. Fernow.** 24,228  
**Billiard table cushions made of rubber compound, Brunswick-Balke-Collender Company.** 24,237  
**Boots and shoes, leather, R. B. Grover & Co.** 24,204  
**Brandy, cherry, P. N. Heering.** 24,224  
**Butter, Elgin Butter Company.** 24,217  
**Canned fruits and vegetables, Bloomington Canning Company.** 24,214  
**Coffee, roasted, E. J. Gillies & Co.** 24,220  
**Cotton goods, Coventry Company.** 24,209  
**Diuretics, G. Fournier.** 24,229  
**Dress shields, Canfield Rubber Company.** 24,208  
**Fish nets, Harbour Bros. Company.** 24,212  
**Goods, certain named dress, Abraham & Straus.** 24,211  
**Goods for men, certain named furnishing, Oppenheimer, Straus & Co.** 24,207  
**Grinding feed mills, J. C. Woodcock.** 24,241  
**Hams, beef, and tongues, cured, J. H. Michener & Co.** 24,216  
**Iron derivatives of albumen, C. F. Boehringer & Soehne.** 24,228  
**Jelly compound for table relishes, Stern & Saalberg.** 24,218  
**Lamps, Snell Cycle Fittings Company.** 24,238  
**Medicinal compound for external and internal use, liquid, G. S. Cheney.** 24,234  
**Medicine for certain named diseases, A. A. Shuland.** 24,232  
**Medicine for the cure of eczema, G. W. Rankin.** 24,235  
**Milk, condensed or preserved, Orange County Milk Association.** 24,219  
**Mineral water, ginger champagne, and ginger ale, natural, Manitou Mineral Water Company.** 24,222  
**Night robes, B. Rosenfeld & Co.** 24,202  
**Paints, certain named, J. L. Jones.** 24,203  
**Perfumery, C. L. Cotton Perfume and Extract Company.** 24,225  
**Plants and seeds, "Lathyrus" Landwirtschaftliche Gesellschaft mit Beschränkter Haftung.** 24,213  
**Remedies, certain named, J. O. Ducker et al.** 24,233  
**Remedies for eczema, A. L. Jones.** 24,231  
**Remedy for chills and fever, W. F. Morrow.** 24,231  
**Retinned steel ware for kitchen use, Bellaire Stamping Company.** 24,239  
**Skins, calf and goat, Guignies Tanneries Company.** 24,206  
**Soap, petroleum, M. Jenkins.** 24,226  
**Staves and heading, J. H. Hamlen & Son.** 24,240  
**Steam traps, Estate of A. L. Jones.** 24,242  
**Sweet potato flour, bread and pastry made therefrom, and desiccated and sliced sweet potatoes, E. Straus.** 24,215  
**Tea, Remington Johnson Company.** 24,221  
**Veterinary remedies, P. S. Buckley.** 24,236

A printed copy of the specification and drawing of any patent in the foregoing list, or any patent in print issued since 1863, will be furnished from this office for 25 cents. In order to please state the name and number of the patent desired, and remit to Munn & Co., 361 Broadway, New York.

Canadian patents may now be obtained by the inventors for any of the inventions named in the foregoing list, provided they are simple, at a cost of \$40 each. If complicated the cost will be a little more. For full instructions address Munn & Co., 361 Broadway, New York. Other foreign patents may also be obtained.

**Advertisements.**

**ORDINARY RATES.**  
**Inside Page, each insertion - - 75 cents a line**  
**Back Page, each insertion - - - \$1.00 a line**  
 For some classes of Advertisements, Special and Higher rates are required.  
 The above are charges per agate line—about eight words per line. This notice shows the width of the line, and is set in agate type. Engravings may head advertisements at the same rate per agate line, by measurement, as the letter press. Advertisements must be received at Publication Office as early as Thursday morning to appear in the following week's issue.

**Patent Foot Power Machinery.**  
**Complete Outfits.**  
 Wood or Metal workers without steam power can successfully compete with the large shops by using our New **LABOR SAVING Machinery**, latest and most improved for practical shop use, also for Industrial Schools, Home Training, etc. Catalogue free.  
**Seneca Falls Mfg. Co.**  
 635 Water Street, Seneca Falls N. Y.

**WILSON IMPROVED IRON PLANERS**  
 STANDARD SIZES W. A. WILSON  
 KEPT IN STOCK. RIVER ST. ROCHESTER, N. Y.

**Parsons Horological Institute.**  
**Learn the Watch Trade**  
 Engraving and Jewelry Work.  
**PARSONS, IDE & CO.** Circular free.  
 302 Bradley Ave., PEORIA, ILL.

**EDGE TOOLS**  
 are often nearly ruined by using a grindstone not adapted to the work. Our quarries produce a large variety of grits suitable for grinding any tool.  
 May we send you our Catalogue, which will give you some information?  
**GRAFTON STONE COMPANY,**  
 No. 80 River Street, GRAFTON, OHIO.

**LATHES.** Shapers, Planers, Drills, Machine Shop Outfits, Foot Lathes, Tools and Supplies. Catalogue Free. **SEBASTIAN LATHE CO.,** 120 CULBERT ST., CINCINNATI, O.

**MAKE YOURSELF A MECHANICAL ENGINEER OR DRAUGHTSMAN;**  
 Or qualify to take charge of or to superintend the manufacture of machinery, by devoting your idle hours to Home Study by the method of **THE CORRESPONDENCE SCHOOL OF MECHANICS.** Scranton, Pa. To begin, students need only know how to read and write. Moderate charges. Send for FREE Circular.

**NEPERA CHEMICAL COMPANY.**  
**NEPERA PAPER.**  
 A New Printing-Out Ready Sensitized Paper.  
**PERMANENT PRINTS, Better Results, Easier Obtained. No Ice, No Hot Water Treatment, No Lens, Salt, or Alum or other hardeners endangering the durability of the image. Extreme simplicity of all operations. Printed, mounted and mounted in less time and with less trouble than any other paper. Does not brown and does not fix out. Can be treated alike in summer as in winter. Has none of the defects of its rivals.**  
 For Sale by All Dealers.  
**Nepera Chemical Co., Nepera Park, N. Y.**

**IMPROVED CHARTER GAS ENGINES.**  
 USING KEROSENE GASOLINE OR FRODOGAS  
 GASOLINE NATURAL GAS  
 RELIABLE SAFE ECONOMICAL SIMPLE  
 DELICATE NO PARTS  
**H. W. CALDWELL & SON**  
 SOLE MFRS  
 WASHINGTON & UNION STS. CHICAGO, ILLS.

**ICE-BOATS—THEIR CONSTRUCTION and Management.** With working drawings, details, and directions in full. Four engravings, showing mode of construction. Views of the two fastest ice-sailing boats used on the Hudson river in winter. By H. A. Horsfall, M. E. Contained in **SCIENTIFIC AMERICAN SUPPLEMENT, 1.** The same number also contains the rules and regulations for the formation of ice-boat clubs, the sailing and management of ice-boats. Price 10 cents.

**Every Man His Own \$3 PRESS, Printer.**  
 for printing Cards and Labels.  
 Circular Press, \$3.  
 Small Newspaper Press, \$4.  
 Printed instructions for using. Catalogue free.  
**KELSEY & CO., Makers, Meriden, Conn.**

**CONSULTATION INVENTORS.**  
 AND ADVICE TO Experimental work of every description. Automatic machines designed and built. Send for circular.  
**MALTBY MFG. CO., Brooklyn, N. Y.**

**"OTTO" GAS AND GASOLINE ENGINES.**  
 1/2 to 100 h. p. Can be used in cities or in country independent of gas works or gas machines.  
 No Boiler, No Danger, No Engineer.  
**OTTO GAS ENGINE WORKS, PHILADELPHIA.**

**BUY TELEPHONES**  
 That are good—not "cheap things." The difference in cost is little. We guarantee our apparatus and guarantee our customers against loss by patent suits. Our guarantee and instruments are **BOTH GOOD.**  
**WESTERN TELEPHONE CONSTRUCTION CO.,**  
 440 Monadnock Block, CHICAGO.  
 Largest Manufacturers of Telephones in the United States.

**Shingle, Heading, and Stave Mill Machinery**  
 and Veneer Cutting. Send for Cat. A.  
 Handle Machinery for Turning Handles for Brooms, Axes, etc. Send for Cat. B.  
 Wood Pulp Machinery. Send for Cat. C.  
**Trevor Mfg. Co.**  
 Lockport, N. Y.

**MANUFACTURE TO ORDER SPECIALTIES & NOVELTIES—PATENTED ARTICLES—SMALL OR FINE MACHINERY.**  
 SEND FOR CATALOGUE  
**OTTO KONGIGLOW**  
 49 MICHIGAN ST. CLEVELAND, O.

**Stereopticons**  
**Lantern Slides - -**  
 This Season's Specialty.  
 World's Fair Lantern Slides.  
 Write for Catalogue M.  
**MCINTOSH BATTERY & OPTICAL CO., Chicago.**

**IF YOU HAVE ANY SMALL ARTICLES**  
 in Brass or Iron that you want manufactured in quantities, write to **THE JONES BROS. ELECTRIC CO.,** 28-30-32 West Court St., Cin'ti, O.

**WORLD'S FAIR HIGHEST AWARDS**  
 Medal & Diploma on our INCUBATOR and BROODER combined.  
 Medal on Hot Water Brooder.  
 Old "Reliable" Leads Them All.  
 If you are interested in Poultry, it will pay you to send 4c. in stamps for our 72-p. cat., giving valuable points on poultry culture.  
**Reliable Incubator & Brooder Co., Quincy, Ill.**

**THE MODERN ICE YACHT.—BY** Geo. W. Polk. A new and valuable paper, containing full, practical directions and specifications for the construction of the fastest and best kinds of Ice Yachts of the latest, most approved forms. Illustrated with engravings drawn to scale, showing the form, position, and arrangement of all the parts. Contained in **SCIENTIFIC AMERICAN SUPPLEMENT, No. 624.** Price 10 cents. To be had at this office and of all newsdealers.

**STEVENS PATENT FINE ADJUSTING AND TRANSFER INSIDE CALIPER, No. 105.**  
 Price List, by mail, postpaid.  
 6 inch.....\$1.50 10 inch.....\$2.00  
 8 ".....1.75 12 ".....2.25  
 Ideal and Leader Spring Calipers and Dividers, Ideal Surface Gauges, Depth Gauge, and Fine Machinists' Tools.  
 Illustrated catalogue free to all.  
**J. STEVENS ARMS & TOOL CO.**  
 P. O. Box 280, Chicopee Falls, Mass.

**D'AMOUR & LITLEDIALE, MACHINISTS AND TOOL MAKERS,**  
 204-206 East 43d St., New York.  
 Drawings, Patterns, Models, and Experimental Work.  
**THE LINK-BELT COMPANIES,**  
 PHILADELPHIA, NEW YORK, CHICAGO.  
 Originators of the best practice in the use of Link-Belt of standard designs.  
 Ewart Link-Belt (31 regular sizes).  
 Sprocket Wheels, Rope Transmissions, Fibre-Graphite Self-Lubricant Journal Bearings.  
 Machinery for elevating and conveying any material.  
 Philadelphia address, 2020 Hunting Park Av.

**VANDUZEN STEAM PUMP**  
 THE BEST IN THE WORLD.  
 Pumps Any Kind of Liquid.  
 Always in Order, never Clogs nor freezes. Every Pump Guaranteed.  
**10 SIZES.**  
 200 to 12000 Gallons per Hour.  
 Cost \$7 to \$75 each. Address  
**THE VANDUZEN & TIFT CO.,**  
 102 to 108 E. Second St., Cincinnati, O.

**Rubber Rolls and Wheels.**  
 Power Wringing Machines, Drying and Ventilating Fans. All styles of Trucks made to order. Catalogue free.  
**GEORGE P. CLARK,**  
 Box 1, Windsor Locks, Conn.

**The McCONNELL Germ Proof Filters**  
**REMOVE MICROBES**  
 —AND—  
 All Kinds of Disease Germs.  
 Is a Filter and Cooler Combined.  
 The ice as it melts is filtered.  
 No other gravity filter does this.  
**The McConnell Filter Co.,**  
 BUFFALO, N. Y.

**MECHANICAL SCIENCE.—PRESIDENTIAL address before Section G of the British Association, by J. Head, M. Inst. C. E. An interesting paper showing the mechanical science is largely indebted to mechanisms as they exist in nature, if not for its own origin, at all events for much of its progress hitherto, and that nature must still be our guide. Contained in **SCIENTIFIC AMERICAN SUPPLEMENT, No. 936.** Price 10 cents. To be had at this office and from all newsdealers.**

**FOOT POWER LATHES**  
 For Electrical and Experimental Work.  
 For Gunsmiths & Tool Makers. For General Machine Shop Work.  
 High Grade Tools; elegant in design, superior in construction. The best foot power lathes made, and quality considered, the cheapest. Send for catalogue and prices.  
**W. F. & JOHN BARNES CO., 1999 Ruby St., Rockford, Ill.**

**INVENTORS** Write us. We have perfect facilities for producing their Models and manufacturing their Electrical and Mechanical Specialties. **SOUTHERN ENGINEERING CO.,** Electrical and Mechanical Engineers, Louisville, Ky.

**ARMSTRONG'S PIPE & THREADING CUTTING-OFF MACHINES**  
 Both Hand and Power.  
 Water, Gas, and Steam Filters' Tools, Hinged Pipe Vises, Pipe Cutters. Stocks and Dies universally acknowledged to be the BEST. Send for catalog.  
**Armstrong Mfg. Co.,** Bridgeport, Conn.

**A New and Valuable Book.**

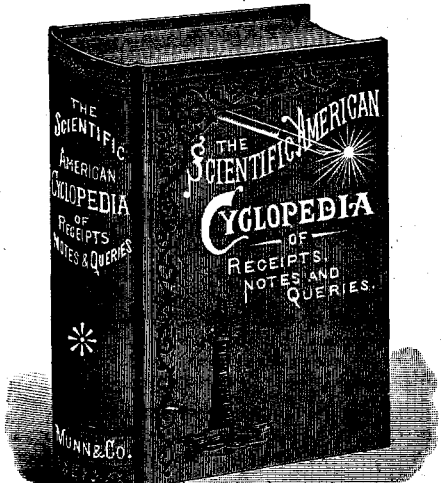

**12,500 Receipts. 708 Pages. Price \$5.**  
 Bound in Sheep, \$6. Half-Morocco, \$6.50.

This splendid work contains a careful compilation of the most useful Receipts and Replies given in the Notes and Queries of correspondents as published in the Scientific American during the past fifty years; together with many valuable and important additions.

Over Twelve Thousand selected Receipts are here collected; nearly every branch of the useful arts being represented. It is by far the most comprehensive volume of the kind ever placed before the public.

The work may be regarded as the product of the studies and practical experience of the ablest chemists and workers in all parts of the world; the information given being of the highest value, arranged and condensed in concise form convenient for ready use.

Almost every inquiry that can be thought of, relating to formulae used in the various manufacturing industries, will here be found answered.  
 Instructions for working many different processes in the arts are given.  
 Those who are engaged in any branch of industry probably will find in this book much that is of practical value in their respective callings.  
 Those who are in search of independent business or employment, relating to the home manufacture of sample articles, will find in it hundreds of most excellent suggestions.  
 Send for Descriptive Circular.  
**MUNN & CO., Publishers,**  
**SCIENTIFIC AMERICAN OFFICE,**  
**361 Broadway, New York.**



Founded by Mathew Carey, 1786.  
**HENRY CAREY BAIRD & CO.**  
 Industrial Publishers, Booksellers, and Importers,  
 510 Walnut St., Philadelphia, Pa., U. S. A.  
 Our new and Revised Catalogue of Practical and Scientific Books, 88 pages, 8vo, and our other Catalogues and Circulars, the whole covering every branch of Science applied to the Arts, sent free and free of postage to any one in any part of the world who will furnish his address.

TENS of thousands of visitors to the World's Fair felt a sense of regret at their ignorance of recent advances in many very common branches of science and the mechanic arts. The need of keeping abreast of current achievement and discussion is met by the brief articles from authoritative pens, free from technicalities, to be found in THE POPULAR SCIENCE MONTHLY.

Sold everywhere, 50 cents a copy.  
 Subscription price, \$5.00 a year.  
**D. APPLETON & Co., New York.**

**GATES ROCK & ORE BREAKER**  
 Capacity up to 200 tons per hour.  
 Has produced more ballast, road metal, and broken more ore than all other Breakers combined. Builders of High Grade Mining Machinery. Send for Catalogues.  
**GATES IRON WORKS,**  
 50 C So. Clinton St., Chicago  
 136 C Liberty Street, New York  
 237 C Franklin St., Boston, Mass

**Valuable Patent For Sale, No. 505,482**  
 Machine for Sawing Logs, Trees or Splines. For Dock Building, Lumbermen, Cutting Telegraph Poles, etc., making a perfect cut at any angle.  
**A. R. SEARLY, 48 West 18th Street, New York.**

**DEAFNESS**  
 and HEAD NOISES relieved by using Wilson's Common Sense Ear Drums. New scientific invention, entirely different in construction from all other devices. Assure the deaf when all other devices fail, and where medical skill has given no relief. They are safe, comfortable, and invisible; have no wire or string attachment. Write for pamphlet.  
**WILSON EAR DRUM MFG. CO.,**  
 Louisville, Ky.

**Model & Experimental Work.** Absolute secrecy. Advice and ideas not charged for. Send for particulars  
**GARDAM & SON, 36 John Street, NEW YORK.**

**KNITTING MACHINERY.**  
 Knitted underwear is in vogue. The best machinery for its manufacture, such as SHIRT MACHINES, SLEEVERS, BAR STITCH MACHINES, etc., are made by **SCOTT & WILLIAMS,**  
 2077 E. Cumberland Street.  
 Established 1865. Philadelphia, Pa., U. S. A.

**LIFE SAVING DEVICES.**— A COLLECTION of suggestions of devices for communicating between the shore and stranded vessels, offered to the London Daily Graphic by various correspondents. With 100 illustrations. Contained in SCIENTIFIC AMERICAN SUPPLEMENT, Nos. 848, 849, 850, 851, 852, 853, 854, 855, 856, 857, 858, 859, 860, 861, 862, 863, 864, 865, 866, 867, 868, 869, 870, 871, 872, 873, 874, 875, 876, 877, 878, 879, 880, 881, 882, 883, 884, 885, 886, 887, 888, 889, 890, 891, 892, 893, 894, 895, 896, 897, 898, 899, 900. Price 10 cents each, or \$1.00 for the series. To be had at this office and from all newsdealers.

**Biggs Patent Medicated Hair Cloth Lined HARNESS PAD** for sore backs and necks on horses. A sure cure. An absolute preventive. **GEO. E. ELY & CO., ROCHESTER, N. Y.**

**WHO can supply Automatic Machines for Manufacturing Pressed Steel Vessels in large quantities? Offers should be sent marked M. 4217. Rudolf Mosse, Hamburg, Germany.**

**BUY THE FOX PATENT SAFETY RAZOR**  
 EVERY MAN HIS OWN BARBER  
 MAKES SHAVING A LUXURY  
 NO DANGER OF CUTTING  
 SKIN DISEASES PREVENTED  
 RAZOR \$2.00. STROPPING MACHINE & STROP \$1.75.  
 BOTH IN ONE BOX \$3.75 BY MAIL FREE  
**E. LOTHAR SCHMITZ, DEALER**  
 92 & 94 READE ST. NEW YORK.

There is a Market for Your Specialties in England.  
 Agencies for Novelties Wanted.  
 ADDRESS: **RANKIN & CO.,** Merchants and Manufacturers Agents,  
 7 Snow Hill, London, E. C.  
 English and American References.  
 ACCOUNTS GUARANTEED.

**EVERY WATCH GUARANTEED NO KEY REQUIRED**  
**NEW \$1.50**  
**AMERICAN WATCH & CHAIN**  
 The one exactly represents our new 1894 American Lever Watch and Chain. It is not an imported watch, but entirely American produced in this country by the best skilled mechanics. Neither is it a clock, but a perfect watch of ordinary size, 2 1/8 inches in diameter, 1-4 larger than cut. It is perfect in mechanism and we furnish with each a POSITIVE GUARANTEE as an accurate time-keeper for one year. Our factory produced last year nearly 500,000 watches and we have proven beyond doubt, that America can make not only the BEST but the CHEAPEST watches. Do not be deceived by its low price or your past experience with other watches. Though cheap, it is good. The publisher of this paper will tell you that our guarantee may be relied on. DESCRIPTION: The movement is regular American Lever; Lantern pinion; 240 beats to minute; keyless (or stem) wind and set; 4 turns runs 24 hours; steel pinions; all parts of great durability and perfectly adjusted; escapement of the regulator; dust proof case, handsomely finished in nickel or gilt; weight of watch 8 5/8 oz. diameter 2 1/8 in.; fully GUARANTEED one year—same as an Elgin or Waltham. SAMPLE post-paid with HANDSOME CHAIN & catalogue \$1.50; 3 for \$4.00; 12 for \$15.00 by Express. AGENTS and Storekeepers apply at once. Mention Paper. **R. H. INCERSOLL & BRO., 65 BURLAND ST., N. Y. CITY**

**OF INTEREST TO FOUNDRYMEN!**  
 We wish to license a few more firms to manufacture our radiators, for steam and hot water heating, under a small royalty. This is a growing and profitable business specialty and is under strong patents. Will sell a complete outfit of flasks and patterns to start producing. No experimenting. Our late improvements make our radiators the best in the market. Agents wanted for the sale of our goods. Correspondence solicited from foreign countries.  
**HOLLAND RADIATOR CO.**  
 Works, Bremen, Ind. Office, 89 Lake St., Chicago, Ill.

**THE SIMPLEX TYPEWRITER**  
 250 GUARANTEED to do as good work as any high priced machine. Specially adapted for use in private correspondence. Sent by mail or express prepaid on receipt of \$2.50. In handsome walnut case, 50c. extra.  
**Address Simplex Typewriter Co., 35 Great Jones Street, New York.**

**VOLNEY W. MASON & CO.**  
**FRICTION PULLEYS, CLUTCHES, and ELEVATORS**  
**PROVIDENCE, R. I.**

**THE "CLIMAX" Stereotyper and Moulding Press**  
 combined, for making perfect Celluloid Stereotypes to be used in place of metal stereotypes. Also for making Rubber Stamps. Should be in use in every printing office.  
 See SCI. AM., Dec. 30, 1893. Send for circular to  
**THE J. F. W. DORMAN CO.**  
 217 E. German St., Baltimore, Md.  
 Manufacturers of Rubber Stamps, Vulcanizers, Stereotype Machinery and Supplies.

**HARRISON CONVEYOR!**  
 For Handling Grain, Coal, Sand, Clay, Tan Bark, Cinders, Ores, Seeds, &c.  
 Send for Circulars. **BORDEN, SELLECK & CO., Sole Mfgs., Chicago, Ill.**

**THE "OLIN" GAS AND GASOLINE ENGINES,**  
 FROM 1 TO 10 HORSE POWER, FOR ALL POWER PURPOSES.  
**THE OLIN GAS ENGINE CO.,**  
 222 CHICAGO STREET, BUFFALO, NEW YORK.

**PATENTS**  
**CAVEATS, TRADE MARKS, COPYRIGHTS.**  
**CAN I OBTAIN A PATENT?** For a prompt answer and an honest opinion, write to **MUNN & CO.,** who have had nearly fifty years' experience in the patent business. Communications strictly confidential. A Handbook of Information concerning Patents and how to obtain them sent free. Also a catalogue of mechanical and scientific books sent free.  
 Patents taken through Munn & Co. receive special notice in the Scientific American, and thus are brought widely before the public without cost to the inventor. This splendid paper, issued weekly, elegantly illustrated, has by far the largest circulation of any scientific work in the world. \$3 a year. Specimen copies sent free.  
 Building Edition, monthly, \$2.50 a year. Single copies, 25 cents. Every number contains beautiful plates, in colors, and photographs of new houses, with plans, enabling builders to show the latest designs and secure contracts. Address **MUNN & CO., New York, 361 BROADWAY.**

**SMALL** Mfrs. metal goods can find reliable agent. Commission. **C-16 Lord & Thomas, Chicago.**

**AGENTS COIN**  
 Money selling Beveridge's Automatic Cooker. Latest and best cooking utensil ever invented. Sells at sight. One Agent sold over 1700 in one town. One sample Cooker free to good agents. Advertising matter furnished. For full particulars address **W. E. BEVERIDGE,** Box 728, Baltimore, Md.

**Family Ice Machine** Ice, etc., in a few minutes, \$10 and up. Filters, \$1.25 and up. Cookers, \$1. Seltzateurs to prepare one's self soda water, \$4.50 and up. **L. DERMIGNY, 126 W. 26th St., N. Y.**

**THE "MUNSON" TYPEWRITER.**  
 This machine is an "evolution," the outgrowth of years of experience and the best results of scientific work. Its principles appeal at once to the educated mechanic. It is light, small, compact, easily operated, with Universal Key Board.  
**INTERCHANGEABLE STEEL TYPE WHEEL,** durable and easily kept in order. 30 keys, 90 characters. Weight, with carrying case, 16 pounds. Special wheels for different languages.  
 Highest Medal Awarded, World's Fair, Chicago, 1893. Send for circular to **The Munson Typewriter Co., 162 S. La Salle Street, Chicago, Ill., U. S. A.**

**L. G. WINN MFG. CO.**  
 116 S. Pennsylvania St., Indianapolis, Ind.  
**Models and Experimental Machinery.**  
 Will make any trick or device wanted. Articles Manufactured for the Trade. Write for information books and prices.

**HYPNOTISM: its Uses and Abuses.** The science easily acquired. Illustrated book, \$1. Prof. Anderson, S. A. 2, 182 State St., Chicago.

**MANUFACTURING RUBBER STAMPS**  
 by our improved process, with a "New York" Vulcanizer, is pleasant and profitable work, requiring little capital. Our Vulcanizers received Highest Award, Medal, and Diploma, at World's Fair, 1893. Circulars free.  
**Barton Mfg. Co., 336 B'way, N. Y.**

**MATCH MACHINERY, LATEST IMPROVED.**  
 Complete plants furnished. **JOS. C. DONNELLY, 1209 Buttonwood Street, Philadelphia, Pa.**

**BARGOCK & WILCOX CO. WATER TUBE STEAM BOILERS**  
 107 HOPE ST. GLASGOW, SCOTLAND.  
 MANUFACTURERS IN UNITED STATES, SCOTLAND, FRANCE, GERMANY, AUSTRIA.

**BITUMEN TUBES.** Makers of machinery for casting these tubes will please send prices and particulars to **JULIUS CARSTANJEN, Duisburg, Germany.**

**FASTER THAN SHORTHAND!**  
 Anderson's Shorthand Typewriter prints a word at one stroke! Price, \$25 weight, 3 lbs. It is a perfect substitute for stenography, and has already taken its place in many of the largest establishments in the country. You can learn at home without a teacher; no knowledge of shorthand necessary. Don't waste your time; begin practice NOW and you will be ready for WORK next month. **G. K. Anderson, 8th Floor, World Building, New York City, U. S. A.**

**The Improved Monitor Incubator.**  
 Hundreds of testimonials as to its merits over all other incubators. **MEDALS and DIPLOMA AWARDED AT THE WORLD'S FAIR.** Large book with cuts for stamp. **BUY THE BEST.**  
**A. F. WILLIAMS, 61 RACE ST., BRISTOL, CONN.**

**MONEY IN SPRING CHICKENS.**  
 The Hen is Not in It! The invincible egg hatcher does the business. Price, \$17.00. Big money. Send 4c. for Catalogue No. 46. It tells all. 2600 sold in 1893.  
**BUCKEYE INCUBATOR CO., Springfield, Ohio.**

**WORTHLEY STALL WORKS, 53 Elm St., Boston, Mass.,** have sold 8000 of his Patent 25-lb. Slow Feed Oat Mangers. Price, \$1.40. **VAN NESS CO., 50 Warren St., N. Y. W. Y. WARNER, 140 N. Broad Street, Phila.**

Send 5, 2-cent stamps for copy **World's Fair Souvenir** and figures on quantities to manufacturers, **J. W. TAYLOR, OWINGS BUILDING, CHICAGO, ILL.**

**MALLEABLE** AND FINE GRAY IRON AND STEEL CASTINGS FROM SPECIAL PATTERNS. FINE FINISH. JAPANESE AND ENGLISH PATTERNS.  
**THOMAS DEVLIN & CO., LEHIGH AVE. & AMERICAN ST. PHILA.**

**HE IS DEAD**  
 To his own interest, who deals in Arms and Ammunition or who shoots a Rifle Pistol, or Shot Gun and has not a copy of IDEAL HAND BOOK, No. 4, A 80 pages of solid information. Just out. (Mention Scientific American.) BE ALIVE and send for one FREE to all countries. Send stamps for postage.  
**IDEAL MFG. CO., Drawer 860, New Haven, Ct., U. S. A.**

**NOW READY!**  
**Fourteenth Edition of Experimental Science**

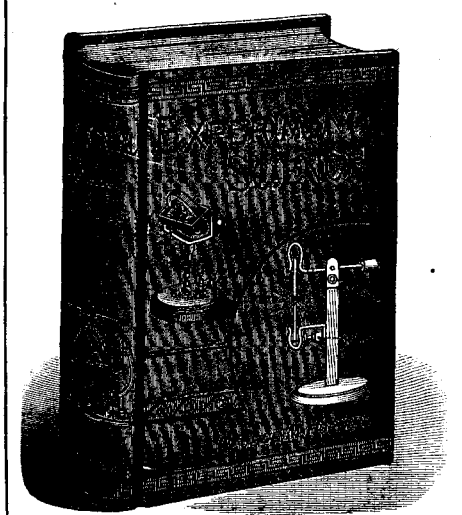

REVISED AND ENLARGED.  
 120 Pages and 110 Superb Cuts added.

Just the thing for a present for any man, woman, student, teacher, or any one interested in science. In the new matter contained in the last edition will be found the Scientific Use of the Photograph, the curious optical illusion known as the Anorthoscope, together with other new and interesting Optical Illusions, the Optical Projection of Opaque Objects, new experiments in Projection, Iridescent Glass, some points in Photography, including Hand Cameras, Cane Cameras, etc.; Systems of Electrical Distribution, Electrical Ore Finder, Electrical Rocker, Electric Chimes, How to Color Lantern Slides, Study of the Stars, and a great deal of other new matter which will prove of interest to scientific readers.  
 840 pages, 782 fine cuts, substantially and beautifully bound. Price in cloth, \$4. Half morocco, \$5.  
 Send for illustrated circular.

**MUNN & CO., Publishers,**  
 Office of the SCIENTIFIC AMERICAN,  
 361 BROADWAY, NEW YORK.

No man seeking small power, one, two and three H. P., would buy anything but the **OLDS GASOLINE ENGINE** if he investigates its merits, which are the cause of its wonderful demand where introduced.  
 Send for '94 Catalogue  
**P. F. OLDS & SON,**  
 Box 218, Lansing, Mich.

**THE FISHER Patent Steam Pump Governors**  
 For Steam Pumps Working under Pressure and the FISHER PATENT GRAVITY GOVERNORS For Steam Pumps filling elevated open tanks, are the most positive and durable devices made for the purpose.  
**REDUCING VALVES.**  
 Send for circulars and testimonials.  
**FISHER GOVERNOR CO.,**  
 201 S. 1st Avenue, Marshalltown, Iowa.

**AUTOMATIC HILL-He Pays the Express**  
 on this American-made Revolver. Full Nickel Plated, Rubber Stock, Center Fire, 32 or 38 Caliber, Five Shot, 8-in. long, rifle barrel 3/4 inch long fluted cylinder, 1 1/2 curved hammer which prevents accidental discharge. Weight 16 oz. Cut this out and we will ship by express C.O.D. \$4.00. We pay all charges.  
**W. HILL & CO.,**  
 207 State Street, Chicago.

**HOME ELECTRIC MEDICAL BATTERY**  
 Used and recommended by all physicians as infallible for Rheumatism, Neuralgia, and all nervous troubles. Send for Free Circular. AGENTS WANTED everywhere. \$10 A DAY easily made. **T. C. RAFFERTY & CO., Chicago, Ill.**

**ELECTRICITY**  
 By our correspondence method; 5 thorough courses; Experiments; reasonable Terms. Circulars Free. **The Scientific Machinat Co. Cleveland, O.**

**WOODEN TANKS** FOR RAILROAD WATER TANKS. MILLS, FARMS & COUNTRY HOMES. COMPLETE STOCK OF CYPRESS LUMBER.  
**W. CALDWELL CO.**  
 No. 217 E. MAIN ST. LOUISVILLE KY.

**The Scientific American PUBLICATIONS FOR 1894.**

The prices of the different publications in the United States, Canada, and Mexico are as follows:  
**RATES BY MAIL.**  
 The Scientific American (weekly), one year - \$3.00  
 The Scientific American Supplement (weekly), one year - 5.00  
 The Scientific American, Spanish Edition (monthly), one year - 3.00  
 The Scientific American Architects and Builders Edition (monthly), one year - 2.50  
**COMBINED RATES.**  
 The Scientific American and Supplement - 7.00  
 The Scientific American and Architects and Builders Edition - 5.00  
 The Scientific American, Supplement, and Architects and Builders Edition - 9.00  
 Proportionate Rates for Six Months.  
 This includes postage, which we pay. Remit by postal or express money order, or draft to order of **MUNN & CO., 361 Broadway, New York.**

Advertisements.

ORDINARY RATES.

Inside Page, each insertion, - 75 cents a line
Back Page, each insertion, - \$1.00 a line

The above are charges per agate line—about eight words per line. This notice shows the width of the line, and is set in agate type.



OVERMAN WHEEL CO.

BOSTON. NEW YORK. PHILADELPHIA.
CHICAGO. DETROIT. SAN FRANCISCO.
DENVER.

COLD FORGED PRODUCT.

"Rogers' Drive Screw."

Patented May 10, July 19, 1887;
July 10, 1888;
July 19, 1892.

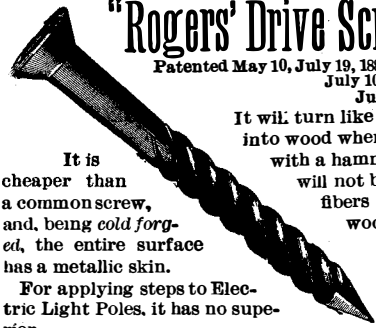

It is cheaper than a common screw, and, being cold forged, the entire surface has a metallic skin.

It will turn like a screw into wood when driven with a hammer, and will not break the fibers of the wood.

For applying steps to Electric Light Poles, it has no superior.

Send for samples to

AMERICAN SCREW CO. PROVIDENCE, R. I.

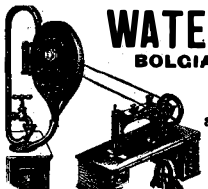

WATER MOTOR, \$5. BOLGIANO'S LITTLE GIANT

WILL RUN YOUR SEWING MACHINE

and other Light Machinery. A week's work done in a day. No Plumbing Required.

No. 1, 5-in. wheel, \$5
" 2, 13-in. " 10
" 3, 18-in. " 15
1-2 to 5 horse power, 50
Delivered free on receipt of price

THE BOLGIANO WATER MOTOR CO. 415 Water Street, Baltimore, Md.



"PARAGON" SPEED INDICATOR.

Superior to all others on market.

LINTNER & FORBORG, Gloversville, N. Y.

The American Bell Telephone Company,

125 Milk Street, Boston, Mass.

This Company owns Letters-Patent No 463,569, granted to Emile Berliner November 17, 1891, for a combined Telegraph and Telephone, and controls Letters-Patent No. 474,231, granted to Thomas A. Edison May 3, 1892, for a Speaking Telegraph, which Patents cover fundamental inventions and embrace all forms of microphone transmitters and of carbon telephones.

DERBY Library Tables
Ball-Bearing Chairs
Office Furniture
Specialties.
Derby, Kilmer & Pond Desk Co.
95 Causeway St., Boston.
Send 42-cent stamps for 36-page illustrated catalogue.

DAIMLER MOTOR COMPANY.

BUILDERS OF

Highest Grade Single and Twin Screw Launches.



Safest, cleanest and speediest power boat built. No smoke or smokestack, no boiler. No steam or naphtha under pressure. Run on one pint of gasoline per horse power per hour, and are under way in less than one minute. No licensed engineer or pilot.

Send for Illustrated Catalogue and Price List.

OFFICE AND WORKS, "STEINWAY," LONG ISLAND CITY, N. Y.

KODAKS \$6.00 TO \$100.00

Eastman Kodak Company, Rochester, N. Y.

Send for Catalogue.

DON'T DRINK IMPURE WATER. WATER DISTILLING APPARATUS FOR FAMILY USE.

With this apparatus, every family can supply themselves with pure water for the table or other purposes with very little trouble or expense, and can be absolutely sure that they are not using filtered water that may be represented to them as pure water.

Pat. applied for. 516 W. 36th St., NEW YORK, N. Y.

AGENTS WANTED FOR FINE TOOLS IN EVERY SHOP. C.H. BESLY & CO. CHICAGO, ILL. U.S.A.

STEEL BALLS for MACHINERY JOURNALS and BICYCLES a specialty.

Balls from 1/8" to 2" diam. in stock. Balls of Any Material or Size made to order. Accuracy of sphere, size and uniformity of strength guaranteed.

Cleveland Machine Screw Co. 133 2d Ave., Cleveland, O.

GAS AND GASOLINE ENGINES.

2 TO 100 H. P. Noiseless, Simple, Economical, Durable. Guaranteed Superiority. Guaranteed Lowest Gas Consumption. 15 ft. to indicated, 17 ft. to actual h. p. Actual brake h. p. guaranteed.



Works on any gas that will burn. For Electric Lighting it is as accurately governed as any steam engine at same speed. Sold on TRIAL and under absolute guarantee. Adaptable to all power purposes.

SCIENTIFIC AMERICAN SUPPLEMENT. Any desired back number of the SCIENTIFIC AMERICAN SUPPLEMENT can be had at this office for 10 cents.

ROPER'S PRACTICAL HAND BOOKS FOR ENGINEERS AND FIREMEN.

By STEPHEN ROPER, Engineer. YOUNG ENGINEER'S OWN BOOK. Containing an explanation of the Principle and Theories on which the steam-engine as a prime mover is based, and for the private instruction of youths who show an inclination for steam engineering.

EDWARD W. MERRILL, Publisher, 1312 Filbert Street, Philadelphia.

Pipe Frame Truck Baskets Wire Standard Truck Baskets STEEL AND WOODEN TRUCKS PIPE FRAME SHOE RACKS WIRE LOOP RACKS L. MURRAY MOORE, Rochester, N. Y.

International Exhibition Industry, Science, and Art 1894-5. HOBART, TASMANIA (AUSTRALIA).

Under the Immediate Patronage of the Government of Tasmania.

SOLE OFFICIAL AGENTS FOR THE UNITED STATES OF AMERICA:

Messrs. WOLTMANN, KEITH & CO., No. 11 Wall Street, New York, to whom all communications should be addressed, and who will furnish information to intending exhibitors, secure space, and undertake the reception and direction of exhibits, and sale or return of goods in connection with the

TASMANIAN INTERNATIONAL EXHIBITION. Applications for Space Must be made Before May 1, 1894.

PATENTS taken through Munn & Co. receive special notice in the Scientific American. This splendid weekly paper, elegantly illustrated, has the largest circulation of any scientific work.

HARTFORD STEAMBOILER INSPECTION AND INSURANCE CO. MANUFACTURE OF BICYCLES.—A very comprehensive article giving the details of construction of every part of these vehicles.

DYNAMOS MOTORS 5 lights to 500. 1/2 to 50 horse power Complete plants for Sale or Lease.

ASTRONOMY Made easy and interesting with the help of our new Celestial Planisphere and Handbook. For descriptive circular, address POOLE BROS., Chicago, Ill.

H.W. Johns' Asbestos Roofing DURABLE. ECONOMICAL. This Roofing may be easily applied by unskilled Workmen. It is more durable than tin and costs about one half as much.

ELECTRIC STREET RAILWAYS. THE MOST EFFICIENT MOTOR ON THE MARKET. Railway Supplies of All Kinds. Highest Awards at the World's Fair. GENERAL ELECTRIC COMPANY, PRINCIPAL SALES OFFICES.

ENGINES, BOILERS & MACHINE TOOLS.

Complete outfits furnished. Send for prices and Catalogue "B." W. P. DAVIS, Rochester, N. Y.

ALUMINUM goods made in quantity at low price.

WELL MACHINERY Largest Works on Earth. All kinds of Well Tools. A fortune for the driller Boring Wells or Prospecting with Adamantine. Can take a core. A wonderful discovery of lifting water by air. Economical two-stroke Artesian pumping outfits.

OIL WELL SUPPLY CO.

91 & 92 WATER STREET, PITTSBURG, PA. Manufacturers of everything needed for ARTESIAN WELLS for either Gas, Oil, Water, or Mineral Tests. Boilers, Engines, Pipe, Cordage, Drilling Tools, etc. Illustrated catalogue, price lists, and discount sheets on request.

WE HAVE BEEN PAYING BIG MONEY for this space since 1886, advertising

The Charter Gas & Gasoline Engine AND IT HAS PAID US.

For Information, address Charter Gas Engine Co., Box 148, Sterling, Ill.

TELESCOPE SUNGLASS OPTICAL CO. A FIRST CLASS TELESCOPE APERTURE FOR 45.00 ALSO OUTFITS AT HIGHER COST AT LOWER COST

THE Scientific American

ESTABLISHED 1845. The Most Popular Scientific Paper in the World Only \$3.00 a Year, Including Postage. Weekly—52 Numbers a Year.

This widely circulated and splendidly illustrated paper is published weekly. Every number contains sixteen pages of useful information and a large number of original engravings of new inventions and discoveries, representing Engineering Works, Steam Machinery, New Inventions, Novelties in Mechanics, Manufactures, Chemistry, Electricity, Telegraphy, Photography, Architecture, Agriculture, Horticulture, Natural History, etc. Complete list of patents each week.

Terms of Subscription.—One copy of the SCIENTIFIC AMERICAN will be sent for one year—52 numbers—postage prepaid, to any subscriber in the United States, Canada, or Mexico, on receipt of three dollars by the publishers; six months, \$1.50; three months, \$1.00.

The safest way to remit is by Postal Order, Draft, or Express Money Order. Money carefully placed inside of envelopes, securely sealed, and correctly addressed, seldom goes astray, but is at the sender's risk. Address all letters and make all orders, drafts, etc., payable to MUNN & CO., 361 Broadway, New York.

THE Scientific American Supplement

This is a separate and distinct publication from THE SCIENTIFIC AMERICAN, but is uniform therewith in size, every number containing sixteen large pages full of engravings, many of which are taken from foreign papers and accompanied with translated descriptions. THE SCIENTIFIC AMERICAN SUPPLEMENT is published weekly, and includes a very wide range of contents. It presents the most recent papers by eminent writers in all the principal departments of Science and the Useful Arts, embracing Biology, Geology, Mineralogy, Natural History, Geography, Archaeology, Astronomy, Chemistry, Electricity, Light, Heat, Mechanical Engineering, Steam and Railway Engineering, Mining, Ship Building, Marine Engineering, Photography, Technology, Manufacturing Industries, Sanitary Engineering, Agriculture, Horticulture, Domestic Economy, Biography, Medicine, etc. A vast amount of fresh and valuable information obtainable in no other publication.

The most important Engineering Works, Mechanisms, and Manufactures at home and abroad are illustrated and described in the SUPPLEMENT. Price for the SUPPLEMENT for the United States, Canada, and Mexico, \$5.00 a year; or one copy of the SCIENTIFIC AMERICAN and one copy of the SUPPLEMENT, both mailed for one year to one address for \$7.00. Single copies, 10 cents. Address and remit by postal order, express money order, or check. MUNN & CO., 361 Broadway, New York.

Building Edition.

THE SCIENTIFIC AMERICAN ARCHITECTS' AND BUILDERS' EDITION is issued monthly. \$2.50 a year. Single copies, 25 cents. Thirty-two large quarto pages, forming a large and splendid Magazine of Architecture, richly adorned with elegant plates in colors, and with other fine engravings; illustrating the most interesting examples of modern architectural construction and allied subjects.

A special feature is the presentation in each number of a variety of the latest and best plans for private residences, city and country including those of very moderate cost as well as the more expensive. Drawings in perspective and in color are given, together with Plans, Descriptions, Locations, Estimated Cost, etc. The elegance and cheapness of this magnificent work have won for it the Largest Circulation of any Architectural publication in the world. Sold by all newsdealers. \$2.50 a year. Remit to MUNN & CO., Publishers, 361 Broadway, New York.

PRINTING INKS.

The SCIENTIFIC AMERICAN is printed with CHAS. ENNEP JOHNSON & CO.'S INK, Tenth and Lombard Sts., Philadelphia, and 47 Rose St., opp. Duane, New York