

SCIENTIFIC AMERICAN

[Entered at the Post Office of New York, N. Y., as Second Class Matter. Copyrighted, 1888, by Munn & Co.]

A WEEKLY JOURNAL OF PRACTICAL INFORMATION, ART, SCIENCE, MECHANICS, CHEMISTRY, AND MANUFACTURES.

Vol. LIX.—No. 15.
ESTABLISHED 1845.

NEW YORK, OCTOBER 13, 1888.

[\$3.00 A YEAR.
WEEKLY.]

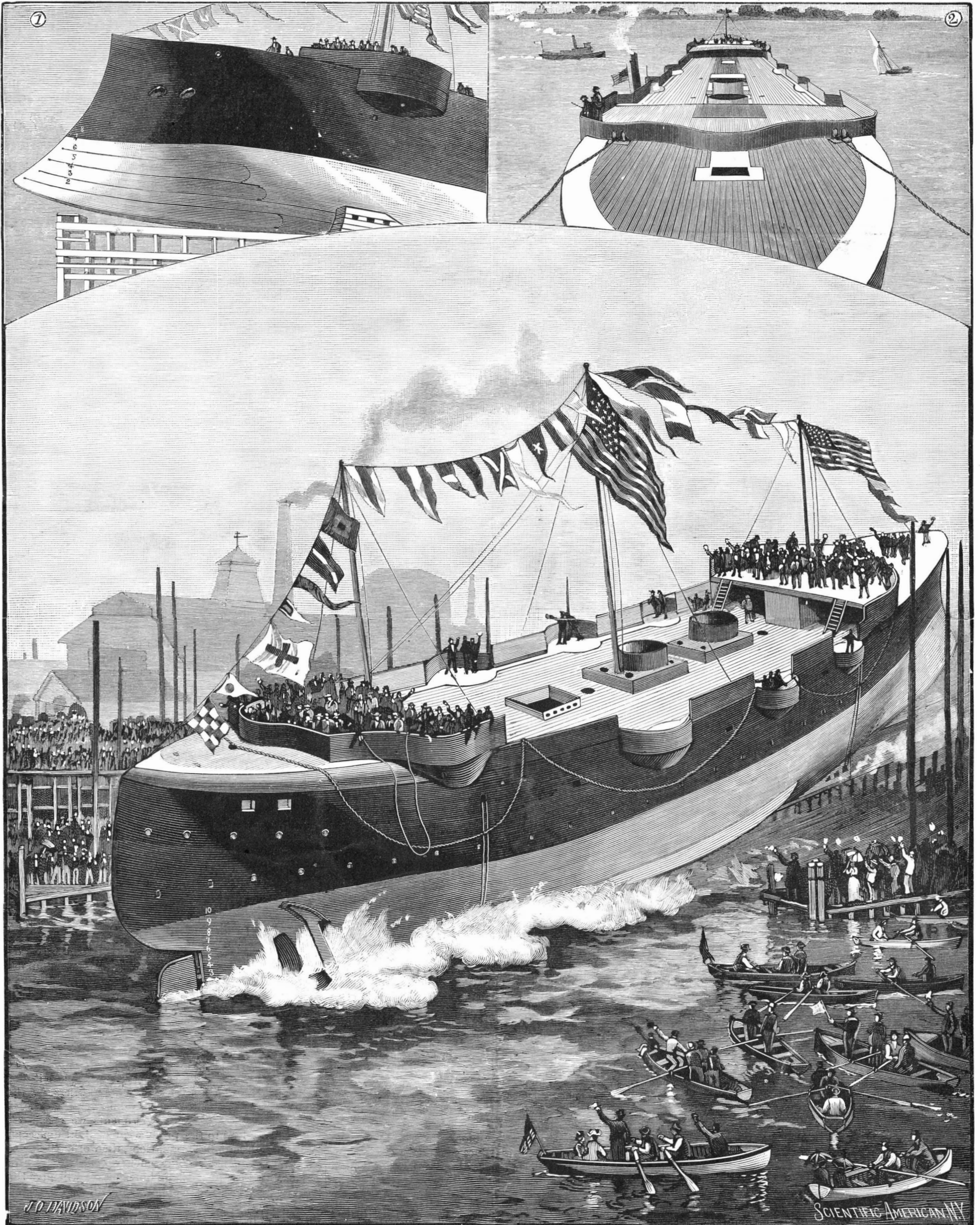

1. Ram and bow. 2. Deck view looking aft.

LAUNCH OF THE U. S. STEEL CRUISER BALTIMORE, 4,400 TONS, AT PHILADELPHIA, OCTOBER 6.—[See page 229.]

Scientific American.

ESTABLISHED 1845.

MUNN & CO., Editors and Proprietors.

PUBLISHED WEEKLY AT

No. 361 BROADWAY, NEW YORK.

O. D. MUNN.

A. E. BEACH.

TERMS FOR THE SCIENTIFIC AMERICAN.

One copy, one year, for the U. S. or Canada... \$3 00
One copy, six months, for the U. S. or Canada... 1 50
One copy, one year, to any foreign country belonging to Postal Union, 4 00

Australia and New Zealand.—Those who desire to receive the SCIENTIFIC AMERICAN, for a little over one year, may remit £1 in current Colonial bank notes. Address MUNN & CO., 361 Broadway, corner of Franklin Street, New York.

The Scientific American Supplement

is a distinct paper from the SCIENTIFIC AMERICAN. THE SUPPLEMENT is issued weekly. Every number contains 16 octavo pages, uniform in size with SCIENTIFIC AMERICAN. Terms of subscription for SUPPLEMENT, \$5.00 a year for U. S. and Canada. \$6.00 a year to foreign countries belonging to the Postal Union. Single copies, 10 cents. Sold by all newsdealers throughout the country.

Combined Rates.—The SCIENTIFIC AMERICAN and SUPPLEMENT will be sent for one year, to any address in U. S. or Canada, on receipt of seven dollars.

The safest way to remit is by draft, postal order, express money order, or registered letter.

Australia and New Zealand.—The SCIENTIFIC AMERICAN and SUPPLEMENT will be sent for a little over one year on receipt of £2 current Colonial bank notes. Address MUNN & CO., 361 Broadway, corner of Franklin Street, New York.

NEW YORK, SATURDAY, OCTOBER 13, 1888.

Contents.

(Illustrated articles are marked with an asterisk.)

Table listing various articles such as Alum baking powders, American Institute Fair opening, Axle box, improved, Barrel, centrifugal, Belt rest, improved, Bleaching agents on writing ink, Books and publications, new, Bosom board, improved, Brussels Exposition, Business and personal, Camera, pocket, Carriage road to Pike's Peak, Check row planter, improved, Coloring substances, artificial, Correspondence, Cruiser Baltimore, Cuff holder, improved, Darning stockings, device for, Deafness caused by the electric light, Diabetes, Doctors should write plain, Electric railway mountain, Electrical glass breaker, Electromotor trial, proposed, Fruit sirups, preparation of, Gas fuel for locomotives, Gas, natural, enormous results from, Maps and Views of things places at, Gata, automatic, for elevators, Glass, pliable, Glyptodon, the, Great Eastern moving to her last berth, Horse, disappearing, Hydrogen for balloons, Inventions, agricultural, Inventions, engineering, Inventions, index of, Inventions, miscellaneous, Labor, division of, Labrador, Letter envelope gum greatly needed, Lifeboats, collapsible, Light, direct production of, Moisture in houses, Museums, export, in Germany, Natural history notes, Naturalization, the right to, Notes and queries, Paper hanging machine, Parachutist, American, in England, Railway trains, fast, Railways, horse, Rudolph Clausius, Saccharine, Fahlberg's, in art, Salt, how to purify, Sea serpent, near view, Seat for use in bath tubs, Ship building, California, Sleeplessness, treatment of, Stars, number of, Subways, Philadelphia, new, Tailor's square, improved, Tooth, inherited deficiency of, Water colors, alteration of, Weighing machine, beating, Whooping cough.

TABLE OF CONTENTS OF SCIENTIFIC AMERICAN SUPPLEMENT No. 667.

For the Week Ending October 13, 1888.

Price 10 cents. For sale by all newsdealers.

Table listing sections I through X with page numbers. I. ASTRONOMY.—History of the August Meteors.—By W. F. DENNING.—Ancient records of the star showers of August, the results of the 1888 observations, interesting tabulation of records of the past and of to-day. 10680. II. CHEMISTRY.—Apparatus for Fractional Distillation in Vacuum.—By SPENCER B. NEWBURY.—A simple and effective apparatus for this purpose.—1 illustration. 10658. III. CIVIL ENGINEERING.—The Forth Bridge.—By F. E. COOPER.—A very full and authoritative account of the progress of work on the great cantilever bridge, followed by a discussion in which American and English representative engineers participated.—4 illustrations. 10650. IV. ELECTRICITY.—Dynamo Current Interferences with Telephone Systems and Means of Relief.—By C. B. McCLELLER.—A plea for the electric bell rather than of induction as the disturbing element in telephone lines, a suggestive paper. 10655. V. FINE ARTS.—The Soldier's Return.—By ROBERT DIEZ.—A bronze group forming part of a monument at Braunschweig, the soldier greeting his parents.—1 illustration. 10647. VI. MISCELLANEOUS.—Mr. Flinders Petrie's Discoveries in Egypt. 10650. VII. NAVAL ENGINEERING.—Improved Elevator Ferry Boat.—A ferry boat with elevating deck for dock and ship service at varying elevations.—4 illustrations. 10654. VIII. PHOTOGRAPHY.—Intensification, Weak and Strong.—Eight intensification processes, of as many degrees of strength, arranged systematically. 10648. IX. PHYSIOLOGY.—Note on Recreation. 10682. X. TECHNOLOGY.—British and American Cottons in China.—The relative quantities supplied from each source, with tabular statement of the imports of six years. 10649.

A LETTER ENVELOPE GUM GREATLY NEEDED.

In consequence of the decline in the supply of gum arabic, the Post Office department has been obliged to abandon its use of this excellent material as a sealer for letter envelopes. In lieu of gum arabic a filthy and foul-tasting compound has been substituted, which is a disgrace to the department and a nuisance to all who have occasion to seal a government envelope. Any one who closes a letter in the ordinary manner finds the lips soiled and a villainous taste left in the mouth.

It is to be hoped the ingenuity of chemists will be able to purify the substances now used, or produce a new gum that shall be free from the objections mentioned. Such an invention or discovery ought to prove highly profitable to its author, for it is greatly needed by the public.

A PROPOSED ELECTRO-MOTOR TRIAL.

The project of a large sleeping car company to have built for them a four-mile electrical railroad, for illustrating the advantages of each type of motor, will be the first really practical attempt to compare the various systems on the same line and under similar conditions. If the avowed purpose of the company may be accepted in good faith, and the projectors of the various systems will really assent to such comparative trials, we are likely to get at more cold facts concerning electro-motors than we have had for many a day. The advantages and defects of the overhead trolley system and the underground conduit plan will be exposed before critics eager to make them known. There is the curve on the plane and on grade, the straight line on grade, starting and stopping, unexpected weights and hauls, and the like. Which system can most quickly accede to the requirements, most readily overcome the various difficulties, and bear the handicapping? What are the relative advantages of taking the current from a wire overhead, and from a third rail, and from a sunken main?

The projectors of the third-rail system say that the trolley system is uncertain; the trolleys snap from their propelling wires or fly off at slight impediments, relying on the climbing capacity of the passengers in the car below to keep them in their places. On the other hand, the overhead people—we do not refer to celestial folk, who would not, of course, prevaricate about such small things as electro-motors—we say these overhead people declare the trolley system to be the only reliable one; the transmission of the electrical energy being wholly removed from contact with the ground, which, as is well known, is the worst of insulation, and carried through the air, which is the best. In the use of high tension currents, they aver, and it would seem with reason, that it is difficult to protect the public, and with low tension currents slight leakages often suffice to reduce the available energy below the amount required to operate the road. Those who may have watched unprejudiced the progress of the various systems of electrical locomotion will doubtless agree that each seems to have some special virtue in the way of economy or certainty of operation. And so it is to be hoped this wealthy manufacturing company is sincere in its promise to give each a fair trial. A four-mile line would seem to be adequate for the purpose, and the neighborhood of large stationary engines a most convenient starting point.

THE NEW PHILADELPHIA SUBWAYS.

The plan adopted for burying all the telegraph and telephone wires of Philadelphia has about it that air of cool consideration and substantiality that mark the Quaker mind. After long investigation of the hundred and one good, bad, indifferent, but always cheap plans for burying the wires, the managers of these companies have thrust all aside and hit upon an expensive system of their own in the belief—a reasonable one, be it said—that it will prove cheapest and most satisfactory in the long run. They will build a brick conduit eight feet high and four feet wide through the main streets and avenues. There will be fifty 3 inch iron pipes, each containing 100 wires, and so 5,000 wires in all. One connection only will be made with each block, a main running from the conduit and underneath the house line to the middle of the block, where, from the top of a tall pole, the wires will be run in mid air to the rear of each house. The estimated cost of construction, it is said, will be \$250,000. Powerful pumps will keep the conduit filled with dry air, and every foot of main may be subjected to daily inspection because of its generous dimensions.

As will be seen, it is not necessary, in such a system to tunnel every main street and avenue, but, at most, only every second or alternate one, for from one line the wires may be run to the blocks on either side. Indeed, the number of main lines could, it is obvious, be still further reduced by branching, and, doubtless, it was only the fear of possible trouble from complication that induced the Philadelphia managers to forego the temptation to so lessen their construction account. The work is now fairly started, indeed, a part on the south side of Market Street, from the Delaware River to Fourth Street, is nearly complete.

Curiously enough, the tunnel system has been looked upon, from the very first, as impracticable, because of its cost. Nor is this surprising when we remember that most of the estimates for construction were for lengths of lines greatly in excess of what is now found to be required, while some seemed to be based upon such elaborate construction as that of the Paris sewage system. This Philadelphia system, even though it should fail of success as first projected, may, through experiment and modification, yet prove the most worthy of all, and furnish criteria for a practical system of subway construction.

THE DIRECT PRODUCTION OF LIGHT.

In his paper entitled The History of a Doctrine, read before the American Association at their last meeting, in Cleveland, Prof. Langley gave a graphic account of the development of the undulatory theory of light. He held that much yet remained to be done in that field of research, and he formulated a definite object for investigation—the relations between radiation and heat. For at the present time it is far from clear how much heat the purely light-giving radiations from a luminiferous body can produce. The mechanical equivalent of light is as yet unknown.

We have every reason to believe that it is very low. There is little doubt that could we estimate the equivalent in energy of the light-giving radiations of a source of light, it would be surprisingly small. Acting on this idea, and assuming and probably believing that the hypothetical luminiferous ether is an actual entity, Prof. Lodge, in England, and Prof. Hertz, in Germany, have been making very interesting experiments in the direction of the production of light. Accepting the identity of luminiferous and electrostatic disturbance ethers in accordance with Clerk Maxwell's hypothesis, they have endeavored by rapidly alternating pulsations or electrostatic discharges to produce light waves without the intermediation of ignited or incandescent matter. Hertz produced such rapid alternations that, treating them as waves, their length would have been two meters. Lodge's oscillations were slightly longer.

Nothing is truer than that the contrast between the small amount of energy absolutely needed to produce light and the large amount that practically has to be expended gives a disparaging view of man's progress. In the flame of a candle, a lamp, or a gas burner the light is probably derived from ignited carbon. Yet in the case of gas, for raising this carbon to the light-giving temperature, not over one or two per cent of the heat of the flame is theoretically required. Of the total radiations of a gas flame, according to Sir. C. W. Siemens, but five per cent are luminous, and for an incandescent electric lamp he gives about the same ratio. These estimates can be accepted as provisional only, but they are at least indications of the amount of waste. In the maintenance of the incandescent electric lamp a full horse power is required to keep a few feet of minute carbon filament at the incandescent temperature. Taking the useful radiations at five per cent of the total, it follows that we should be able to run twenty times as many lamps could we produce radiations restricted to the range of light.

Prof. Lodge's way of putting the case is so very striking that we refer our readers to it, as given in the last issue of the SCIENTIFIC AMERICAN. He states his case as a whole with great clearness. Where he refers to "atom" he probably employs the word in the physicist's sense, and as a concession to accuracy might have done better in using the word "molecule." It is evident that to his mind the ether is a real entity. In this he corresponds with the general tendency of English physicists. In comparison with some of the positive views concerning the ether which were enunciated at the last British Association meeting, Prof. Langley's address on the subject of radiation reads almost like a proclamation of uncertainty. From such an authority as Prof. Langley, one who by his classic experiments on radiant energy has won the highest reknown, the quasi disclaimer comes with added grace.

The ether is still hypothetical; an a priori attempt to produce light by throwing it into oscillation by direct electric action seems based on an insecure foundation. A few years ago the world was startled by the announcement that the astronomer Lockyer had discovered the identity of all the elements and the unity of matter. When this came to be sifted down, it proved only a hypothesis, although a highly probable one, based on spectroscopic observations. It was so well founded that it holds ground to the present day as a probable proof. Yet in the practical sense it was nothing. When first reported many doubtless saw the transmutation of metals near at hand.

So it will be with the experiments we speak of. Should they lead to the production of light unaccompanied by obscure heat radiations, the world will be incalculably benefited. The energy corresponding to the maintenance of a single horse power will give the light of five thousand candles. Oil will be burned no longer, save in isolated places. An ordinary house will be lighted by a motor of 1/10 horse power. "Wasting the midnight oil" will have a mechanical as well as an intellectual significance. All the world, therefore,

must wish well to the patient investigations of Prof. Lodge and his co-laborer. Should they shorten their waves to the proper length, and find that they are light waves indeed, they will do more for civilization than Argand, Murdoch, and Lebon.

Gas Fuel for Locomotives.

An ordinary 3,000 gallon tender weighs about 73,400 lb., when in working order, with full tank and 12,000 lb. of coal. The tender, when empty, weighs about 36,400 lb., of which the tank alone accounts for about 8,000 lb. The trucks, sills, etc., therefore, weigh about 28,400 lb. and, when the tender is loaded, serve to carry a weight of 45,000 lb. in the shape of coal, water, and the tank itself. The carrying part of the tender, therefore, weighs about 63 per cent of the parts carried. If we assume that this proportion holds good in the far larger tender needed for natural gas, the weights come out as follows:

	Lb.
Gas tank.....	50,000
Gas.....	3,000
Water tank, say.....	7,000
Water.....	25,000
Total.....	85,000
Add 63 per cent for trucks, sills, etc.....	54,092
	139,092

Nor is this the worst of the story. Taking the average weight of the tender when fuel and water are half consumed, the ordinary and the natural gas tenders compare as follows:

	Natural gas tender.	Ordinary tender.
One-half supply fuel.....	1,930	6,000
Fuel tank.....	50,000	8,000
Water tank.....	7,000	
One-half supply water.....	12,500	12,500
Trucks, etc.....	54,092	28,400
Total.....	125,522	54,900

In other words, when both tenders are fully loaded, the natural gas tender is nearly double the weight of the ordinary tender of the same capacity, the excess of weight being 66,600 lb. When both tenders are half empty, approximately the average running condition, the difference in weight is over 70,000 lb., and the ordinary tender weighs less than 44 per cent of the natural gas tender.

Even if these immense differences in weight did not enhance the first cost and diminish the hauling power of a locomotive with a natural gas tender, the great increase in the length of the tender, necessitating an entire reconstruction of all round houses and turntables, would condemn the project.

The many useful and valuable properties of natural gas are self-evident, but a little consideration will show that it is very unsuitable for use on locomotives running any considerable distance. It is possible that under special conditions compressed fuel gas could be stored to run a locomotive a short distance. The necessity of making the tank and connections absolutely tight would probably be a serious objection. The gas that escapes from the present natural gas pipes is a source of danger, but the loss is made up from the ever flowing wells, whereas a leakage from a reservoir containing only a limited supply would soon mean a stoppage on the road for lack of fuel.—*Railroad Gazette.*

Collapsible Lifeboats.

The new Inman and International liner City of New York, which has just made her first round trip across the Atlantic, has as great, probably more, lifeboat accommodation than any other vessel afloat. In all says *Engineering*, she carries thirty boats of large size, capable of carrying every soul on board in ordinary sailings. It has only been possible to carry such a large number of boats without unduly encroaching on the promenading space by adopting semi-collapsible lifeboats. There are sixteen of the ordinary boats, ten of "Chambers' patent unsinkable semi-collapsible lifeboats," and four of "Berthon's patent unsubmergible lifeboats." The latter boats are now so well known that it is not necessary to describe them here. They collapse into one-fifth their width for stowage, and it is claimed for them that when wanted they can be extended almost automatically, inhaling at the same time from 100 to 200 cubic feet of air into eight separate air cells between the inner and outer skin. Chambers' boat is of much newer origin. A craft of 26 ft. length, 7 ft. beam, and 3 ft. 4 in. depth, has a displacement of 11 tons, and affords accommodation to forty people. The depth of the boat proper is 14 in., but above that is a canvas washboard fitted with galvanized iron stanchions and rails, and hinged to the gunwale of the boat. When raised to the perpendicular the washboard locks itself into position by means of stays. In the ship the boat only occupies a space 18 in. in depth, so that three may easily be placed the one above the other, and yet not occupy a greater height than the ordinary boat. There are formed around the inside of the hull something like forty air-tight compartments, of over 3 tons space, which gives the boat greater buoyancy. The bottom of the boat is so arranged that it may be used as a raft in the event of its being over-

turned, and rods and ropes are fitted to enable any one in the water to get on to such a raft or to right the boat when overturned. The seats in the inside of the boat are formed into tanks for stores, provisions, and distress signals. The advantages of these semi-collapsible boats may be appreciated when it is mentioned that had the same number of ordinary boats been placed on board the City of New York, nearly three times the space occupied would have been needed.

California Ship Building.

The building of the steel steamers Arago and Pomona and the launching of the cruiser Charleston have demonstrated the fact that as fine steel steamers can be built on this coast as at any place in the world. With this fact established, it is well for us to compare the advantages possessed by our ship builders over those of the East, and no better showing can be made than by comparing the new steel steamer Pomona, lately built by the Union Iron Works, and the steamer Corona, just launched from the yard of Neafy & Levy, Philadelphia. The Corona was contracted for October 29, 1887. She was to be 230 ft. long, 34½ ft. beam, and 16 feet deep. She was launched August 4, 1888. Now we propose to allow two months from that time to finish her and prepare her for sea. It will then take her two months to come round the Horn, two weeks to clean up and overhaul her, and two weeks to furnish her for her first trip, which will bring the time to about the 4th of January next before she will be ready for service.

The Union Iron Works contracted to build the Pomona September 14, 1887. She is 230 feet long, 33½ feet beam, and 16 feet deep. She was launched May 26, 1888. Was completed, furnished, loaded, and started on her first trip July 29, and returned to this port after a successful and perfectly satisfactory trip, August 4, on the morning of the same day the Corona was launched. Shipmasters inform us that a ship of this kind is worth \$130 per day, and the difference in time between the day the Pomona entered service and the day next year when the Corona will be here ready for work shows a large amount in favor of the Pomona. As to cost, the contract price for the Corona was \$188,000 in Philadelphia, or \$193,000 delivered here. The contract price of the Pomona was \$200,000, or only two thousand dollars more, and while the Pomona is at work earning money for her owners, the Corona has yet to be completed and make a long ocean voyage.

By this comparison we show that the Pacific Coast can build just as good, serviceable ships, and far more expeditiously than can the old yards of the Eastern coast.—*Wood and Iron, San Francisco.*

Opening of the American Institute Fair.

The fifty-seventh annual exhibition of the American Institute was opened Oct. 3, Mayor Hewitt delivering an address in which he felicitously compared the extensive and varied displays now made at these fairs with those which its managers were able to present to the public fifty years ago. There are said to be more articles on exhibition this year than ever before, every inch of available room having been taken. The building is tastefully decorated, the large fountain in the center of the hall, banked with flowers, ferns, and grasses, being unusually attractive in the bright illumination furnished by a profusion of electric lights, the moving machinery and the interested crowds of visitors making up a busy and animated scene in which some new attraction can always be found. The admission price has this year been reduced to twenty-five cents, that more people may avail themselves of an opportunity to see this display.

Artificial Coloring Substances.

The possibility that some of the numerous pigments now produced synthetically may be used for the purpose of coloring articles of food lends importance to any experiments that may be made as to their physiological action. Studies of the action of a few such compounds upon the animal organism have been made incidentally in the course of an investigation undertaken by Herr Weyl as to the relation between chemical constitution and physiological action (*Berichte*, xxi., 2191). Of the "nitroso" coloring compounds, only the "naphthol green B" was examined, and this proved innocuous when administered to dogs in doses of one or two grammes daily for a fortnight. Of the "nitro" compounds the dinitrocresol, or "saffron substitute," has already been reported as non-injurious. "Martius yellow," or dinitro-*a*-naphthol, which is well tolerated by rabbits, killed medium sized dogs when small doses were given by the stomach. A dog weighing 6,850 grammes, to which a half gramme dose was given on two successive days, and a gramme of the more soluble sodium salt on the third, died on the fourth day. Less than a gramme sufficed to cause the death of a similar dog when administered subcutaneously. It is noteworthy, however, that a sulpho acid of "Martius yellow," known as "naphthol yellow S," proved innocuous to dogs even when administered in four times those quantities.

Pieric acid, a "nitro" compound, has been long known to be poisonous. Concerning "aurantias" (hexanitrodiphenylamine) there seems to be some conflict of statement, which possibly finds an explanation in the occurrence of two isomeric compounds in commerce, an "aurantia" from the Berlin aniline manufactory having been found non-poisonous to rabbits, while one from Basle is said to have proved very injurious to men. Among the "azo" coloring compounds none that is poisonous has yet been met with by Herr Weyl. On the other hand, three "saffranin" preparations were all of them found to exercise a toxic action.—*Pharm. Journal.*

Beating the Weighing Machine.

The drop-in-a-nickel-and-get-your-exact-weight machine which stands on the platform of the Consolidated road's depot at Meriden was surprised and fooled a short time ago by a bright young lady from East Hartford. At the close of the State fair, among the crowd at the depot awaiting the arrival of the trains, three young ladies, whose ruddy and healthy complexion clearly indicated that they were from the country, were prominent. Tired of promenading in the waiting rooms, they sought the outside platform. They had gone but a few steps when the weighing machine caught their sight. After a careful inspection it was declared "very 'cute," but the leader of the trio was suspicious, and as she stepped upon the platform she put a button in the hungry aperture. It did not work. So the young lady joined her companions, and at a respectful distance gazed at the contrivance while a Silver City dude enriched the machine by a part of his winnings at the races and ascertained his avoirdupois. As the gleeful indicators returned from 125 to the zero point, the owner of the unsuccessful button was inspired with a thought, and after a long delay in finding her pocket, she fished out a five cent piece, a pencil, and a card.

Armed with these, she again stepped upon the platform—to the intense amusement of the bystanders—and dropped in the nickel. The indicator quickly whirled around to 135. She did not move, but put number 135 on the card, then said, "Step up here, Ethel." Ethel stepped, and the hand now pointed to 254. The number was put on the card, and Sarah was invited to join the progressive weighing party. The dial now showed that the scales had a burden of 354 pounds. As they stepped to the platform, to indulge in a lesson in subtraction, the indicator slowly sneaked to zero, apparently crestfallen by the cheap way in which it had been treated. The girls were from East Hartford, and the novel way that they beat the machine was heartily enjoyed by a number of spectators.—*Hartford, Conn., Post.*

Whooping Cough.

The value of Mobin's treatment of whooping cough by sulphurous acid is receiving strong confirmation from many sources. Dr. Manly, in the *Practitioner*, expresses the opinion that, if it was carried out in every case, at the end of six months the disease would be unknown. The method used by him is as follows: The patient is in the morning put into clean clothes and removed elsewhere. All his clothes and toys, etc., are brought into the bedroom, and sulphur is burnt upon a few live coals in the middle of the room. The fire is allowed to remain in the room for five hours, and then the windows and doors are thrown open. The child sleeps in the room the same evening. About twenty-five grammes (a little under an ounce) of sulphur to every cubic meter may be burnt. This is equivalent to rather more than ten grains per cubic foot. The room is fumigated in a like manner during the night; the patient practically living in an atmosphere of diluted sulphurous acid gas for some days, while in several cases the process is repeated at the end of a week.

Electrical Glass Breaker.

The *Pittsburg Dispatch* states that: "Several glass factories are now using electricity for a novel purpose. Heretofore, when they wanted to cut one of the large cylinders of window glass, a simple but primitive method was used. This consisted of the pulling out from the furnace of a thin shred of glass heated white. This was quickly wrapped around the bottle-shaped end of the cylinder, and it burned through or fractured the glass. A pair of tongs had to be used in the process. By the new method, the glass cylinder is encircled with a fine wire, the extremities of which are put in connection with a small electric battery. It is necessary that the wire adhere closely to the glass. When a current of electricity is passed through the wire, the latter becomes red hot and heats the glass beneath it. Then a single drop of water deposited on the heated place will cause a clean breakage of the glass clear around the path of the wire. Contrary to what takes place with the usual process in the treatment of this fragile material, it is found that the thicker the sides of the cylinder are, the better the cut."

AN IMPROVED BELT REST.

A device designed for use in connection with a line shaft and fast pulley, to support the belt and prevent it from moving when the machine to be driven is not in use, is illustrated herewith, and has been patented by Messrs. Benjamin F. and James F. Comstock, of Canton, Ill. On the shaft with the driving pulley is a second pulley, with an inwardly extending reduced flange adapted to engage the inside rim of the driving pulley, the flanged pulley being mounted to rotate on sector pins projecting from a collar on the inside of a sliding block, of which side and face views are shown in Figs. 3 and 4, the block being mounted to slide in guideways formed in the hanger, as shown in Figs. 1 and 2, so as to permit an up and down movement of the sliding block without its touching the line shaft. In a crosspiece in the bottom of the hanger is a set screw to limit the downward sliding movement of the block, the latter being connected at its upper end by a link with a lever fulcrumed on the hanger, which lever has at its outer end a downwardly extending handle. By pulling down upon this handle the upward sliding motion of the block throws the flange of the second pulley into contact with the inside of the rim of the driving pulley, when the operator can conveniently and easily shift the belt by operating the belt shifter. When the belt has been shifted, the sliding block moves downward until it rests on the set screw in the crosspiece in the bottom

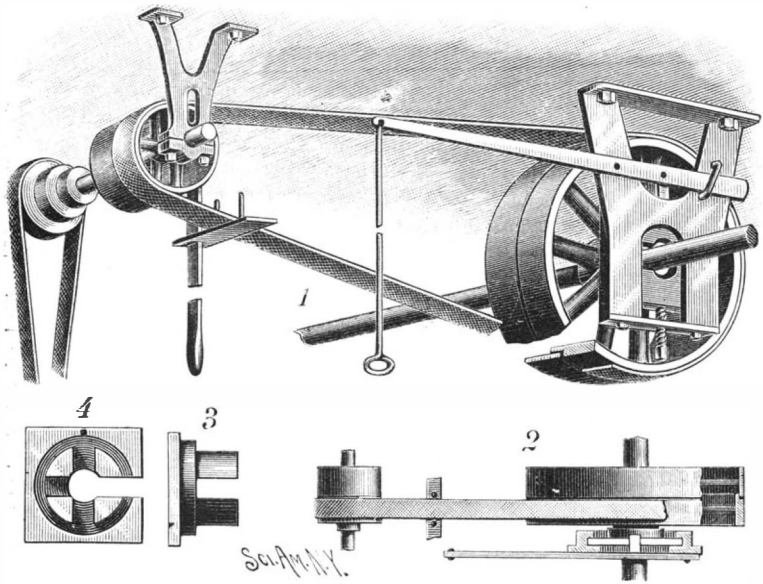

COMSTOCK'S BELT REST.

of the hanger, the pulleys then being out of frictional contact, and the flanged pulley ceases to rotate, resting on its sector pins until the operator again desires to shift the belt.

THE GREAT EASTERN MOVING TO HER LAST BERTH.

After thirty years' vain struggle against an adverse destiny, this leviathan steamship has been beached on the shores of the Mersey, to be broken up for old iron. The Great Eastern was planned by Mr. Brunel and built by Mr. Scott Russell, to accomplish the voyage to

the East, round the Cape, without having to stop by the way for coal, and was originally intended to take some 3,000 first, second, and third class passengers and a large cargo. Her length was 692 feet, her breadth 83 feet, and the depth of her hold was 24 feet, and her registered tonnage 18,914 tons. She was fitted with both paddle and screw engines, carried five funnels, each 100 feet high, and had a coal bunker space of 10,000 tons. She was built at Millwall, and great difficulty was experienced in the launch, which occupied three months, and cost 60,000*l*.

In 1859 the mammoth steamship started on her first trip to the United States, but had to put back through the explosion of a steam pipe, by which a number of persons were killed and injured. Next year she reached New York, and made several trips across the Atlantic, but the receipts were unequal to the enormous expenses. In 1861, she was utilized as a troop ship to take the Guards to Canada, but it was not until 1865 that her true vocation was considered to have been found—namely, to lay a telegraph cable between England and America. In this work she was occupied for some years—an attempt being made in 1867 to utilize her as a passenger ship between New York and Havre during the Paris Exhibition—but when there were no more cables to lay she was relegated to idleness and Sheerness, where cockney "trippers" were admitted to view her interior at a shilling a head. Two years ago the vessel was taken over by a syndicate, and stationed in the Mersey as a species of People's Palace of Amusement, being subsequently transferred to Dublin. After a brief visit to the Clyde, the Great Eastern was sent on her last voyage to the Mersey, where, recently, she was beached near New Ferry, on the Cheshire shore, to be eventually handed over to the dismantling hammer. Even to the last her ill-fortune appeared to attend her, as during her journey from the Clyde she encountered a gale, during which the tug was obliged to cast her loose, while her own engines, being stopped for a short time, the great vessel became unmanageable, and for hours rolled about at the mercy of the wind and waves. On the weather moderating, however, she was again taken in charge, and finally towed by the tug Stormcock to her last berth.—*London Graphic*.

DISPARAGING THE HORSE.—A

writer in one of our contemporaries thinks the intelligence of the horse is greatly overrated, and submits the result of some of his observations as evidence: I have seen horses walk around a post until they had wound up the bridle and then stand there with their heads bound down to the post, because they didn't have sense enough to walk the other way and unwind the bridle. I have seen them get a foot over the bridle when tied to a ring in the pavement, and then go into fits because they didn't have sense enough to lift their feet over the bridle again. I have seen them prance

around in a burning barn, with their tails and manes on fire, and burn to death, because they did not have sense enough to run out. Anybody can steal a horse without any objection from the horse. A horse will stand and starve and freeze to death with nothing between him and a comfortable stall and plenty of oats except an old door that he could kick down with one foot, or that could be opened by removing the pin with the teeth. If this is a high degree of intelligence even in a brute, then I am lacking in that article myself. Compared with the dog, the elephant, or even the parrot, the horse seems to me to be a perfect fool.

AN AUTOMATIC GATE FOR ELEVATORS.

A safety gate for the doorways of elevator shafts, designed to be automatically opened and closed by the

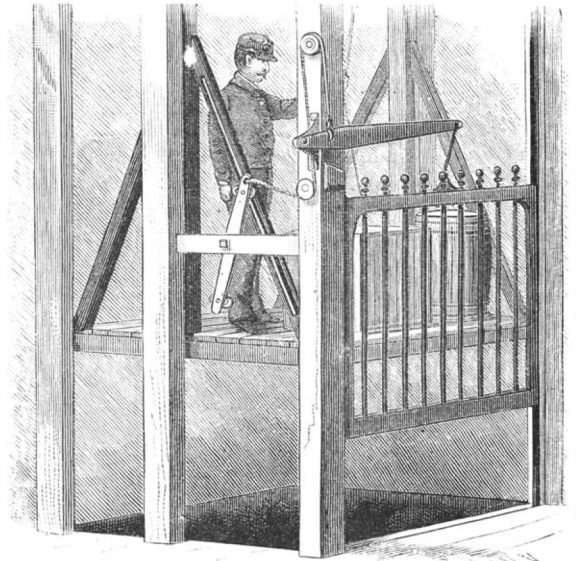

CALDWELL'S AUTOMATIC GATE FOR ELEVATORS.

elevator moving up and down, is illustrated herewith, and has been patented by Mr. John M. Caldwell, of No. 128 South Canal Street, Allegheny City, Pa. The sliding gate or door to the hatchway opening is suspended by a rope from the end of a lever pivoted to the framework, this lever being connected by a cord passing over pulleys on the framework to the upper end of a bar pivoted to a crosspiece of the framework. The bar has friction rollers at its ends, which engage the projecting edge of an inclined guide strip on the elevator as the latter moves up or down in front of the gate opening. When the gate is closed, the bar is inclined toward the door opening, its upper end being held down adjacent thereto by the weight of the gate. Upon the elevator approaching the gate opening, from above or below, the projecting edge of the upper or lower end of the guide strip on the elevator enters between a pair of rollers on the bar pivoted to the framework, moving its upper end away from the gate opening, and thus drawing on the cord to raise the gate. Upon the elevator moving away from the opening, either up or down, the guide strip passes between the rollers, permitting the gate to close.

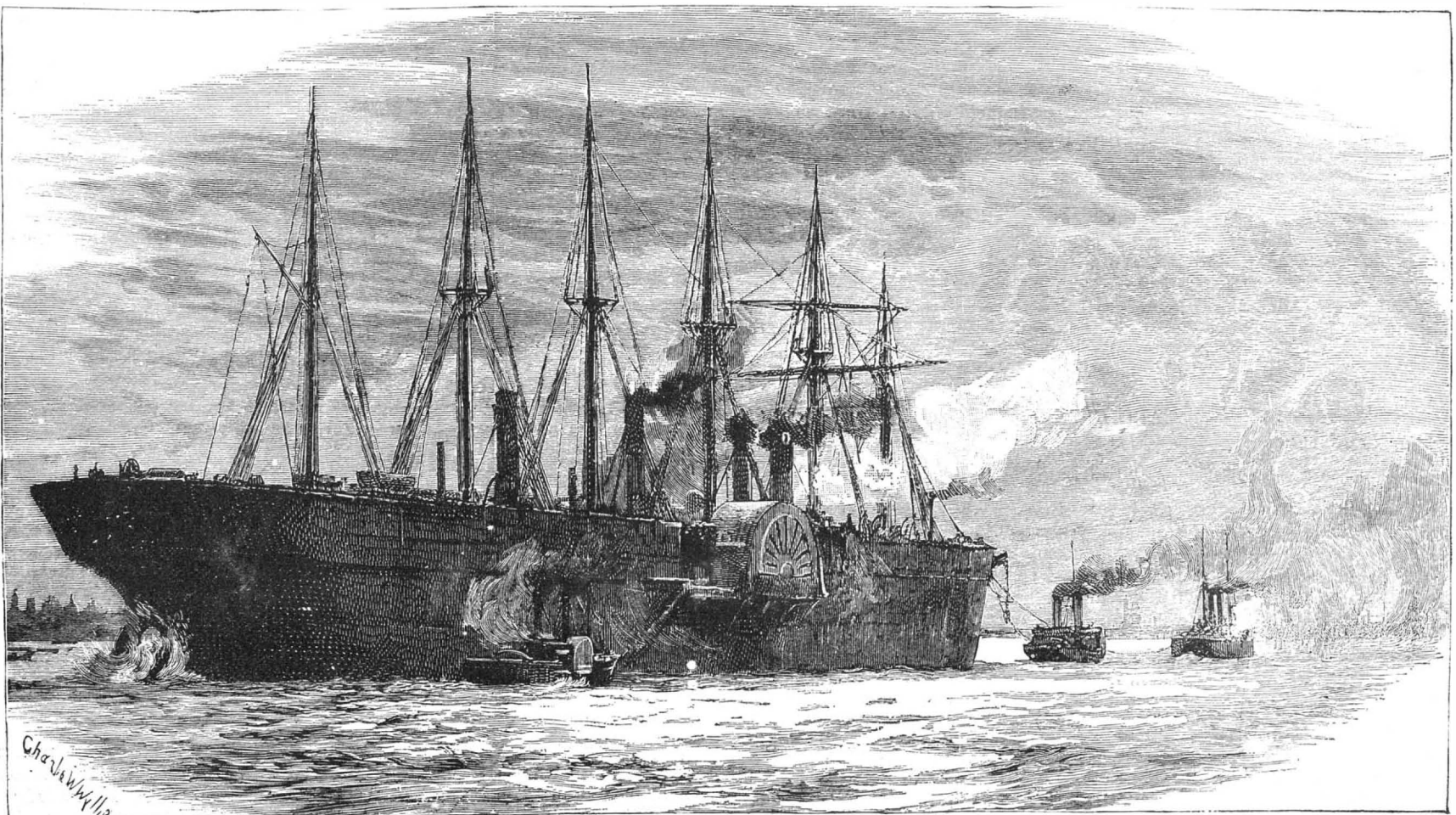

THE GREAT EASTERN MOVING TO HER LAST BERTH.

AN IMPROVED AXLE BOX.

An axle box specially designed for locomotives, and with which all wear can be easily taken up at any time, is illustrated herewith and has been patented by Mr. James Des Brisay, of Vancouver, British Columbia, Canada. The locomotive frame has the usual vertical arms in which the axle box is held to slide, the latter

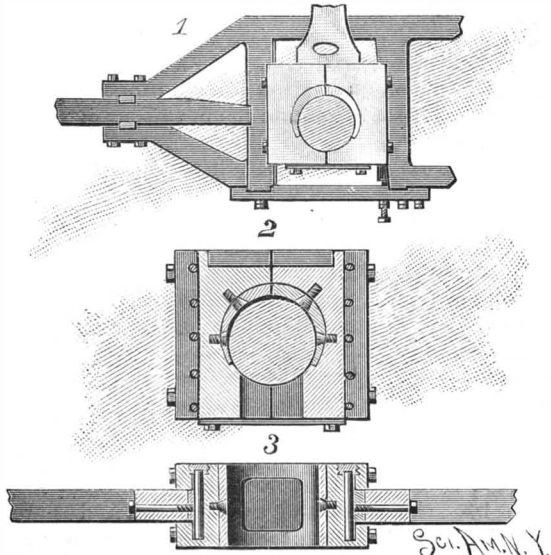

DES BRISAY'S AXLE BOX.

being preferably made in two parts, each carrying one-half of the brass bearing, secured by set screws or other suitable means, and on the inside of one arm is secured a steel plate, while on the inside of the other is held a steel wedge, adapted to be moved up and down by a bolt screwing in the bottom plate against the lower end of the wedge. The wedge and plate are held on the vertical arms by bolts passing through slots, as shown in the sectional plan view, Fig. 3. On each end of the two parts of the axle box are formed flanges fitting on the vertical arms, and in these flanges rollers are mounted to rotate loosely in contact with the steel plate and the wedge, as indicated in Figs. 2 and 3. In the lower part of the box is formed a recess, covered at the bottom by a plate, to be filled with waste or other suitable material which will absorb the oil necessary for lubricating the axle and box. When the axle is in place in the box, the friction of up and down movement caused by the weight of the locomotive is greatly reduced by the rollers traveling on the steel plate and wedge, and the wear is readily taken up by adjusting the wedge by means of the screw in the bottom plate bearing against its lower end.

AN IMPROVED CHECK ROW PLANTER.

A machine for planting hills of corn or other seed in accurate check row, with economy of time and labor, is illustrated herewith, and has been patented by Mr. John Clark, of Sheffield, Iowa. The frame of the machine is supported by a cranked axle on loose wheels, the tongue being so attached as to allow of vertical adjustment to accommodate the team and keep the main frame level. There are two cranks in the axle, one on

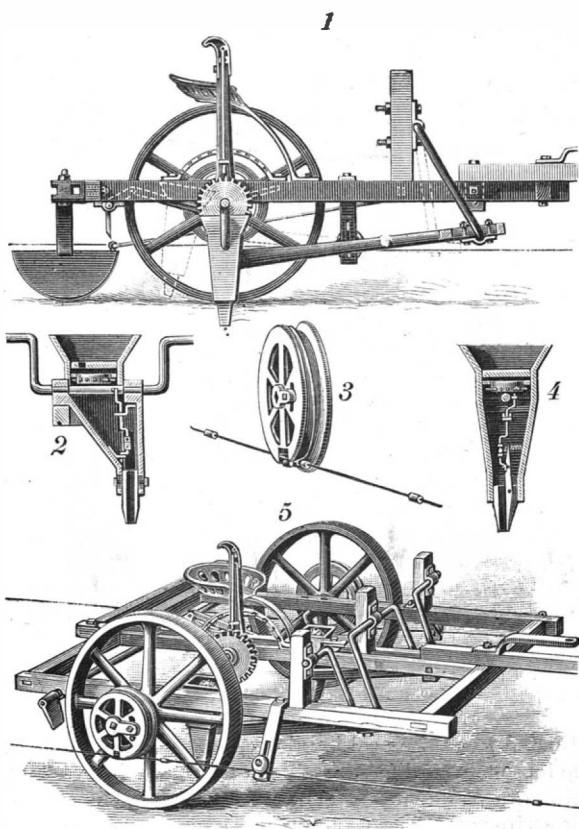

CLARK'S CHECK ROW PLANTER.

each side of the central longitudinal bars of the frame, on which are hung prods having superposed seed-carrying boxes, as shown in the sectional views, Figs. 2 and 4. To each of the prods is fixed the back end of a sway bar, which at its forward end is journaled on the wrist of a crank formed on a transverse shaft, there being two of these cranks in the shaft, both extending in the same plane, and each giving the same throw to one of the sway bars, while the shaft is so journaled that it may be raised or lowered as desired. The prod-carrying cranked axle is rotated to vertically reciprocate the prods by means of either one of two wheels, one at each end of the axle, and outside of the main wheels. These outside wheels are normally locked to the axle, but may be turned either way to adjust the machine and wheels with relation to the buttons on the check row cord or wire stretched along the field, to enter the prods into the earth a little sooner or later, to maintain accurate check row of the planted seeds. One of these outside wheels is shown in Fig. 3, its periphery being beveled downward and inward, and there being journaled in an open transverse slot therein a clutch wheel adapted to engage the buttons on the check row cord, to operate the prods, the check row wire making one complete turn around the wheel, and reeling on to and off from the wheel at its lower edge. To guide the wire to the lateral center of the wheel, grooved guide wheels are adjustably held by arms extending downward and outward from the frame.

The rotation of the wheel by the buttons on the check row wire, as the machine is drawn over the field, rotates the main axle, raising and lowering the prods attached to its crank portions with each revolution, and, as the sway bars of the prods are connected to the cranks of the transverse shaft journaled forward in the frame, the prods are oscillated so that they will extend forward at their bottoms or jaws as they enter the

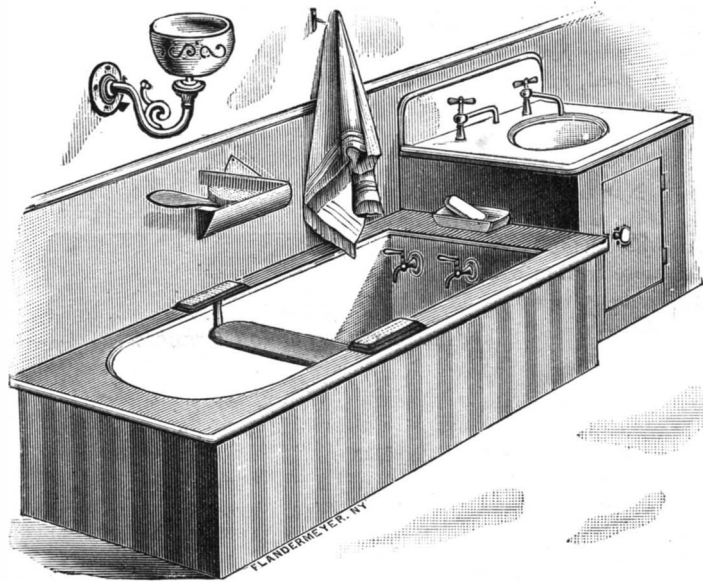

SLOAT'S SEAT FOR BATH TUBS.

ground, and extend backward as they leave the ground. The prod jaws are adjustable to secure shallower or deeper planting of the seed, which are caused to drop from the seed box into the body of the prod with each revolution, in regulated quantities for planting one hill at a time, the jaws of the prod opening to drop its charge when the prod stands vertically, having entered the ground to the maximum depth for which it had been set, the jaws closing immediately afterward until in position to drop the seed for another hill. During the travel of the machine, and while the prods are swinging between their extreme positions, the prod jaws accommodate themselves to the forward movement in a manner preventing their dragging in or through the earth, whether the planting be deep or shallow. While on the road, or when the machine is not planting, the prod-carrying shaft may be turned by hand and then locked to hold the prods up clear of the ground by means of a hand lever within convenient reach of the driver's seat. A marker is held by a shackle to the rear cross-bar of the frame, being stayed to the front end of the frame by a rod or chain in such way that it may be set to either side of the machine.

A SEAT FOR USE IN BATH TUBS.

An adjustable and sliding seat for bath tubs is illustrated herewith, and has been patented by Mr. George B. Sloat, of No. 1815 North Twenty-second Street, Philadelphia, Pa. The seat proper is preferably made of hardwood, and somewhat shorter than the ordinary width of a bath tub. It is provided at its opposite ends with bent metal arms forming hangers, by which the seat is supported in the bath tub, the lower ends of the hangers being bent to fit and slide within a longitudinal groove in the under side of the seat, where they are secured by thumb screws, being adjusted relatively to the ends of the seat as desired to adapt the seat to bath tubs of different widths.

FISH may be scaled easier by first dipping them into boiling water for a minute.

AN IMPROVED TAILOR'S SQUARE.

A square specially adapted for use by tailors and mantuamakers has been patented by Mr. Herman A. SENS, and is illustrated herewith. The inner edges of the plates between the arms of the square are preferably concave, that the square may fit snugly under the arm of a person being measured, and at the intersec-

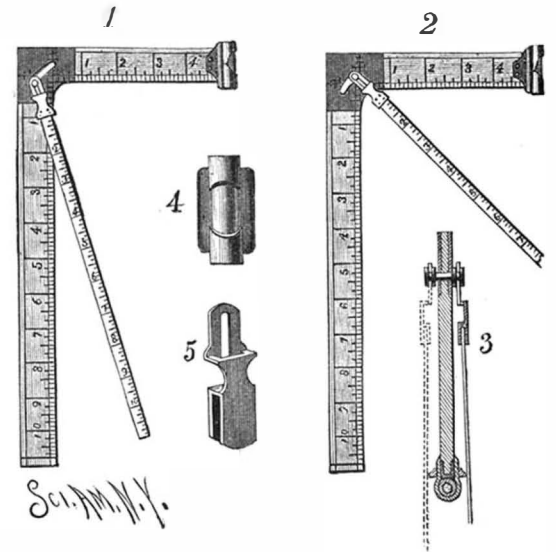

SENS' TAILOR'S SQUARE.

tion of the arms is a segmental slot in which travels a stud or pin having a head and collar upon each side of the center, as shown in the sectional view, Fig. 3. Upon the extremity of the short arm of the square is mounted a spirit level, shown in Fig. 4, enabling the operator to accurately establish the plumb line beneath the arm at the breast, the level being surrounded by an elastic cushion, so that its vial will not break when the square is thrown upon the table. The tape is provided at one end with a metallic ferrule of peculiar form, as shown in Fig. 5, and is attached to the square by the pin traveling in the segmental slot at the intersection of the corners, the pin also sliding in a longitudinal slot in the ferrule, whereby the tape may be carried in the direction of either arm of the square, or within or outside the arms. In other devices of this character the tape measures on the outside of the square, while here it measures on the inside, or directly on the body of the person being measured, thereby avoiding errors likely to occur in making allowance for the thickness of the square.

For further information relative to this invention address Mr. J. L. Hoffman, No. 13 East Fayette Street, Baltimore, Md.

AN IMPROVED PAPER HANGING MACHINE.

A machine for conveniently applying paste to the back of wall paper and cutting the paper from the roll in suitable lengths, preparatory to hanging it on the wall, is illustrated herewith, and has been patented by Mr. John F. McAfee, of Pleasant Hill, Mo. In bearings in one end of a suitably constructed frame is a roller carrying the paper to be hung, in front of which is a guide roller, under which the paper passes from the paper roller and thence over a paste roller, the latter having a fibrous covering, and dipping into a paste pan held under it, there being a scraper to remove superfluous paste from the paste roller. The paper next passes under a friction roller, under which is a drip pan, the

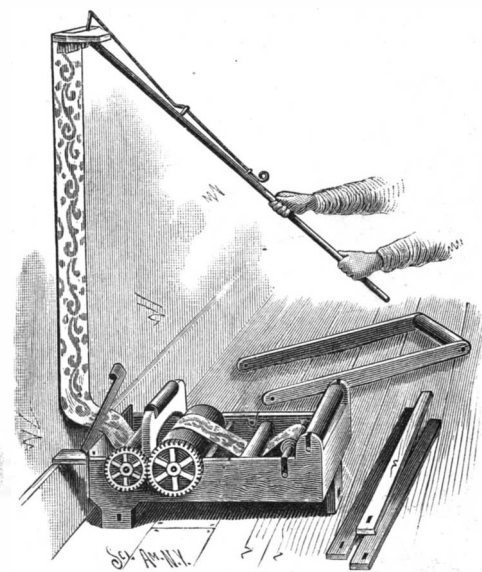

McAFEE'S PAPER HANGING MACHINE.

edge of the latter carrying a strip of cloth to even the paste on the paper, which then passes to the knife at the other end of the machine, which is provided with lugs to rest on the top of the mop board of the wall, the relative position of the lugs and the knife being such that the cut-off end of the paper will reach to the top

of the mop board. This machine is designed to be used in connection with an extensible paper-hanging clamp, also patented by the same inventor, and illustrated in our issue of September 8. The end of the paper, after it has been passed through the machine, is fastened in the clamp, when the operator, in raising the end of the paper up against the wall, by the same motion draws the required amount of paper through the machine, pressing its pasted side against the wall by means of the brush with which the clamp is provided, and cutting off the paper as it is attached. Extension legs for the machine and a roller-supporting frame, to assist in carrying the paper, are also provided for use in papering ceilings.

Moisture in Houses.

It is stated that the sudden change of the weather recently from cold to warm and damp, observes the Philadelphia Times, has caused thousands of dollars of damage to wall paper and other articles in houses. Of course it has, and it is so simply because many people do not study the plainest common sense principles in airing their houses.

One evening lately people went to bed with a hunt for extra blankets because of the sudden and severe chill in the atmosphere. When they rose in the morning, their bedrooms, parlors, dining rooms, etc., were yet chilly from the cold of the previous day, while the outside atmosphere had suddenly become not only warm, but hot and oppressive with dampness.

Inconsiderate people opened their windows and doors because the weather was warm, forgetting that the excessive moisture in the atmosphere would rush in with the warm air and swiftly deposit itself on the cold walls, furniture, etc., and penetrate wall papers, curtains, bedding, and everything within reach that presented a surface colder than the air that carried it into the house.

Of course the moisture loosened and discolored paper; made curtains as limp as a washrag; made beds damp and musty, and generally spoiled everything that water could spoil; but all could have been avoided by following the plain, common sense rule of not opening houses suddenly to suddenly changed atmosphere, carrying an excessive quantity of moisture.

A pitcher filled with cold water and placed in a room in summer will "sweat"—at least that is what it is commonly called. The pitcher does not sweat, because it is not porous and cannot sweat; but the cold water inside of it chills the outer surface, and, as soon as the outer surface of the pitcher becomes cooler than the atmosphere in the room, the moisture of the air will be precipitated upon the pitcher in drops.

This simple illustration should teach all housewives to avoid suddenly opening rooms in a house when the outside atmosphere is warmer than the temperature of the rooms and full of moisture. In all such cases the wall paper, furniture, etc., being cooler than the outside air, will speedily have the moisture of the atmosphere precipitated upon them, and it will require days to restore the house to the dry condition that is essential to health.

There are no arbitrary freaks in the laws which govern the atmosphere surrounding us, and there is nothing abstruse in mastering them. Warm, damp air will ever precipitate its moisture in houses or elsewhere whenever it comes in contact with anything chilled by a cooler atmosphere, and that is the whole story. The only thing to be added is that, when people have thus ignorantly or negligently allowed their houses to become damp, they should light fires and dry them as promptly as possible.

AN IMPROVED CUFF HOLDER.

A cheap and practical cuff holder, designed more particularly for ladies' use, while also suitable for use on

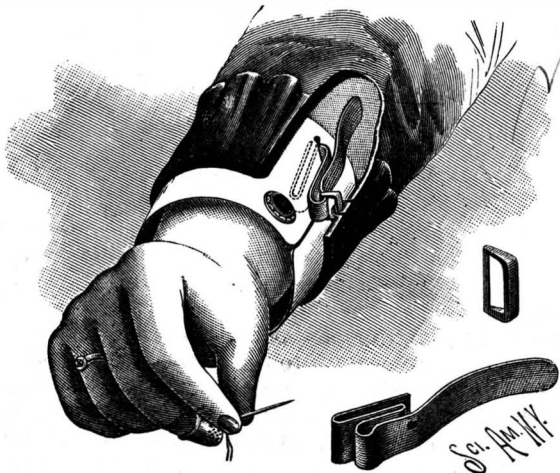

PERRY'S CUFF HOLDER.

gentlemen's cuffs, is illustrated herewith, and has been patented by Mr. Charles F. Perry, of Augusta, Me. It is made of a single strip of sheet metal, bent upon itself, as shown in the small view, the holder to be used with a loop made of wire or any suitable material, as shown, secured to the interior of the sleeve.

A DEVICE FOR USE IN DARNING STOCKINGS.

A suitably formed support for use in darning stockings, which may also be used as a receptacle for the thimble, needles, etc., is illustrated herewith, and has been patented by Mr. Charles Austin, of No. 30 East Fourteenth St., New York City. It consists of an egg-shaped shell divided into two interlocking sections, one of which is filled with emery, sawdust, or similar material, covered by a piece of suitable fabric secured to the inner walls of the section. This portion forms a needle cushion, from the center of which projects a post forming a thimble support. The other section of the shell



AUSTIN'S DARNING LAST.

is provided with a cushion-like drapery, whereby, when the two sections are united, the thimble, needles, etc., may be retained in position. The shell may be made of gold, silver, plated ware, rubber, ivory, celluloid, papier mache, or other suitable material.

Carriage Road to Pike's Peak.

Not the least interesting attraction at Cascade Cañon is its carriage road to the summit of Pike's Peak, which was formally opened on September 12. It is not a mere trail or a wood road, but it is as much of a carriage drive as can be made in climbing Rocky Mountains. It not only furnishes a safe and convenient route to the summit of Pike's Peak, but it affords a view, both in magnitude and magnificence, superior to all others obtained from other trails or roads. One who has been over both the old trail and the new road to the summit of Pike's Peak pronounces the sight to be had from Grand View to be even superior to the view from the summit of the Peak. From Cascade to the summit the drive is seventeen miles and the ride is one of five hours. From the hotel the drive is up Cascade Cañon, through wild and romantic scenery. Eight miles up it passes into Glen Cove, a vast amphitheater with a grassy pit through which course two pretty streams. Near here is what has been termed the Devil's Leap, a precipice 2,500 feet high. Near here, also, is a wonderfully balanced rock, 4 feet thick and 12 or 14 feet across, which may be swayed back and forth with one's hand. Twelve miles from Cascade is the Hayden Divide, and there on a mountain spur from Pike's Peak is the point—Grand View. The traveler is stopped in his journey here by the magnificent prospect before him, and he pauses to look at the great plains stretching far out to the east. He picks out Colorado Springs at his feet, Denver, seventy-five miles to the north, and Pueblo, fifty miles to the south. The course of the Arkansas River is traced. Looking southwest, the observer, if he is fortunate enough to be at Grand View when a train crosses Marshall Pass, may see quite a remarkable sight, for on the Pass, at an altitude of 10,852 feet, and ninety miles away, may be seen the smoke of the locomotive of a railroad train climbing the mountains.—Plains to Peaks.

Action of Bleaching Agents on Writing Ink.

BY R. IRVINE.

The author made a series of experiments to ascertain whether it is possible to tell the age of writing, and if writing has been executed at one and the same time, and if so at what time. He selected writing one day, six months, twelve months, two years, six years, fourteen, and twenty-two years old, and exposed these writings to the action of a very dilute solution of bleaching powder, specific gravity 1.001. In six minutes the newly written matter had disappeared; in from nine to twelve minutes the writing of six months ago had disappeared; in twenty minutes the writing of two years had partly disappeared; while in a like time the writing of six years ago was not greatly affected, of fourteen years ago very slightly, and of twenty-two years hardly at all. Hydrogen peroxide acts more slowly, but gives more definite results. When writing ink is thus bleached, most of the iron contained therein remains mordanted with the fibers of the paper. Consequently

writing so tampered with can be restored by the application of gallic or tannic acid. In determining the age of any particular writing, the following precautions should be observed:

1. The inks must be those known as ordinary writing inks, prepared from iron and chromium salts and galls.
2. Writing dried by means of blotting paper is more easily removed than writing which is allowed to dry on the surface of the paper.
3. The bleaching solution must be exceedingly dilute, otherwise the action is so rapid and powerful that both old and new writings are removed almost simultaneously.
4. The action must be carefully watched, so as not to be too long continued.
5. Very old writing, which has become brown by age, although it resists the action of weak solutions of bleaching powder and hydrogen peroxide, will show signs of giving way almost instantly when acted on by dilute nitric, hydrochloric, or oxalic acids.—*Jour. Chem. Soc.*

Rudolph Clausius.

Rudolph Julian Emmanuel Clausius, the noted German physicist, died at Bonn on the 24th of August. He was born in 1822 at Koeslin, in Pomerania. He began his studies at the gymnasium, and pursued them at the University of Berlin, and then at Halle, where he was made a doctor in 1848. In 1850 he was privat-docent at Berlin, where he at the same time taught in the Royal School of Artillery and Engineering up to 1855. Two years afterward he was appointed by the Swiss Federal Council to the chair of physics of the Polytechnic School of Zurich.

The work of Clausius was purely doctrinal. He made no experiments, and contented himself with applying the results obtained by others to his mathematical deductions. His work was connected with either general mechanics or thermo-dynamics and electricity. It was published for the most part in the *Annals of Poggendorf*.

His first memoirs upon the mechanical theory of heat date back to 1850, when he established the proposition upon which he relied to demonstrate the second law of thermo-dynamics, viz., that heat cannot of itself pass from a warmer to a colder body.

The chief memoirs of Clausius were printed in two volumes, which have had a large sale and been reprinted several times.

Clausius was correspondent of the Academy of Sciences from 1859 to 1882, and obtained the Poncelet prize for his works in general. He was a member of the Royal Society of London and of a large number of other learned bodies, and received a multitude of decorations.

AN IMPROVED BOSOM BOARD.

A board to facilitate the ironing of shirt bosoms, and which is applicable for use in connection with shirts of different sizes, is illustrated herewith, and has been patented by Mr. Frank H. Argersinger, of Newkirk Mills, N. Y. Layers of fibrous material are stretched over one face of the board, being held thereto by cleats screwed to the two sides and one end. In the outer faces of the cleats are grooves, in the ends of which are recesses extending into the edges of the board, and adapted to receive pins rigidly connected to clamping strips having tongues to fit in the grooves, these clamping strips being normally held against the cleats by spiral springs, and having handles by which they can be slightly pulled out against the tension of the springs. To one end of the board is connected a heart-shaped block having an extensible strip which may be

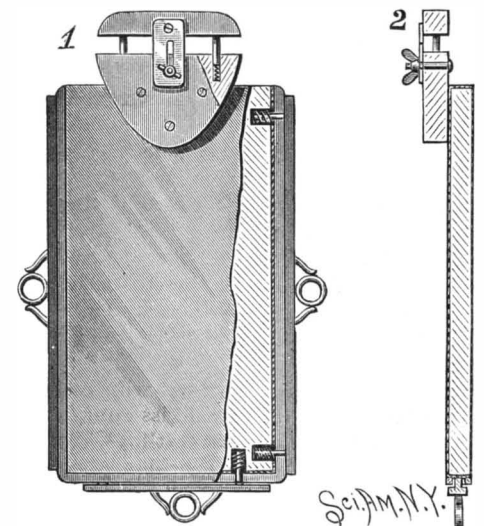

ARGERSINGER'S BOSOM BOARD.

adjusted to fit the neckband of the shirt to be ironed, the loose material at the sides and ends of the bosom being drawn down between the cleats and the clamping strips and there clamped to place, so that the bosom may be ironed without becoming wrinkled or pulled out of shape.

THE U. S. CRUISER BALTIMORE.

This new steel cruiser, built by Messrs. William Cramp & Sons, of Philadelphia, and which was to have been launched August 28, was at last successfully floated on the afternoon of October 6, in the presence of a numerous company of distinguished visitors. The Secretary of the Navy, with many officers of that branch of the service, and of the army, was present, as well as many members of Congress, while a liberal assemblage of interested and curious spectators, the guests of the great shipbuilders, marked their appreciation of the importance of the event by their attendance.

The Baltimore is designed to be the most formidable of all the unarmored ships now under construction for the navy. She is of the same size as the Philadelphia and Chicago, being 335 feet long and 48½ feet broad, with a mean draught of 19½ feet, and a calculated displacement, when fully equipped, of 4,410 tons. Her contract price was \$1,325,000, while that of the Chicago was \$899,000, but it is expected that the Baltimore will be much the more powerful ship of the two, as it is claimed that she has many important improvements in engine and ship construction, adopted since the Chicago was designed.

The Baltimore has a high freeboard, with poop and forecastle decks and an uncovered gun deck between, with a ram bow, while her rudder is well below the water line. She has an exceptionally thick protective deck, extending from bow to stern, the highest point of this deck amidships being but slightly above the water line, and curving down toward the ends of the vessel, as well as at the sides, where it slopes to six feet below the water line. The crown of this deck is about 2½ inches thick, gradually increasing toward the sides to 3½ and 4 inches, the form of the deck adding greatly to the structural strength of the vessel, while it is designed to afford a large measure of protection to the boilers, machinery, and magazine.

There are numerous watertight compartments above as well as below this deck, which, as well as the many subdivisions in the complete double bottom of the vessel, all have separate connections by which they can be drained by the pumps. The bunkers surrounding the engines and boilers are large enough to afford storage for 850 tons of coal, with which it is estimated the vessel can steam 2,000 miles at a speed of nineteen knots an hour, or 5,000 miles at a speed of fifteen knots, or 9,500 miles at a speed of ten knots.

The motive power is furnished by two triple-expansion engines of the latest type, separated by a watertight bulkhead and operating twin screws. The cylinders are 42, 60 and 94 inches in diameter, with a stroke of 43 inches, and the screws are three-bladed, 14½ feet in diameter. The engines are designed to develop 10,750 horse power, with forced draught, which should give a speed of from nineteen to twenty knots. There are two electric light plants, lighting all compartments of the ship, with 400 lamps, from eight to thirty-two candle power each. All compartments are ventilated by two blower engines, which have a capacity of 10,000 cubic feet of air per minute. Natural ventilation is also secured wherever possible.

The vessel has short military masts for signaling, which are fitted with circular platforms about sixty feet above the deck, where machine guns will be mounted, while the main battery will consist of four 8 inch steel breech-loading rifles and six 6 inch rifles. Two of the 8 inch guns are mounted on the forecastle, one on each side, on projecting sponsons, which permit firing ahead without interfering with the deck. Two 8 inch guns are similarly mounted aft on the poop deck, firing aft. These guns can also be fired across the bow and stern respectively within an arc of 5 degrees, which gives each gun a sweep of 165 degrees—95 degrees forward of the beam and 70 degrees abaft for the bow guns, and the reverse for the after ones, while they are all from 26½ to 28 feet above the water line. The six 6 inch guns are mounted on the main deck, three on each side, in projecting sponsons 18 feet above the water line. The forward 6 inch gun on each side can be fired directly ahead, and from that line around to 70 degrees abaft the beam—a total train of 160 degrees. The after 6 inch gun on each side can be fired directly astern and around to 70 degrees forward of the beam. The arrangement of the battery gives a heavy fire ahead and astern from two 8 inch and two 6 inch guns, throwing altogether 700 pounds of metal at a single round. The two middle 6 inch guns, one on each side, have a train of 70 degrees forward and 70 degrees abaft the beam, or 140 degrees total.

The machine gun battery will consist of six six-pounder rapid-firing Hotchkiss guns, six Hotchkiss revolving cannon, and four Gatlings, mounted in broadside, on the rail, on the bridge, and aloft in the tops. Two of the six-pounders are mounted under the forecastle, firing ahead, and two under the poop, firing astern. There are, therefore, sixteen machine guns of different sizes.

In addition to this battery, the vessel will be fitted with five torpedo launching tubes, two in the bow, firing ahead, one in the stern firing aft, and one training tube on each side. The vessel has also a conning tower, built of three-inch steel plates, on the after part

of the forecastle deck. It has all the fittings necessary for the captain to maneuver the ship and control the fire of the battery. The tiller ropes and shafting lead straight down from the conning tower and then along under the protective deck.

The Baltimore will be fitted as a flagship. The captain's cabin and staterooms are under the poop, while the admiral's quarters are below on the berth deck, at the stern of the vessel. Forward of the admiral's quarters is the wardroom, with accommodations for sixteen officers. The junior officers have ample room forward of the wardroom, while the remainder of the berth deck and the forecastle deck give ample space for the crew. The complement will be 300 men and 32 officers.

Messrs. Cramp & Sons were also the constructors of the Yorktown and Vesuvius,* and are now building the Philadelphia and Newark, the time for the completion of the contracts on which has been extended, so that it is not expected they will be launched until early in 1889.

The Right to Naturalization.

Two decisions have lately been rendered upon applications for naturalization which are likely to attract attention. One of these decisions was rendered by Judge Daniels, of the New York Supreme Court. Upon a close examination of an applicant for naturalization before him, and the usual witnesses, the fact was brought out that the applicant was in the habit of becoming intoxicated at no great recurring intervals of time, and while in that condition of abusing his wife and family, and that he had on several occasions been arrested and punished therefor. Judge Daniels refused the application for naturalization on the ground that the applicant was not proved to have behaved as a man of good moral character, well disposed to the good order and happiness of the United States, as required by the United States Revised Statutes. He said:

"This privilege of citizenship has been provided as a reward for good behavior and demonstrated attachment to the principles of free government. The design of the law is, in great part, certainly to induce and secure the co-operation of all the persons residing in the United States in supporting the laws and Constitution of the country. But this fidelity to its interests and progress is not to be expected from and will not be supplied by disorderly and dissipated persons. Reliance cannot be placed upon them for the support of the principles of free government or the enforcement of good order or the laws enacted to secure and promote it. They cannot, therefore, be held to be persons who have behaved themselves as persons of good moral character, and without that they are not permitted by the statutes to become citizens of the United States."

In another case, which came up in the Philadelphia Court of Common Pleas, the applicant, a Hungarian, when asked to take the oath of allegiance declared that he did not believe in a deity of any kind, and that he neither swore nor affirmed. His application was refused. Both these decisions seem to manifest a tendency on the part of the courts to scrutinize more closely the qualifications of foreigners for naturalization.—*Bradstreet's.*

A Near View of the Sea Serpent.

A dispatch to the Associated Press from Charleston, S. C., states that Capt. Hubbard of the steamer Planter, plying between Charleston and Georgetown, reports that the sea serpent was seen in Georgetown harbor on Thursday, August 20, half way between the port and bar. The tug Henry Buck passed within 200 yards of the monster, and the captain examined it carefully with his glass. He says he made out nearly its entire shape. It seemed to be resting or sleeping, the head and body being more or less exposed to view as the waves rose and fell about it. The mouth appeared to be beak-shaped, the head oval and quite large. The body looked to be as thick as a flour barrel, and lay upon and in the water in the curves common to snakes while swimming. The tail was not at first entirely visible.

While looking intently at the monster, something (possibly the noise of the tug) seemed to arouse it, and in an instant it threw its tail into the air, exposing fully fifteen feet of its length, and lashed the water into foam. It swam off in the direction of what is known as Muddy Bay and the mud flats, where it was impossible for the tug to follow. The color of the monster was very dark. The length is stated to be about fifty feet. That portion of the tail lifted above the water was between eight and ten inches in diameter. At the point where it was seen the water is fresh for several miles below, and Capt. Springs thinks the animal was made sick by it. It is thought that the monster cannot get out of the harbor.

As soon as the news was received, an expedition was made up to go in search of it, and it is possible that the sea serpent problem may yet be definitely solved. The monster was seen by the crews of both the tug and the schooner she was towing, the latter being bound for New York.

* For illustrated description of these vessels and their engines, see the SCIENTIFIC AMERICAN for May 12 and May 19, 1888.

Correspondence.**On the Detection of Fahlberg's Saccharine in Articles of Food.**

To the Editor of the Scientific American:

The fact that resorcine, when heated with concentrated sulphuric acid, alone gives rise to products which fluoresce strongly on the addition of alkalies does not appear to be generally known.

This reaction renders valueless the test described by E. Bornstein (page 10630 of the SCIENTIFIC AMERICAN SUPPLEMENT) for the detection of saccharine, based upon the supposed formation of a sulpho-phthalein. Were chemists to search for saccharine by Bornstein's process, they would unfailingly find it in all articles examined, whether actually present or not.

SAMUEL C. HOOKER, Ph. D.

Philadelphia, Pa., Oct. 3, 1888.

Fast Railway Trains.

To the Editor of the Scientific American.

Your correspondent G. H. S. is mistaken in supposing that three fast trains were omitted from the table in the *Railroad Gazette* by some oversight. If he will refer to the table as quoted in your columns, September 8, he will find that only some of the principal trains are given, running between the principal cities, and that in all cases only the trains running in one direction were taken. The trains from New York to Philadelphia are given, while those quoted by G. H. S. run from Philadelphia to New York.

I may observe that the article you quote from a daily paper on fast time on American railroads is somewhat misleading in stating that, in the fast run of the West Shore, July 9, 1885, "426 miles were covered in 7 hours and 27 minutes." The distance from East Buffalo to Weehawken is 422.6 miles, and this distance was covered in 9 hours 23 minutes, including stoppages. The actual time in motion was 8 hours and 17 minutes, giving an average speed while in motion of 51 miles an hour.

THE WRITER OF THE ARTICLE IN
THE RAILROAD GAZETTE.

New York, September 28, 1888.

Doctors should Write Plain.

The *Medical Register* (Philadelphia), under the heading of "One of the Lost Arts," takes the doctors to task for not writing their prescriptions more intelligibly. The writer claims that the druggist is liable to, and frequently does, make mistakes from misinterpreting the writing, and that the life of the patient is imperiled by their wretched chirography. The ordinary prescription is often as undecipherable as Egyptian hieroglyphics written upon papyrus of three thousand years ago, and what is worse, there does not seem to be any tendency toward improvement; the modern belief being that bad penmanship is an evidence of genius. The result is that the patients do not get the medicines ordered by the physician, or that which the physician supposes he orders.

Some years ago, the writer formed the acquaintance of a druggist who said that he did not pretend to follow the prescriptions sent him, because in many instances it would be unsafe for the patient to take the dose, and frequently the chirography was so miserable that it was impossible to make out just what the doctor wanted. He was consequently compelled to treat the patients himself, although to all appearances they were under the care of the regular physician. This plan was adopted after due deliberation and trial, the druggist finding that when prescriptions were returned for correction that was generally the end of the business, the prescriptions being sent elsewhere. Let us call a halt upon this failing, as it is due largely to sheer negligence; and when the writing becomes too burdensome by reason of lack of time, it would be the part of wisdom to employ a competent clerk for the purpose. By this means, it is hoped that we may be able to revive, if not rediscover, one of the lost arts. It will be better for the patient and, furthermore, will cause the druggist no sleepless nights, such as now threaten to drive him to distraction.

Diabetes.

One of our leading medical journals, which should be good authority on such subjects, copies from *Cassell's Magazine* the following new remedy for the above complaint:

A new drug, of apparently great value, has recently been introduced into the market. It consists of powdered jambil seeds—the seeds of a plant, *Syzygium jambolanum* or *Eugenia jambolana*, found in various parts of India, the Mauritius, Ceylon, and the United States of Colombia. It has been well tested by the medical faculty in England, Germany, and the United States, and is said to be a promising remedy in all cases of diabetes. The action of the drug is to prevent formation of sugar in the system and so to stay waste; and cases are on record showing that under its influence the special restrictive diet, so obnoxious to diabetes patients, can be dispensed with.

Pliable Glass.

A translucent material intended for use as a substitute for glass has been introduced in London. This material exhibits the quality of pliancy in the greatest degree; in fact, it may be bent backward and forward like leather, and be subjected to very considerable tensile strain with impunity. It is almost as translucent as glass, and is of a pleasing amber color, varying in shade from very light golden to pale brown. The basis of the material is a web of fine iron wire, with warp and weft threads about 1-12 in. apart. This is inclosed, like a fly in amber, in a sheet of translucent varnish, of which the base is linseed oil. There is no resin or gum in the varnish, and once it has become dry it will stand heat and damp without suffering any change, neither hardening nor becoming sticky. The manufacture is carried out by dipping the sheets edgewise into deep tanks of varnish and then allowing the coating which they thus receive to dry in a warm atmosphere. It requires more than a dozen dips to bring the sheet to the required thickness, and when this has been accomplished it is stored for several weeks to thoroughly set.

It will be readily understood that a material produced in this manner will not be as cheap as glass in its first cost. If it is to obtain a place in the market, it

to do is to dissolve a peck of it in cold water to saturation, add a small amount of sodium bicarbonate, and pour this into the barrel, having previously provided an exit by boring a hole in the bottom of the container. The saturated brine runs through, dissolves the impurities, and carries them off, but being saturated with chloride of sodium, it, of course, no longer attacks that substance.

THE CENTRIFUGAL BARREL.

The most successful part of the present Brussels Exposition is the garden, with its numerous restaurants and saloons, where the characteristic refreshments, wines, liquors, etc., of all nations attract the visitor, whether he is thirsty or not, and give to the whole more the appearance of a scene from a Flemish kirkness *a la* Rubens or Tenier than of an international industrial exposition.

This impression is heightened by the fact that the large garden is filled with show booths and amusements of all kinds, which, it has been correctly said, resemble a Vienna "Wurstlprater." We find there an open circus, a switchback under the pretentious name of "Montagnes Russes," a "Tonneau d'amour," which reminds one of the "Fasslutschen" at Kahlenberg,

French blue, and ultramarine ash. As for the thirty-four mixtures experimented with, only three remained entirely unaltered.

Messrs. Russell and Abbey made a second series of experiments for the purpose of determining how water colors and their mixtures behave every day in the ordinary atmosphere of a room. Fifteen colors and eleven mixtures were experimented with. Gamboge, indigo, and Naples yellow were but slightly altered, while all the other colors, as well as the mixtures, faded.

Finally, the two experimenters set out to discover what happens to colors placed in damp air, in hydrogen, in a vacuum, and under the influence of illuminating gas. They found, for example, that Prussian blue and Antwerp blue are totally destroyed by damp air, that illuminating gas has scarcely any effect upon colors, and that broad daylight has no perceptible action upon colors placed in a vacuum.

The Enormous Results from Natural Gas.

"Few people outside of the natural gas region," said a large owner of gas wells in Washington County, Pa., "have any idea what enormous proportions the gas business has grown to. It may be said to be only

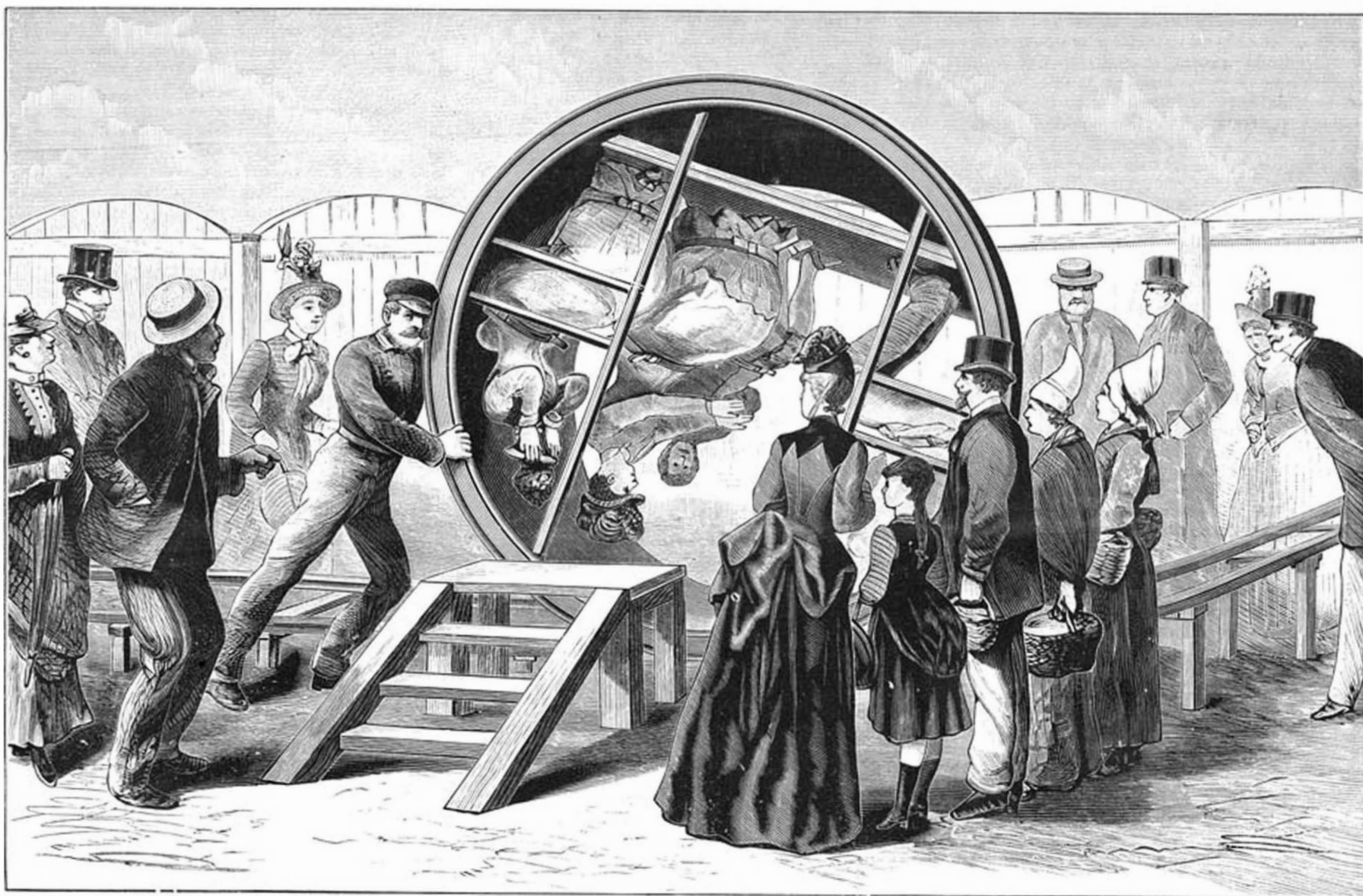

THE BRUSSELS EXPOSITION—THE CENTRIFUGAL BARREL.

must be either from its greater advantages or from some saving which it effects in the items of erection and maintenance. It is claimed for the woven roofing that it is economical in every way. It absolutely abolishes breakages; a man may fall upon it or drop a ladder upon it without damage. The large size of the sheets, 10 ft. by 4 ft., renders the joints very few, and these can be made absolutely tight by the use of varnish between the overlapping edges. No glazier is required to apply the material; it can be cut by a pair of strong scissors, and be nailed in place by any ordinary workman. The frames to carry it may be extremely light, and their construction of the simplest. Curved surfaces can be glazed as easily as flat, and if a great amount of light be required, the entire roofing may be made of this material. The sun's heat gets through with difficulty, so that no awnings are needed. It can be seen in London in the Westminster Aquarium, which has been lately reroofed by it, greatly to the comfort of the audience.

How to Purify Salt.

Mr. Samuel F. Garrigues, of Ann Arbor, Mich., an extensive miner, refiner, and operator in salt, says, in relation to the purification of the manufactured salt, and especially in freeing it from the sulphates which operate so injuriously against its use for dairy purposes, the end could be obtained in the most perfect and yet the most simple manner by leaching the salt with a saturated solution of itself. In other words, said he, to purify a barrel of this salt all that you have

near Vienna, on Leopold day. It consists of a cask which, after the occupants have been firmly secured in their places, is rolled about, the women screaming, of course, when they revolve rapidly around the axis of the cask.—*Illustrirte Zeitung.*

Alteration of Water Colors.

After a discussion of the subject in the English Society of Aquarellists, two distinguished physicists, Messrs. Russell and Abbey, were delegated to study the action of light and air upon water colors. After two years of research, these two gentlemen have just rendered their report.

In order to ascertain the action of broad daylight, the experimenters painted strips of Whatman's paper with all colors and various mixtures, and then inclosed them in thin glass tubes, which they fixed against a wall facing the south—some of them exposed to the full light and others covered with an opaque veil. After twenty-one months, the following colors (given in the order of the extent of the alteration) were changed: Carmine, crimson lake, madder red, scarlet lake, Payne's gray, Naples yellow, olive green, indigo, purple madder, gamboge, Vandyke brown, Indian yellow, cadmium yellow, Leitch's blue, violet carmine, purple carmine, sepia, aureoline, rose madder, permanent blue, Antwerp blue, madder lake, vermilion, emerald green, and umber. The following colors remained unaltered: Yellow ocher, Indian red, Venetian red, burnt sienna, chrome yellow, lemon yellow, raw sienna, oxide of chromium, Prussian blue, cobalt,

about two years old in western Pennsylvania, and more than 200,000 acres of land in Washington and adjoining counties have been drilled with gas wells. Nearly 150,000 tons of iron have been used in manufacturing the pipes through which the 500,000,000 cubic feet of gas flows from the region daily to the places using it. Over \$25,000,000 is invested in the business by the fourteen organized companies that produce the bulk of the gas. The land and wells represent an outlay of \$17,000,000. The wells now producing are capable of doubling the quantity now demanded for light and heat. Nearly 2,000 miles of pipes are required for conducting the supply to consumers. It is estimated that the use of natural gas has displaced 25,000 tons of coal daily in western Pennsylvania and eastern Ohio alone. Besides the wells controlled by the gas-producing companies, individual owners have wells for the supply of smaller towns, and every village and hamlet in the region has enough natural gas running to waste every day to abundantly supply the same number of towns of 10,000 inhabitants each with light and fuel.—*Light and Heat.*

Inherited Deficiency of a Tooth.

Dr. Cryer says, in the Philadelphia *Medical Times*, that he has, among his patients, members of the same family, representing five generations, each lacking the left lower lateral incisor tooth. An interesting feature of this remarkable instance of heredity is that one of the members of the same family has a supernumerary lower incisor.

An Electric Mountain Railway.

This has recently been opened to the public at the Burgenstock, near Lucerne. Under the superintendence of M. Abt, the rails describe one grand curve formed upon an angle of 112 degrees, and, by an arrangement of the Abt system, the journey is made as steadily and smoothly as upon any of the straight funicular lines previously constructed. The Burgenstock being almost perpendicular, it would have been impossible to construct a railway upon the old plan. From the shore of the Lake of Lucerne to the Burgenstock is 1,330 feet, and it is 2,860 feet above the level of the sea. The total length of the line is 938 meters, and it commences with a gradient of 32 per cent, which is increased to 58 per cent after the first 400 meters, and this is maintained for the rest of the journey. A single pair of rails is used throughout, with the exception of a few yards at half distance to permit the two cars to pass. Through the opposition of the Swiss government, each car is at the present time only allowed to run the half distance, and they insist upon the passengers changing, in order, as they say, to avoid collision or accident. The motive power, electricity, is generated by two dynamos, each of 25 horse power, which are worked by a water wheel of nominally 125 horse power, erected upon the river Aar at its mouth at Buochs, three miles away. The electric current is conducted by means of insulated copper wires. The loss in transmission is estimated at 25 per cent.

Export Museums in Germany.

The Germans still seem to find their export museums very useful, if one may judge by the increasing number of such institutions, and the care with which they are being developed. These museums are now in existence at Stuttgart, Berlin, Munich, Cologne, Frankfurt, and other places in Germany. With regard to that at Frankfurt, British Consul-General Oppenheimer has recently reported at some length. He states that these export museums are looked upon with growing interest, inasmuch as they "greatly contribute to extend German intercourse with foreign countries."

The Frankfurt Export Museum is said to serve as the means of informing the manufacturers and merchants of the district as to the articles most current abroad, giving them the prices realized, stating the mode of packing most in favor, the quantities sold, the local charges, the period for which credit is asked and given, and so forth. An import museum forms an essential part of the Frankfurt institution, its object being to make manufacturers and merchants acquainted with the raw materials which may be made useful for various technical and industrial purposes. All possible information is given as to these materials. An information office constitutes another part of the Frankfurt Museum. It contains statistics of all kinds, technical and commercial periodicals, reports, particulars of customs tariffs, and so on.

Information, samples, etc., are constantly received by all these museums from the German consulates all over the world. At Frankfurt there are also export sample rooms, where there are exhibited samples, designs, show cards, price lists, etc., giving exact prices, weights, measures, and all other necessary details in German, English, and French.

Thus the Germans appear to cultivate these institutions with care. They do so, it is stated, because they find in them a means of more economical, more permanent, and more effective representation than exhibitions, which involve heavy expenses. In taking this view the Germans are probably right, seeing that the majority of exhibitions are now of no use whatever save as a very expensive means of advertising to the general public. That impression is spreading in this country, but up to the present it cannot be said that there is anything like a general movement in the direction of export museums or sample rooms. Such museums are, perhaps, better fitted for a rising industrial nation like Germany than for Great Britain, yet we should probably be wise not to neglect an idea which appears to be found so useful by those who are undoubtedly our most earnest and most serious commercial competitors.—*The Ironmonger.*

An American Parachutist in England.

On the evening of September 1 Professor Baldwin, the daring American aeronaut, for the tenth time successfully performed his feat of dropping from a balloon at the Alexandra Palace, London, in the presence of many thousands of spectators, among whom were Major Templer, of the Military Ballooning Department, Chatham; Mr. Lefevre, president of the Balloon Society of Great Britain; and others interested scientifically in the question of aerial navigation. The ascent with the balloon was made by Professor Baldwin from the North Park, and he dropped away from the balloon with his patent parachute at an altitude of about 1,200 feet, and safely descended just outside the palace fence on the Wood-green side. The balloon fell at Wood-green. Afterward there was a large gathering of visitors in the central hall of the palace to witness the presentation of a gold medal to Mr. Baldwin by the Balloon Society.

A POCKET CAMERA.

BY GEO. M. HOPKINS.

No equipment for a tour or a summer's vacation is now complete without a photographic outfit for making instantaneous memoranda of scenes and objects met with upon the road, on the river or lake, or in the picturesque nooks of mountain and valley. The principal trouble with photography in these days is not with the plates and chemicals, as of old, but with the more or less cumbersome camera and accessories, which

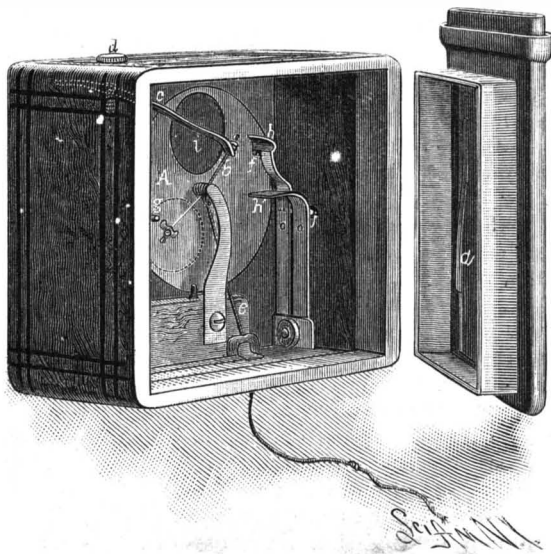

INTERIOR OF POCKET CAMERA.

must be ever present with the artist, making him an object of curiosity wherever he may go.

If large pictures are desired, a large camera and tripod of corresponding size will, of course, be required. To these must be added a complement of plate holders if a number of pictures are to be made in a short time. Some of the recently devised cameras are very portable, and in every way desirable. The writer adds to the list an instrument which differs in some respects from others. The principal feature is the plate-changing device, which is quite simple and admits of the use of flexible bags for holding the plates before and after exposure. The bags—which hold one plate each—are made of the stout black paper known in the trade as leatherette. Each bag has a very thin covering of leather, such as is used by bookbinders on very light work, and around the mouth of the bag is glued a band of thin, tough pasteboard. The bags are made over a wooden form. A dozen filled bags occupy very little more room than the plates in the original package. The light is excluded, and the plates are held in the bags by folding over the top, as shown in the engraving. Each bag is provided with a rubber band extending around it lengthwise, to prevent it from unfolding.

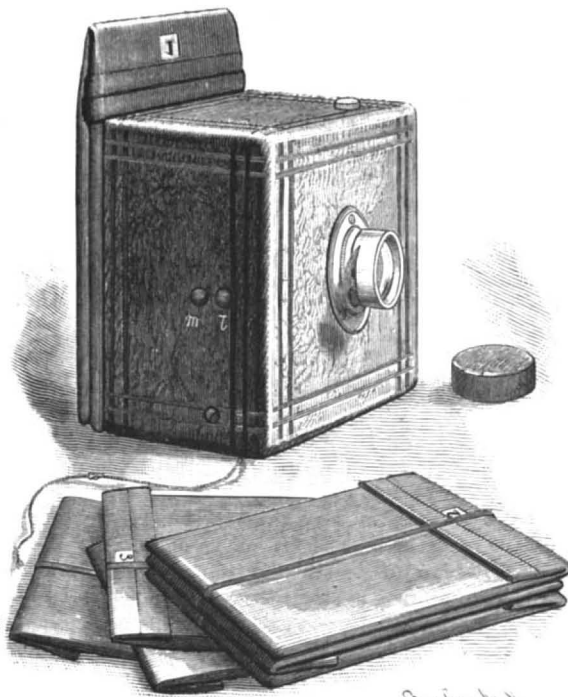

A POCKET CAMERA.

In the present case, the plate holder proper is made of brass and fitted to the camera box, from which it is never removed, except in case of some disarrangement of the interior parts of the camera. The holder consists of a flat sheath, made of suitable size to readily admit the plate, and provided with an opening in the front side, of the size of the field of the lens. This opening is surrounded by a flange which fits light-tight into the camera box.

Two light-bowed springs, *a*, are soldered to the back of the sheath, and tend to press the plate forward to bring the film into the focal plane.

The end of the sheath, which projects upward above the top of the camera box, is of suitable size to be re-

ceived in the stiffened ends of the bags, and a channel is formed around the end of the sheath near its upper end by soldering an angled strip of brass around the mouth of the sheath, as shown in Fig. 1. Into this channel the stiffened end of the bag is inserted before it is unfolded. The channel is blackened, so that when the end of the bag is inserted in it, no light can enter. Now, by straightening the bag and shaking the camera, the plate contained by the bag will be made to fall into the holder. The bag can now be folded against the back of the holder and held there by one of the elastic bands extending over the top and under the bottom of the box. The removal of the plate from the camera is simply the reverse of what has just been described; that is, the bag is unfolded, and the camera being inverted, the plate is dropped into the bag, when the bag is again folded and removed from the holder.

The shutter of this little camera is both simple and effective. It admits of instantaneous and time exposures, and can readily be adjusted to any required speed without opening the camera box.

The shutter consists of a light metallic disk, *A*, provided with a central boss arranged to turn on a stud projecting from a plate secured to the inner surface of the front of the box. A stout but fine cord, *b*, is attached by one end to a small loop soldered to the face of the shutter and wound once around the boss of the shutter; the remaining end passes through a hole in the end of the spring, *c*. A screw, *d*, passes through the top of the camera, through a slot in the spring, *c*, the nut being fitted to the slot of the spring and provided with shoulders which support the spring. By turning the screw, *d*, the spring may be made to turn the shutter with more or less rapidity, as may be required. A cord, *e*, inserted in an eye on the boss of the shutter and wound in a direction opposite that of the cord, *b*, passes out through a hole in the box and serves to set the shutter.

The shutter is provided with two small studs, *f*, *g*, the stud, *f*, being arranged near the periphery of the disk, in position to be engaged by the spring catch, *h*, when the shutter is drawn around by the cord, *e*, preparatory to making an instantaneous exposure. The stud, *g*, is placed in such a position relative to the catch, *h'*, that its engagement with the catch will hold the shutter open, or with its opening, *i*, coincident with the opening of the tube, as indicated in dotted lines.

The catch, *h'*, is provided with a wire arm, *j*, which extends behind the catch, *h*, in such a way as to allow the catch, *h'*, to move a short distance before releasing the catch, *h*. Each catch is provided with a stud which projects through the camera box and presses against the leather covering, forming two small convex projections, *l*, *m*. When an instantaneous exposure is desired, the shutter is released by pressing the projection, *l*. When a time exposure is to be made, the button, *m*, is pressed. This operation first throws the catch, *h'*, into the path of the stud, *g*, thus releasing the stud, *f*, allowing the shutter to turn until the stud, *g*, strikes the catch, *h*. This will arrest the shutter in an open position. When the catch, *h'*, is released, the shutter closes. For time exposures the camera box may be placed on any convenient support.

For instantaneous exposures, the camera may be held in the hand. One desiring to make a camera of this kind, and having the proper facilities, could substitute a toothed sector and pinion for the shutter boss and the cords used in operating it.

The camera lens is of the spherical, wide angle kind, with a fixed focus for all distances from five feet upward.

The camera box is 2 inches deep and 3½ inches square, outside measurement. The camera was designed especially as a tourist's companion for taking lantern views, and it has served its purpose very well indeed.

Hydrogen for Balloons.

While experiments are being made in England to solve the problem of the manufacture of balloon hydrogen by electrolysis, *Iron* informs us that Messrs. Majert and Richter have devised, had constructed, and successfully experimented with, at Berlin, an apparatus that does away with the inconveniences of former processes. The hydrogen is obtained by heating a mixture of slaked lime and powdered zinc, the carriage of which on a campaign is rendered easy by inclosing it in tin cartridges. The water of the slaked lime is decomposed by the zinc, and, as a result, there is obtained a pure gas, free from arseniated hydrogen, which is so dangerous to man, and from sulphuric acid, which is so injurious to the balloon. The apparatus for producing the gas is heated by any combustible whatever. It is in the form of a small locomotive, and is easily drawn by four horses. In front, there is a seat for two men, which can be removed in a minute and be replaced by a chimney. The fire is started, and in six minutes the cartridges are red hot. As soon as this temperature is reached, the cartridges are introduced into the retort, and five minutes afterward the production of hydrogen goes on normally. With 120 cartridges, about 890 cubic feet per hour are obtained. A military balloon of ordinary dimensions can, therefore, be inflated in three hours.—*La Nature.*

The Number of the Stars.

The total number of stars that one can see, says Prof. E. S. Holden, in the August number of the *Century*, will depend very largely upon the clearness of the sky and the keenness of the sight. In the whole celestial sphere, there are about six thousand stars visible to an ordinarily good eye. Of these, however, we can never see more than a fraction at any one time, because a half of the sphere is always below the horizon. If we could see a star in the horizon as easily as in the zenith, a half of the whole number, or 3,000, would be visible on any clear night. But stars near the horizon are seen through so great a thickness of atmosphere as greatly to obscure their light, and only the brightest ones can there be seen. As a result of this observation, it is not likely that more than 2,000 stars can ever be taken in at a single view by any ordinary eye. About 2,000 other stars are so near the south pole that they never rise in our latitudes. Hence, out of 6,000 supposed to be visible, 4,000 only ever come within the range of our vision, unless we make a journey toward the equator.

As telescopic power is increased, we still find stars of fainter and fainter light; but the number cannot go on increasing forever in the same ratio as with the brighter magnitudes, because, if it did, the whole sky would be a blaze of starlight. If telescopes with powers far exceeding our present ones were made, they would no doubt show new stars of twentieth, twenty first, etc., magnitudes; but it is highly probable that the number of such successive orders of stars would not increase in the same ratio as is observed in the eighth, ninth, and tenth magnitudes, for example.

The enormous labor of estimating the number of stars of such classes will long prevent the accumulation of statistics on this question; but this much is certain, that in special regions of the sky that have been searchingly examined by various telescopes of successively increasing apertures, the number of new stars found is by no means in proportion to the increased instrumental power. If this is found to be true elsewhere, the conclusion may be that, after all, the stellar system can be experimentally shown to be of finite extent, and to contain only a finite number of stars.

In the whole sky, an eye of average power will, as above stated, see about 6,000 stars. With a telescope, this number is greatly increased, and the most powerful instrument of modern times will show 60,000,000. Of this number, not one out of 100 has ever been catalogued at all.

In all, 314,926 stars, from the first to the ninth and one-half magnitudes, are contained in the northern sky, or about 600,000 in both hemispheres. All of these can be seen with a three-inch object glass.

Labrador.

Mr. R. F. Holme recently read to the Royal Geographical Society an interesting account of a journey to the interior of Labrador. Although the coast is utterly bare and treeless, a luxurious forest growth commences at a distance inland of about twelve miles, and clothes the whole of the country except the barrens or moors, which are the home of the caribou. Mr. Holme has ascended all the rivers that flow into Hamilton Inlet as far as navigable in a boat. One of the most important of these is the Kenamou, used as one of the routes from the south. By far the largest river of this district is the Grand, which is the name given to the channel connecting Lake Petchikapou with Goose Bay, at the head of Hamilton Inlet. Grand River is really only a portion of a continuous waterway of rivers and lakes connecting Goose Bay with Ungava Bay. Lake Wiminikapou is situated about 150 miles from the mouth of Grand River, and thirty miles above that long and narrow lake are the Grand Falls, the height of which is not known, but which may prove to be among the most stupendous in the world. The elevation of the Labrador table land is given by Professor Hind at 2,240 feet, and at least 2,000 feet of this are in the thirty miles between the head of these falls and the lake below.

Lake Petchikapou, one of the largest of the interior lakes of Eastern Labrador, is connected with the ocean not only by Grand River, but by Nascopee River and Grand Lake. The Indians of the interior of Labrador are all of the Cree nation, and are perhaps the most unadulterated Indians to be found on the continent. A. G. Guillemard, in a note to the May number of the *Proc. Roy. Geog. Soc.*, suggests that possibly the Grand Falls of Grand River (Labrador) might be reached more readily by following up the Moisie River from the Gulf of St. Lawrence and skirting Lake Aswanipi. He also says: "The fall from a height at all approaching 2,000 feet of a river 500 yards in width, a short distance higher up, would form one of the wonders of the world, and would surely have been described by Mr. Maclean after returning from his visit in 1839. Mr. Guillemard mentions among waterfalls combining great volume of water and great height, the Garsoppa Falls, in Western Hindostan, 300 yards wide and 830 feet high, and the Kaieteur Fall of the Potaro River, in British Guiana, 123 yards wide and 741 feet in vertical height.

Horse Railways.

Two distinct methods are recognized among street car men in the handling of their stable equipments. In one the stock of horses is kept as low as possible, they are worked hard, making 14 or 15 miles a day, and the depreciation is very heavy. In the other the stable equipment is increased, the horses are kept in excellent condition, their average daily duty is reduced to 10 or 12 miles, and the depreciation is lessened.

Assuming the cost of a horse as \$150, and the cost of feeding and caring for him as \$180 per annum, it would seem that any accurate knowledge of the average life of horses under different day's duty would soon determine the proper amount of the latter.

All railway returns do not, strange as it may seem, give accurate information on which such estimates of cost can be made, but from such facts as are given we may deduce the following: Taking the returns for 1887 for the five largest roads in Massachusetts, we find that they show 6,909 horses and 1,410 cars, that the mileage made was 12,834,665, and the passengers carried, 76,187,942.

Dividing the average daily mileage by the number of horses, and multiplying the number of horses in a team, we find only 10.26 miles as the average daily duty for all teams, sick or well. Horses which are on duty make from 12 to 14 miles.

On the West End road of Boston, which is now the largest street railway combination in the world, having about 212 miles of track and over 8,000 horses, 10 per cent of the horses are counted as being off duty from illness, sprains, shoeing, or other causes, and the balance of the horses average about 12 miles a day. A car day is estimated at 10 to 11 hours, and from 45 to 50 miles, and eight horses are allowed as the active force.

The rule given me by one of the officials of this company, as a fair one to determine a stable equipment, is to divide the total daily mileage by the miles made in a car day and multiply it by nine, adding what is necessary for hill horses. Hence, if 50 miles is a car day duty, a daily run of 1,600 miles would require a stable equipment of 288 horses besides those for hill work.

On the Fourth Avenue line, in New York, the stable equipment is determined as follows: A car day is 11 hours, and eight horses make about five trips, aggregating about 50 miles. To this number is added 10 per cent for illness, sprains, etc., and 10 per cent for emergencies. On this road is illustrated the influence of an important factor in horse car work—that is, the position of the stables. Horses from the upper stable are limited to 11 miles, or otherwise they would have to make 22 miles, while horses from the lower stable have to make about 13½ miles, or considerably more.

The average cost of motive power per car day throughout the United States, that is, for from 10 to 11 hours and trips aggregating from 45 to 50 miles, is about \$4. This counts only those horses on actual duty on the road. The cost of motive power per car day for equal mileage in Richmond (Richmond Union Passenger Railway, equipped by the Sprague Electric Motor Company) is less than \$2 on the heaviest sort of grade work. The total operating expenses of a horse railway average for the five largest roads in Massachusetts 25.15 cents, and for all the roads in Massachusetts 24.7 cents per car mile, and the ratio of operating expenses to gross receipts is, for all the roads, 86 per cent.

The cost per day per horse, based upon the returns of four of the largest roads in New York, is 54 cents, and the cost per car mile from 9½ to 10½ cents per car mile.

In addition to the regular depreciation, there is ever present danger of an epidemic in hot weather.

Since the cost of the motive power alone—that is, the cost of harness and stable equipments, horse shoeing, renewals, provender, hostlers, etc.—is 40 per cent of the total operating expenses, it will at once be seen how vitally important any material saving in the cost of motive power becomes. If, as we claim, the cost of motive power in an electrical system is one-half or less than that in a horse system, the percentage of gross receipts available for interest and dividends is more than doubled.

Furthermore, when we remember that the average running time for horses is only five to six miles per hour, we have another reason which constitutes an unwarrantable objection to the use of horses for rapid transit.—*Frank J. Sprague.*

The Treatment of Sleeplessness.

Recipes for sleeplessness continue to present themselves. A correspondent of the *Lancet* has found the following to be an effectual remedy in his own case: After taking a deep inspiration he holds his breath till discomfort is felt, then repeats the process a second and a third time. As a rule, this is enough to procure sleep. A slight degree of asphyxia is thus relied on as a soporific agent, but the theoretical correctness of this method is somewhat open to question. Certainly there is proof to show that the daily expenditure of oxygen is most active during the waking period, and that nightly sleep appears to coincide with a period of

deficient tissue oxygenation. It is at least as probable, however, that other influences are associated with the production and timely recurrence of sleep besides that just referred to. This plan, moreover, however effectual and beneficial in the case of its author, is not without its disadvantages. The tendency of deficient oxygenation is to increase blood pressure and to slow the heart's action. With a normal organ, as an occasional occurrence, this might not be of much consequence. If, however, the impeded heart should also be enfeebled by disease, the experiment might be repeated once too often. Another combatant in the struggle with insomnia lays down a series of rules, for the most part very sensible, to which he pins his faith. Considering that the chief causes of sleeplessness are worry and the want of a due amount of exercise and fresh air, he advises his fellow sufferers to observe the ordinary rules of hygiene relating to such matters, to take food and drink in moderation, and to avoid an evening the use of tea, coffee, and tobacco. In dealing with severe nervous irritation from mental or physical work, he has found a daily rest an almost essential prelude to sleep at night. Thus, he treats of sleeplessness rather as a tendency requiring constitutional remedies than a symptom of mere brain excitation. There is much to be said for his theory and means of treatment.—*Therapeutic Gazette.*

Division of Labor.

A new idea has been developed in Germany, in the shape of the manufacture of mortar, to be sold at retail to small builders and private individuals. The business requires very little capital, and the mortar, which is mixed by machinery, and of excellent quality, finds a ready sale, something like two million barrels having been disposed of last year in Berlin alone. It is rapidly becoming usual for city builders here, as elsewhere, instead of maintaining large yards, at enormous rents, for the storage of materials, to keep only an office, contracting for their bricks, lime, cement, doors, lumber, glass, and so on, to be delivered at the building where they are to be used. This involves the manufacture of mortar on the ground, under unfavorable circumstances, and at an unnecessary expense; and a provision by which, on dropping a card into a box or speaking a word through a telephone, a suitable quantity of first-rate mortar for any purpose, ready for use, could be delivered at an hour's notice where required, seems likely to be very useful.—*The Architect.*

While, in the course of time, adds the *Review and Record* (Brooklyn), architects will become divided into men who devote themselves wholly to designing churches, or office buildings, or factories, or residences, no one man attempting to cover the entire field, similar subdivisions will be made in the building trade. We shall have firms supplying mortar only, or cement; others that lay bricks, or certain kinds of stone, or make foundations, or construct roofs; no one man undertaking to do everything himself. And, by the way, the principle does not end with the architect and the builder, but is applicable as well to the trade of the decorator, plumber, plasterer, etc.

Alum Baking Powders.

Mr. C. V. Petraeus, in an article on baking powders in the *Pharmaceutical Record*, states that burnt alum is the most perfect acid element that can be used in baking powders, and for several reasons, viz.: 1. When exposed to the air, it does not become moist. 2. When mixed with bicarbonate of soda, and starch or flour, burnt alum evolves no gas at ordinary temperatures, therefore an alum baking powder does not deteriorate in the package like a cream of tartar powder—its keeping quality is far above the latter. 3. Though burnt alum does not dissolve in water, during the baking process it sets free the gas from bicarbonate of soda slowly, and with greater regularity than cream of tartar, and therefore does much better and more effective work. He shows further that 80 grains of burnt alum decompose as much bicarbonate (84 grains) as 188 grains of cream of tartar, and while the dry residue in the latter case weighs 210 grains, in the case of the alum it is 110 grains (71 grains sulphate of soda, 22 grains sulphate of ammonia, and 17 grains alumina). The use of alum in baking powder must not be confounded with its use for "improving" bad flour. In the one case the alum remains in the bread as alum, just as it was put into the flour; but when mixed with bicarbonate of soda, as in baking powders, it is entirely decomposed, and there remains in the bread only a few grains of insoluble alumina, which is quite as harmless as would be a few grains of white clay or any other inert material. For these and other reasons Mr. Petraeus considers that alum baking powders are the best, not only because a given quantity will raise more bread than the same quantity of cream of tartar baking powder, but because of the small quantity and innocent character of the residue they leave in the bread. A suitable formula for alum baking powder, based on the figures given above, would be as follows:

Burnt alum, in fine powder.....	8 oz.
Bicarbonate of soda.....	8 " 3 liij.
Rice flour.....	1 lb.

—*Chem. and Drug.*

THE GLYPTODON

JOHN R. CORYELL.

The glyptodon (*Glyptodon clavipes*) is the remote and gigantic ancestor of the common South American armadillo, and was, in its day, a relative of the still more gigantic *megatherium*, which, for its part, was the ancestor of the sloth of our time. In other words, the glyptodon belonged to the order Edentata, or toothless animals. It was not, however, strictly speaking, a toothless animal, as its name indicates, it being derived from *glyptos*, fluted, and *odons*, tooth.

In its important external characteristics it was more like the turtle of to-day than the armadillo, for whereas the latter is covered with jointed plates which enable it to roll itself up into a ball-like shape, the glyptodon was covered with one massive and stiff shield or carapace, very similar to that of the turtle. Like the turtle, too, it had the under plate or plastron, a piece of armor which is lacking in the armadillos. It was not, however, in any degree related to the turtle, only exhibiting in a remarkable way the similarity of results produced by similar causes, even when working on totally disconnected objects. In effect the struggle for existence in those distant, formative times produced the sluggish, vegetable-eating, armor-clad glyptodon, just as it did the monstrous land tortoises, fragments of which have been found in India and the islands of the Indian Ocean.

In the turtle and tortoise the carapace is, in fact, the backbone and ribs in itself, whereas in the glyptodon the skeleton is merely hidden under the coat of mail. The backbone of the glyptodon was stiff and immovable except at the neck, where it was jointed, to allow of freedom of action. In this respect it differed from its descendant the armadillo, which has the backbone jointed, in order that it may roll itself up. The glyptodon was too enormous to need to seek safety in such a way as that. It had merely to draw its feet under its shield and settle firmly to the earth. In this position it would have required not only strength beyond any living creature to overturn it, but would have defied any attack that could then have been made upon it.

When standing, it was as large as a rhinoceros and much more bulky. The carapace was seven feet in length, eleven and a half feet along the curve of the back the long way, and nine feet across, following the curve. The shell alone was about three and a half feet high, and to this must be added a foot and a half more for the height of the animal when standing on its feet.

Different portions of the glyptodon and allied species have been found, but only one carapace is in existence, and that is at the Jardin des Plantes in Paris. This and the scattered bones were all found in deposits of the pleistocene age, in the fluvial beds of the Argentine Republic and in the bone caves of Brazil. It is supposed that the glyptodon, together with others of the same order, such as the *megatherium*, the *mylodon*, and *megalonyx*, lived in the wooded uplands drained by the Parana and Uruguay Rivers. At that time the pampas of the La Plata were no more than the submerged deltas of these two rivers, and there were deposited the bones of the monsters drowned by the floods in the upper valleys. And there, too, was deposited the sediment brought down by the rivers, and, so, the pampas of to-day are the illustrated book in which the paleontologist can read the story of the remote past.

The cave was undoubtedly the first home of primitive man, but it has been suggested, with an air of probability, that the idea of the hut was derived from such a source as the discarded carapace of some dead glyptodon. There certainly is no discredit to the theory in the size of the carapace, for it was large enough for the primitive savage with his limited notions of comfort. It would have made, in fact, a sufficient shelter, and that was the most that the savage would have demanded at the first. It is not at all difficult to imagine the comfort with which the first man realized that he had found, ready to his hand, an airtight, rainproof shelter. Such a use of the carapace would in a measure account for the few that have been

found, for, exposed to the action of the elements, as would happen in such a case, the tough shield would eventually crumble into dust, whereas those which were buried in the deposit of the rivers would remain for ages as good as when the animal died, almost.

Natural History Notes.

Cultivation of Lichens.—A very interesting paper has been contributed to the *Transactions* of the Botanic Institute of the Royal Academy at Munster by Mr. Alfred Moeller, in which he demonstrates that, if the spermatia of lichens are placed in a suitable nourishing medium, they can be made to germinate, and that they are consequently spores, and do not correspond to male organs or antheridia. The spermatia of these plants must, therefore, hereafter be regarded rather as analogous to conidia, and as the asexual form of reproduction.

Carrying his researches still further, Mr. Moeller found that by continuing the cultivation, whether from spores or spermatia, a well developed thallus could be obtained in the nutritive medium, he having succeeded in obtaining such of nine species. In one species, *Calicium parietinum*, he obtained also asci and spermatia.

The Buffalo has now become so scarce that the death of one is recorded as a matter of news in the daily papers. A Laurel, Montana, correspondent of the *Forest and Stream* writes that, on July 30, a buffalo bull came within 200 yards of a round-up camp at Rock Creek,

determine the distribution of mineral constituents in trees. Transverse slices, taken at intervals of sixteen feet along the trunk of a beech tree, one hundred and fifty years old, were divided so that each portion corresponded to thirty annual ligneous rings, and these were analyzed. The yield of ash from zones of wood of the same age was found to increase regularly from the base of the trunk to the summit. Passing in from the circumference to the center of a section taken toward the base of the trunk, each successive portion yielded a larger quantity of ash until a certain limit was reached; after which the yield of ash progressively decreased; but the increase in the yield of ash from sections taken higher up the trunk was continuous from the periphery to the center. The composition of the ash also varied, the proportion of potash, which was 23 per cent in that yielded by the outermost portions of the wood, increasing to 43 per cent in the ash yielded by the central portions, while, on the contrary, magnesia fell in going from the circumference to the center from 29 to 11 per cent, phosphoric acid from 8 to 2 per cent, and sulphuric acid in the same direction. The bark was much richer in mineral constituents than the wood, lime being the predominant constituent and forming 82 per cent of the ash.

Preservation of Flowers.—Prof. Fithol describes the following method of preserving flowers: Inclose the flowers, with a little burnt lime, in a tube hermetically sealed. In a few days all the oxygen of the air will have disappeared, the lime will take up some of the moisture of the flowers and portions of the carbonic acid, so that the plant soon exists in pure nitrogen.

The Loco Weed.—No other plant in the flora of Texas has enjoyed a greater notoriety than the famous "loco" or "crazy weed." Popular superstition has accredited it with a most remarkable property, and that is the power of producing insanity in man and beast. Botanically, the plant is known as *Astragalus mollissimus*. The extravagant stories that have been told about it recently led Mr. Jas. Kennedy to investigate its properties and determine what physiological phenomena result from its action.

As the result of his investigations, and his experiments upon animals feeding in pastures, Mr. Kennedy finds conclusively that the plant is non-toxic and innocuous, and possesses none of the properties long ascribed to it by popular superstition. He thinks that the immense destruction of stock with which it has been charged may have been caused by

some poisonous plant heretofore unsuspected, or if the "loco" really has produced death, it has done so by reason of the tough, fibrous, and indigestible character of the plant acting as an irritant, and not as a poison.

Preparation of Fruit Sirups.

Everybody knows, says M. Manche, in the *Archives de Pharmacie*, that sirups prepared from the fresh fruit juices are far preferable to any others; but that these sirups in their fresh state contain a large amount of carbonic acid is usually forgotten. When the process usually in vogue is followed, and sugar is added to the juices in the cold, a liquid is obtained which soon becomes so dense that the acid finds it difficult to make its escape when heat is subsequently applied, and the consequence is foaming, and sometimes a partial caramelizing of the sugar, from the fact that the sirup makes a denser layer at the bottom while the lighter juice is forming on top. To avoid all this, M. Manche recommends that the juice be boiled before any sugar is added, replacing loss from evaporation by distilled water. The result is said to be better in every way.

Deafness Caused by the Electric Light.

A curious phenomenon was recently related by M. D'Arsonval before the French Academy of Medicine. After gazing for a few seconds on an arc light of intense brilliancy, he suddenly became deaf, and remained so for nearly an hour and a half. Surprised and somewhat alarmed in the first instance, but reassured by the disappearance of the symptoms, he repeated the experiment with the same result. When only one eye was exposed to the light, no very marked effect was produced.—*Medical Press and Circular*.

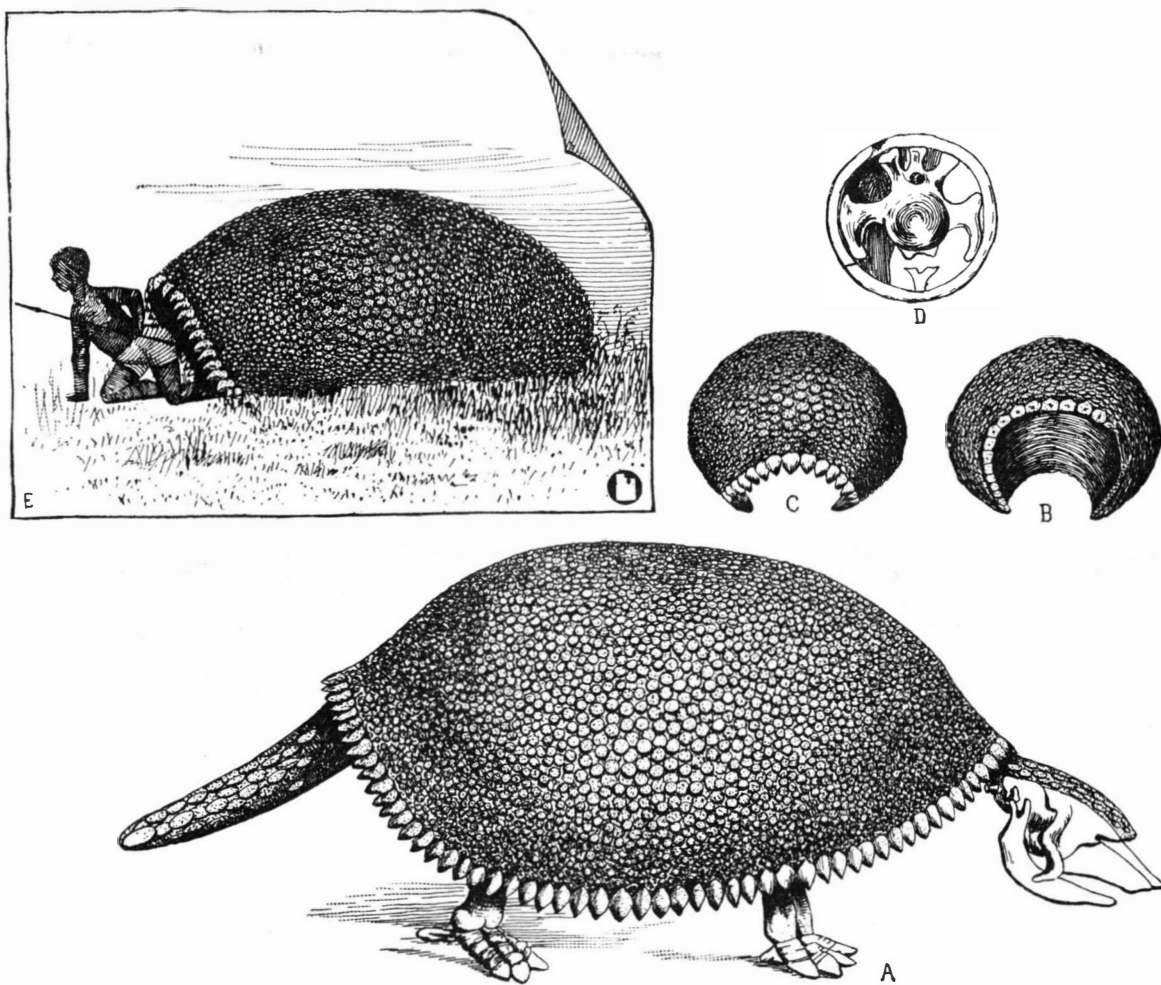

THE GLYPTODON

about thirty miles south of the Yellowstone. Two cowboys at once started in pursuit, armed with revolvers, and after a chase of ten miles brought it down. They brought in the head only. He was so old and thin that even the hide was not worth saving.

Selection of Food by Fungi.—Mr. A. Lister contributes an interesting article to the *Annals of Botany* on the plasmodia of two species of myxomycetes, *Badhamia utricularia* and *Brefeldia maxima*, which he kept under cultivation for twelve months. He finds that the first named fungus exercises a remarkable power of discriminating between different food materials. The fungi which it evidently prefers as food, since it is stimulated by them to greater activity of movement, are *Agaricus campestris*, *Boletus flavus*, and *Stereum hirsutum*, while *Hypholoma fascicularis* was either refused altogether, being left undissolved, or, as in one case, in which the digestion of it seemed to be attempted, the *Badhamia* almost died of indigestion. Starch also, if swollen by moderate heat, was absorbed, and by its stimulant action on the movement of the fungus evidently acted as nourishment. No light, however, was thrown by the experiments on the cause of the rhythmic movements of the plasmodium. The power which the fungus has of apparently communicating information as to the presence of food in contact with a distant part of its network, and of causing a concentration of the plasmodium around and on such food, is extremely remarkable. Light appears to have no influence on the movements of the plasmodium, but lack of moisture causes the plant to assume the condition of sclerotium.

Mineral Constituents of Trees.—An investigation has been undertaken by a German scientist, Mr. Weber, to

ENGINEERING INVENTIONS.

A car coupling has been patented by Mr. Francis M. Rariden, of Waynetown, Ind. The drawhead is provided with a coupling hook and link adjuster, combined with a sliding horizontal shaft having a cross pin and loose notched collar, with other novel features, the coupling being effected without the necessity of the trainmen going between the cars.

A crosshead for steam engines has been patented by Mr. Frank Robb, of St. John's, Mich. It has on each side a bearing made in two parts, one being rigid on the crosshead and the other dovetailed and sliding on the rigid part, with set screws for adjusting the sliding part, being simple in construction and easily adjusted to take up wear on the ways.

An improvement in railway construction has been patented by Mr. Robert P. Faddis, of Socorro, Territory of New Mexico. The invention consists principally in a metallic tie having its ends split longitudinally, one portion being turned up to engage the rail and the other portion adapted for engagement with the stringers by means of stirrups.

A boiler has been patented by Mr. Joseph Leighton, of Reading, Pa. It is especially adapted for rolling mills and similar shops, the invention having for its object to protect the boiler over the neck of the furnace, to increase the heating surface, utilize the products of combustion most efficiently, and introduce heated water to the boiler.

A stake and socket for flat cars has been patented by Mr. Thomas J. Vaughan, of Shawano, Wis. This combined socket and stake is more especially adapted for use on cars employed in the transportation of logs, and provides for the stake being normally held upright, while in unloading it may be conveniently and expeditiously swung downward out of the way.

A switch operating attachment has been patented by Messrs. James P. Tryner and Charles E. Glessner, of Denver, Col. It consists of a bar, with means for moving it transversely to the track, the bar having shoes adapted to engage a projection from the switch tongue, whereby the driver or engineer on a car or locomotive may throw the switch tongue as desired.

An elevated framework and support for electric wires and street railways has been patented by Mr. Linus W. Brown, of New Orleans, La. It has iron cross beams or girders supported by upright iron posts, the latter resting on suitable foundations in the street, the structure to serve as a means whereby street cars may be moved by traction, without putting down surface rails, and to carry any number of electric wires.

AGRICULTURAL INVENTIONS.

A pruning implement has been patented by Mr. Francis A. Hall, of Ennis, Texas. It has a staff or pole which may be made in sections, with jaws which may be operated by sliding a handle up and down on the pole, making a simple and convenient device for pruning trees, shrubbery, etc.

A fruit gatherer has likewise been patented by the same inventor. The pole or staff is similar to that used in the pruner, and there is an attachment for receiving the fruit, consisting of a canvas tube, a metal frame, and an adjustable sleeve.

A rotary harrow has been patented by Mr. Thomas C. Cook, of Rushville, Ind. This invention covers a simple and economical construction which may be conveniently converted from a harrow into a cart, or vice versa, the harrow being readily moved from place to place, or used to carry a load to and from the field.

A cultivator has been patented by Mr. Samuel B. Cunningham, of Iuka, Ark. It has a regulator wheel which may be adjusted to determine the depth to which the plowshare shall cut, and also laterally to serve as a fender, to prevent the crop being covered up by the earth thrown up, being especially designed for use in cultivating young crops.

MISCELLANEOUS INVENTIONS.

A wash stand has been patented by Messrs. Gayger D. Tolman and Lorenzo D. Roberts, of Shawano, Wis. It is a bracket stand adapted to be secured to a wall or similar support, having a folding wash bowl supporting frame and folding pitcher shelf, all adapted to fold up together.

An ironing machine has been patented by Mr. Jean L. Mazoyer, of New York City. The invention covers a novel construction and combination of parts in machines where a heated polishing cylinder moves upon the articles to be ironed while they are held in position upon a bed or table.

A sash fastener has been patented by Mr. Ezra S. Hubbard, of Belmont, Iowa. It consists of a piece of spring wire bent to form a coil and arms, and pivoted on a screw in a recess cut in the face of the sash, by which the sash may be locked when closed or held in any position to which it may be raised.

An ice cream freezer has been patented by Mr. Henson C. Condon, of Rochester, Ind. It consists of a can with a shaft having radial arms upon its opposite sides, one set of radial arms bearing a freely revolving dasher pivoted on an axis parallel with the shaft, and the other set of radial arms bearing a scraper.

A can opener has been patented by Mr. David H. King, of New York City. This invention provides a simple construction of can opener and stove pipe cutter, affording a secure rest for the thumb of the operator, and the easy puncturing of the can or pipe for the insertion of the member having the cutting edge.

A respirator has been patented by Mr. Joseph C. Locke, of An Sable Chasm, N. Y. It consists of tapering tubular perforated shells, to conform to the shape of the user's mouth, and filled with fibrous air-filtering material, in combination with fastening

devices whereby it may be easily and securely applied and readily removed, to secure protection for both the nose and mouth.

A safety device for music boxes has been patented by Mr. Gustave J. Jaccard, of New York City. It consists of a shaft to which is pivoted a pin, a coiled spring for holding the fan closed, with stops for the fan to strike, the device to be applied to the spring barrel of a music box, and to be caused to act by air pressure.

A cigar box trimming machine has been patented by Mr. Henry Leiman, of Brooklyn, N. Y. Combined with a bed having spaced cutters, is another bed having cutters projecting through its bottom, abrading rollers, and other novel features, whereby the box, when nailed together, may be placed in the machine and the edges automatically trimmed and finished.

A permutation lock has been patented by Mr. Charles Hill, of Los Angeles, Cal. This invention covers a novel construction and combination of parts in a safe lock in which all danger is obviated of turning on the full combination by any one who meddles with the knob, as the knob is wholly disconnected from the tumblers of the lock, with various other novel features.

A bake pan has been patented by Bettie H. Bicknell, of London, Tenn. This invention embraces an improved cover consisting of an inverted pan and an outer band or box united at its lower end to the inverted pan, forming an intermediate water chamber or receptacle, to avoid the necessity of boiling meats or fowls before baking, and better retaining their juices and flavors.

SCIENTIFIC AMERICAN
BUILDING EDITION.

OCTOBER NUMBER.—(No. 36.)

TABLE OF CONTENTS.

1. Elegant plate, in colors, of a suburban dwelling costing eight thousand five hundred dollars. Floor plans, sheet of details, etc.
2. Elegant plate, in colors, of two cottages costing twelve hundred and sixteen hundred dollars, respectively. Sheet of details, floor plans, etc.
3. A residence at Richmond Hill, N. Y., lately built, at a cost of ten thousand dollars. Perspective and floor plans.
4. A dwelling for three thousand five hundred dollars. Floor plans and perspective.
5. Villa at Fontainebleau—M. E. Brunnarius, architect. Cost, eight thousand six hundred dollars. Floor plans and perspective.
6. View of the new Protestant church at Lyons, France. Cost, eighty thousand dollars.
7. Page of engravings showing the house at Stratford-on-Avon in which Shakespeare was born—Anne Hathaway's cottage, near Stratford-on-Avon—Trinity Church, Stratford-on-Avon, where Shakespeare is buried—The residence of Mary Arden, the mother of Shakespeare—Old Elizabethan house, Stratford, showing the domestic architecture of the time of Shakespeare.
8. The chancel, Holy Trinity Church, Stratford-on-Avon, showing the Shakespeare memorial bust and tablet, and the stained glass window, the gift of American visitors.
9. A suburban villa lately built at Sound View Hill, Long Island Sound, near New York. Perspective view and floor plans. Cost, five thousand eight hundred dollars.
10. Design for a cottage by S. W. Whittemore, architect, Brick Church, N. J. Perspective and floor plans. Cost, three thousand five hundred dollars.
11. A Queen Anne cottage in Rochelle Park, New Rochelle, N. Y., costing five thousand six hundred dollars. Plans and perspective.
12. An English double house of moderate cost. Perspective and floor plans.
13. Design for the Duquesne Club House, by Heins & La Farge, architects, New York.
14. Miscellaneous contents: A new regimental armory, New York City.—Ventilating pipes.—National Zoological Park.—Lime from oyster shells, showing pit for burning shells.—Roman road construction.—Beauty of the larch.—Sewage disposal in Great Britain.—Orchids, illustrated.—Test of fire-proof wire lathing.—A clematis porch illustrated.—Some ways of using the Virginia creeper, illustrated with 3 figures.—Feeding coal to the fire.—Wood that will not blaze.—Fall of a stone church tower.—A ruined city in Texas.—Loofah as a substitute for sponge.—A California farm.—Defects in plumbing in the Maine Insane Asylum.—An improved reversible shaper, illustrated.—Improved hand and foot power saws, illustrated.—Practical hints on disinfection.

The Scientific American Architects and Builders Edition is issued monthly. \$2.50 a year. Single copies, 25 cents. Forty large quarto pages, equal to about two hundred ordinary book pages; forming, practically, a large and splendid MAGAZINE OF ARCHITECTURE, richly adorned with elegant plates in colors and with fine engravings, illustrating the most interesting examples of Modern Architectural Construction and allied subjects.

The Fullness, Richness, Cheapness, and Convenience of this work have won for it the LARGEST CIRCULATION of any Architectural publication in the world. Sold by all newsdealers.

MUNN & CO., PUBLISHERS,
361 Broadway, New York.

Business and Personal.

The charge for insertion under this head is One Dollar a line for each insertion; about eight words to a line. Advertisements must be received at publication office as early as Thursday morning to appear in next issue.

Patent for improved saw buck, No. 371,188, for sale. Address B. A. French, Pawtucket, R. I.

For Sale Cheap—A Springfield gas machine. About 500 burners. Address P. O. box 1094, New York.

A company having factory well fitted for manufacturing hardware specialties, tools, etc., desires some lately patented article to make on orders or on royalty. Address A. S. C., P. O. box 1748, New York.

Just Published—Elements of Electric Lighting, including electric generation, measurement, storage, and distribution. By Phillip Atkinson, A.M., Ph.D., author of Elements of Static Electricity. 250 pages; 104 illustrations. Price, \$1.50. For sale by Munn & Co., 361 Broadway, New York.

Mechanical drawing, calculations, etc., taught by correspondence. I. Donald Boyer, Dayton, Ohio.

Iron Planer, Lathe, Drill, and other machine tools of modern design. New Haven Mfg. Co., New Haven, Conn.

Pratt & Letchworth, Buffalo, N. Y., solicit correspondence relative to manufacturing specialties requiring malleable gray iron, brass, or steel castings.

Supplement Catalogue.—Persons in pursuit of information of any special engineering, mechanical, or scientific subject, can have catalogue of contents of the SCIENTIFIC AMERICAN SUPPLEMENT sent to them free. The SUPPLEMENT contains lengthy articles embracing the whole range of engineering, mechanics, and physical science. Address Munn & Co., Publishers, New York.

For the latest improved diamond prospecting drills, address the M. C. Bullock Mfg. Co., Chicago, Ill.

Nickel Plating.—Manufacturers of pure nickel anodes, pure nickel salts, polishing compositions, etc. \$100 "Little Wonder." A perfect Electro Plating Machine. Agents of the new Dip Lacquer Kristaline. Complete outfit for plating, etc. Hanson, Van Winkle & Co., Newark, N. J., and 92 and 94 Liberty St., New York.

Wanted.—To buy the patents or the right to manufacture the following articles: A Spring or Compressed Air Motor, a Pop Safety Valve and Steam Injector. Address Holland & Thompson, St. Paul, Minn.

Perforated metals of all kinds for all purposes. The Robert Aitchison Perforated Metal Co., Chicago, Ill.

Link Belting and Wheels. Link Belt M. Co., Chicago.

Presses & Dies. Ferracute Mach. Co., Bridgeton, N. J. The Holly Manufacturing Co., of Lockport, N. Y., will send their pamphlet, describing water works machinery, and containing reports of tests, on application.

Lockwood's Dictionary of Terms used in the practice of Mechanical Engineering, embracing those current in the drawing office, pattern shop, foundry, fitting, turning, smith's and boiler shop, etc., comprising over 6,000 definitions. Edited by a foreman patternmaker. 1888. Price, \$3.00. For sale by Munn & Co., 361 Broadway, New York.

Patents Bought & Sold. H. W. Booth & Co., Detroit, Mich.

Wrinkles and Recipes.—Compiled from the SCIENTIFIC AMERICAN. A collection of practical suggestions, processes, and directions for the mechanic, the engineer the farmer, and the housekeeper. Illustrated colored frontispiece. Edited by Park Benjamin, Ph.D. Third edition. Price, \$2.00. For sale by Munn & Co., 361 Broadway, New York.

Duplex Steam Pumps. Volker & Felthousen Co., Buffalo, N. Y.

Iron, Steel, and Copper Drop Forgings of every description. Billings & Spencer Co., Hartford, Conn.

Steam Hammers, Improved Hydraulic Jacks, and Tube Expanders. R. Dudgeon, 24 Columbia St., New York.

Veneer machines, with latest improvements. Farrell Dry Mach. Co., Ansonia, Conn. Send for circular.

"How to Keep Boilers Clean." Send your address for free 88 page book. Jas. C. Hotchkiss, 120 Liberty St., N. Y.

The best Coffee roasters, coolers, stoners, separators, polishers, scourers, glossing apparatus, milling and peaberry machines; also rice and macaroni machinery, are built by The Hungerford Co., 69 Cortlandt St., N. Y.

No. 11 planer and matcher. All kinds of woodworking machinery. C. B. Rogers & Co., Norwich, Conn.

"New Drill Chuck," holding straight taper or square shanks. Address Standard Tool Co., Cleveland, O., mfrs. of twist drills, reamers, and special tools.

Split Pulleys at low prices, and of same strength and appearance as Whole Pulleys. Yocum & Son's Shafting Works, Drinker St., Philadelphia, Pa.

Safety Elevators, steam and belt power; quick and smooth. The D. Frisbie Co., 112 Liberty St., New York.

Send for new and complete catalogue of Scientific and other Books for sale by Munn & Co., 361 Broadway, New York. Free on application.

NEW BOOKS AND PUBLICATIONS.

AMERICAN COLLEGE MANUAL. By C. Powell Karr. New York: W. T. Coinstock. Price 25 cents.

This is a pamphlet giving information about 74 of the leading colleges and universities of the United States and Canada, the courses of study, professors, requirements of admission, text books used, etc.

DESIGNS FOR SCHOOL HOUSES. Published by the Department of Public Instruction of the State of New York, Albany, N. Y.

This book contains nineteen different designs for school houses, with plans and specifications, and papers on school house grounds, ventilation, outbuildings, blackboards, school desks, etc. The designs are those accepted in a prize competition authorized by the legislature, with the view of increasing the proportion of attractive and comfortable low-priced school houses in the State, especially in the country districts. The State Superintendent of Public Instruction, A. S. Draper, under whose supervision the work is published, has endeavored to show to country school trustees, and others having such work in charge, just how to do a good thing in the way of providing neat and wholesome buildings for public school purposes.

GREAT EARTHQUAKES: THEIR HISTORY, PHENOMENA AND CAUSES. By Wirt Arlaud (A. S. Hooker). New York: W. Carlton Regand. 1887. Pp. xxxii, 600. Price \$1.50.

This work describes, in popular form, a number of the great earthquakes of the world. The famous Peruvian earthquake at Arica, in which the United States steamer Wateree was carried ashore by the tidal wave, is first described, and then, beginning with the marine records of South America, the history is brought down to the present day and to more familiar regions. The records of 1638 in New England, those of 1811 in the Mississippi valley, and those of Great Britain all receive due attention. In this way the whole world is traversed until the recent disaster of Charleston is reached. To this a number of chapters are devoted, describing in great detail all the features of the occurrence. The last six chapters are devoted to the causes of earthquakes, protection of life, volcanic action, external influences, and earth movements in general.

STEAM BOILERS: A PRACTICAL TREATISE ON BOILER CONSTRUCTION AND EXAMINATION. For the use of practical boiler makers, boiler users, and inspectors, and embracing in plain figures all the calculations necessary in designing and classifying steam boilers. By Joshua Rose, M.E., author of "Modern Steam Engines," "The Complete Practical Machinist," "Mechanical Drawing," "The Slide Valve." Illustrated by 73 engravings. Philadelphia: Henry Carey Baird & Co., industrial publishers, booksellers, and importers, 810 Walnut Street, London: Sampson Low, Marston, Searle & Rivington, Limited, St. Dunstan's House, Fetter Lane, Fleet Street, E. C. 1888. Pp. xvi, 250. Price \$2.50.

This work by the eminent engineer is devoted to the practical art of boiler construction. It is adapted for use by the actual constructor, as the cylindrical shell of a circular boiler, its strength, reduction of strength by riveted seams, and the spacing of rivets and all points connected therewith are treated. The strength of riveted joints is next considered, and next the method of calculating working pressures for boilers. Leaving the realm of calculation, attention is now given to experiments on the strength of riveted joints, of stayed flat surfaces, and furnace sheets. The calculations for a modern high pressure marine boiler are then given, followed by a draught of a specification for the same. Stationary and locomotive boilers are treated, the rules of the British Board of Trade and of the United States government for the inspection of steam boilers are given in detail, and the final section is devoted to useful tables. The very practical nature of the book, its classified contents, and very full index make it a work of standard value, and one which will always be in demand by the steam constructor. It is illustrated with upward of seventy cuts.

THE AMERICAN STEAM ENGINEER, THEORETICAL AND PRACTICAL. With examples of the latest and most approved American practice in the design and construction of steam engines and boilers of every description. For the use of engineers, machinists, boiler makers, and students. By Emory Edwards, M.E. Illustrated by seventy-seven engravings. Philadelphia: Henry Carey Baird & Co., industrial publishers, booksellers and importers, No. 810 Walnut Street, London: Sampson Low, Marston, Searle & Rivington, Limited, St. Dunstan's House, Fetter Lane, Fleet St. 18:8. Pp. xxi, 419. Price \$2.50.

Boiler construction, the theory of the steam engine, economy in combustion of fuel, are all treated in this work. In the details of engineering practice the proportions of slide valves and ports, valve motions, slide valve setting, and the general proportions of engines and boilers are carefully considered. The United States regulations for steam boilers are given, and rules for calculating the sizes of compound engine cylinders for given horse power and logarithmic methods for finding the mean steam pressure follow. Special forms of engines are then considered, such as the Trenton steam engine, the improved Corliss engine, the Green automatic cut-off engine, and agricultural engines. Steam yachts and launches receive due attention, and in the appendix practical directions for boiler fitting, counteracting foaming in boilers, polishing metals, belting, etc., are given in detail. The 77 engravings illustrate excellently the topics of the text, and a very full index completes the work.

GRASSES OF NORTH AMERICA, FOR FARMERS AND STUDENTS. By W. J. Beal, M.A., M.Sc., Ph.D. Published and copyrighted by the author. P. O. Agricultural College, Mich. 1887. Lansing. Pp. xiii, 457. Price \$2.50.

In this work the subject of grasses is elaborately treated. The structure, form, and development of the family are described, and then a chapter follows which is devoted to the much discussed subject of the power of motion in plants. After some chapters on plant growth and methods of classifying, collecting, and studying grasses, the subjects of lands for grazing and grasses for cultivation are treated at considerable length. Over thirty varieties of grasses are described in detail. Early attempts to cultivate grasses, methods of testing seeds, preparation of the soil, the care of grass lands when once under cultivation, how to make hay, improvement of present grasses and the search for better ones, are the subjects next spoken of. Departing from the strict subject of the work, the pulse family, including the clover, the vetch, and other leguminosae, are spoken of in a special chapter. Then the enemies of grasses and clovers, including animals and insects, are given a chapter, while a final chapter is de-

voted to the fungi of forage plants. Several pages are devoted to the bibliography of the subject, 175 cuts are contained in the text, while an adequate index terminates the work.

ECLECTIC PHYSICAL GEOGRAPHY. By Russell Hinman. Cincinnati and New York: Van Antwerp, Bragg & Co. Pp. vi, 382. Price \$1.

The general subjects of physical geography, the earth, the atmosphere, the sea, the land, weather and climate, the various forms of life and its distribution, are well treated in this little work. It is illustrated by maps, charts, and general illustrations, amounting to 149, and presents a very attractive appearance. It is designed largely for educational purposes, but can be read with benefit by many long out of school, as giving an abstract of the present treatment of this subject. It is supplied with an index.

STUDIES IN CRITICISM. By Florence Trail. New York: Worthington Company, 747 Broadway. Pp. 328.

Our limitations do not permit us to give any idea of this work. Literature, religion, genius, morality, and art are all treated in it. It displays great merit, and one of our objects in saying so little about it is that no adequate notice can be contained in anything like the space at our disposal.

ENTOMOLOGY FOR BEGINNERS, FOR THE USE OF YOUNG FOLKS, FRUIT GROWERS, FARMERS, AND GARDENERS. By A. S. Packard, M.D., Ph.D. New York: Henry Holt & Company. 1888. Pp. xvi, 367.

This work, although the title states it to be for "young folks, fruit growers," etc., is really, so far as the limits of its size permit, a full treatise on general entomology. The structure of insects, their actions, and the performance of the general functions of life are given elaborately, together with their growth and metamorphosis. Their classification follows, being preceded by a synopsis and tabular view of the orders. Insect architecture and the insects injurious and beneficial to agriculture are next spoken of. A large portion of the work, including about one hundred pages, is devoted to directions for collecting, preserving and rearing insects, their dissection, and to the cutting and mounting of sections. This represents a somewhat neglected subject, for a treatise on which a demand has long existed. The entomologist's library is systematically treated, the bibliography being divided into classes. A glossary and index close the work, which is illustrated by nearly 300 cuts.

Notes & Queries

HINTS TO CORRESPONDENTS.

Names and Address must accompany all letters, or no attention will be paid thereto. This is for our information, and not for publication. References to former articles or answers should give date of paper and page or number of question. Inquiries not answered in reasonable time should be repeated; correspondents will bear in mind that some answers require not a little research, and, though we endeavor to reply to all, either by letter or in this department, each must take his turn. Special Written Information on matters of personal rather than general interest cannot be expected without remuneration. Scientific American Supplements referred to may be had at the office. Price 10 cents each. Books referred to promptly supplied on receipt of price. Minerals sent for examination should be distinctly marked or labeled.

(1) E. J. B.—Powers & Weightman, of Philadelphia, are the only makers of quinine in quantity in this country, and are probably the largest manufacturers in the world.

(2) M. L. W. asks: Whether a driven well (small iron tube), with a force pump, can be used where you have to go down 40 feet for water? A. As ordinarily constructed, it could not. By digging down at the surface so as to have your pump cylinder fifteen feet from the surface, water could be pumped from it.

(3) E. H. B.—To bleach ivory handles of steel tools, protect the steel with a coat of wax or paraffin, and set the handles in a solution of chloride of lime 1 part, water 4 parts, for a day, more or less, then wash the handles with clean warm water, wipe and dry. If satisfactory, warm the metal part and wipe off the wax or paraffin. Another way is to dip the handle in a saturated solution of alum in water for from 1 to 3 hours, wash, wipe, and dry. If the handles are not very dark, the latter way is preferable. For polishing the steel points, use putty powder (oxide of tin) on a buff wheel wet with alcohol. This will not stain the handles.

(4) A. S. M. asks how to restore daguerreotypes. A. Daguerreotypes do not fade, but become stained if much exposed to air and dampness. Probably yours are stained. To clean daguerreotypes according to P. C. Duchochois, take hold of the daguerreotype with pinchers by one corner, and, keeping the plate level, cover it with a solution of potassium cyanide (one part to twenty-five of water), and if the picture be much stained, heat it moderately with an alcohol lamp for fifteen or twenty seconds, when the solution is thrown off and the plate rinsed. This done, flow the plate with clear water, heat it as before, and holding it then almost vertically, dry it; in commencing, heat it at one of the upper corners and dry the water by blowing upon it toward the opposite corner. The whole operation should be quickly done, and the plate not too strongly heated, especially when covered with cyanide, otherwise the image might be obliterated. The daguerreotypes may be dusted with a fine camel's hair brush, but not touched with the fingers nor rubbed with any hard material. They are very easily scratched. They may be copied in the camera, but every precau-

tion should be made to have every object in front of the daguerreotype covered with black to avoid reflections. The camera box and tripod, as well as the lens tube, should be protected with a black cloth.

(5) M. H. F. asks for a formula of a hydrokinone developer:

- No. 1. Water..... 10 oz. Sulphite sodium crystals chem. pure... 2 oz. Hydrokinone..... 1 oz.

Dissolve in the order named, using, if possible, distilled water. This solution should be kept in a yellow bottle or in a dark place. It will retain its strength for a year or more.

- No. 2. Water..... 10 oz. Carbonate of potash..... 2 oz. Carbonate of soda..... 1 oz.

The weights are based on 437 grains to the ounce. Put in the graduate two drachms of No. 1 and one and a half drachms of No. 2, then fill up to three ounces with water. If the developer works too slowly, add one drachm additional of No. 2. This will develop several plates in succession. When through, pour the developer into a separate bottle, filtering it through cotton, and preserve for use on future plates, adding a little fresh developer to it.

(6) J. R.—For oxidizing silver. Dip the clean silver article in a solution of sulphide of potassium (liver of sulphur), 2 drachms to a pint of water. Heat this solution to a temperature of 175° Fah. Immerse for a few seconds only. When the article becomes blue black. For a velvet black, dip the article, previous to oxidizing, in a solution of mercurous nitrate and water and rinse. Then dip in the sulphide solution as above. For a brown shade, oxidize in the potassium sulphide as above, then dip in a liquid composed of 10 parts blue vitriol and 5 parts salamoniac to 100 parts vinegar. After oxidation brush with a scratch brush very lightly, to brighten and variegate the surface. For other methods and further details, see "Techno-Chemical Receipt Book," which we can furnish for \$2.

(7) A. C. W. asks: Whether there is or is not a theory explaining the elliptical orbits of the planets. A. You will find articles in SCIENTIFIC AMERICAN SUPPLEMENT, Nos. 226, 267, 573, on planets, their orbits, and theory of formation. Also see "Newcomb's Popular Astronomy," which we can mail for \$2.50.

(8) F. B. S. writes: I have made a small furnace for melting cast iron on the forge to blow with the bellows, and have had no trouble whatever in melting the iron. Can melt 20 lb. in 20 minutes, and it takes about 20 minutes to get the furnace hot. I have succeeded easily in making small, light castings, but cannot make a thick, chunky casting like a post maul or a dumb bell without leaving a sunk hole in the upper side. The mould fills up all right, but sinks down afterward. I use all scrap iron, and swing the furnace off by a crane, and pour directly from furnace into mould. Can you suggest a remedy? I am a long way from any foundry. A. Make what foundry men call a riser at the highest points in the flask, to carry off air quickly and allow a surplus of metal to flow up, and from which the shrinkage takes metal to fill. It is made like the gate or sprue that you pour into. For a dumb bell you should have two, about 3/4 in. diameter. Possibly you do not have the cope or top part of the flask deep enough to give pressure to the metal. The mouth of the gate should be 3 or 4 inches above the top of the pattern. You will gain much valuable information from "American Foundry Practice," by West, which we can mail for \$2.50.

(9) S. L. P.—You cannot anneal wire practically and satisfactorily by electricity. The cheapest way is to anneal the whole bundle in an oven or muffle at a very low red heat, so as not to burn the outside layers, as is done at the wire works. If the wire is very small, passing it through a red hot muffle or iron pipe from the reel, or the flame of a series of flat wick lamps, would accomplish your purpose. The new lead plating is called kalamein. It is the tinning process, with a mixture of lead and tin, or solder; about 2 parts lead to 1 part tin.

(10) L. R. D.—Lightning rods well grounded are a protection. Ground bone is applied directly to the soil, being sown broadcast like grass seed. 500 to 1,000 lb. per acre may be used. Sometimes it is mixed with wood ashes, 15 to 30 bushels of the latter being applied per acre.

(11) E. M. C. asks: Is there any rule or table printed by which I can calculate the size of wire for the field magnets and armature of a dynamo to properly run a lamp or set of lamps 42 volts 1.3 amperes 16 C. P. A. We refer you for general points of dynamo construction to Silvanus Thompson's Dynamo-Electric Machinery, \$5. The subject of dynamo construction still has to be treated empirically, no final formula having been deduced.

(12) J. S. J. writes: I see in SCIENTIFIC AMERICAN of September 1 an article on vegetable wax. Can you state in your correspondence column what color the wax is, and the price in this country? A. Vegetable waxes resemble beeswax, but are rather lighter in color. There are many kinds. Japan wax sells for 25 cents a pound.

(13) G. L. asks (1) for a method of preparing cider, so it will remain sweet. A. Dip a stick in melted sulphur, set it on fire and hold in a half filled barrel; then agitate it and complete filling. 2. A furniture polish, suitable for hard oil finish. A. Melt beeswax and add turpentine until it possesses the consistency of honey on cooling. Apply with a rag, and plenty of rubbing.

(14) M. J. S. writes: Works on chemistry state that: It has been estimated that a liter of hydrogen or any other gas contains 10²⁴ molecules. Please tell me how the above is shown or where I can find the information. A. You will find the subject treated in the appendix to Thompson & Tait's Physics. Also in the article "Atoms," by J. Clerk-Maxwell, in the En-

cylopædia Britannica, 9th edition. The size is deduced from the electric relations of zinc and copper, from the thickness of soap bubble films, and from the variations from Boyle's law shown by gases.

(15) G. W. O. asks for the process of refining tin and lead, as he has to make a quantity of solder in his business. A. You probably melt your metals at too high a temperature. Keep the heat low and spread some powdered charcoal over the surface.

(16) L. S. asks: What is the most simple, economical and practical way of opaueing the backgrounds on negatives of furniture so as give prints showing only the object on the clear paper? A. We have successfully opaueed negatives with a brush, using Gihon's specially prepared opaue, which can be had from dealers in photographic materials. It dries quickly and flows readily from a very fine camel's hair brush. To get a white background when making the photograph, cover the wall and floor with white sheets, calcimined with lime, then use a magnesium flash light to illuminate the shadows. In this way the furniture will appear clear cut as desired, and it is much easier than using opaue. Also use plates with creamy thick films and of ordinary sensitiveness.

(17) J. S. asks for a corn plaster such as are sold in drug stores. A. Spread common adhesive plaster upon buckskin, cut into disks and punch circular holes in each. For plaster use 1 part isinglass, water 10 parts, tincture of benzoin 2 parts, apply in one or more coats, allowing it to dry between applications.

TO INVENTORS. An experience of forty years, and the preparation of more than one hundred thousand applications for patents at home and abroad, enable us to understand the laws and practice on both continents, and to possess unequalled facilities for procuring patents everywhere. A synopsis of the patent laws of the United States and all foreign countries may be had on application, and persons contemplating the securing of patents, either at home or abroad, are invited to write to this office for prices, which are low, in accordance with the times and our extensive facilities for conducting the business. Address MUNN & CO., office SCIENTIFIC AMERICAN, 361 Broadway, New York.

INDEX OF INVENTIONS For which Letters Patent of the United States were Granted September 25, 1888, AND EACH BEARING THAT DATE.

[See note at end of list about copies of these patents.]

Table listing inventions with patent numbers and dates. Includes items like Air feeder, Alarm, Alloys, Animal trap, Armature, Axle box, Axle lubricator, Axle skein, Bait spoon, Band cutter, Barber's chair, Barometers, Battery, Binding strap, Bleaching fiber, Bleaching wax, Block, Board, Boat, Boiler, Boiler tube cleaner, Book leveler, Book, receipt and record, Book rest, Books, binding clamp, Bottle, Bottles, capsule for, Box, Brake, Brick machine, Bridge, Broom or brush, Brush, Buckle or clasp, Building block or brick, Buildings, waterproof structure, Buggy top, Buoy, Burner, Button making machine, Can heading machine, Can opener, Cant hook, Car coupling, Car coupling, F. M. Rariden, Car gate, Car heaters, Car spring, Car warmer, Cars, metallic platform, Cars, safety brake, Cars, stake and socket, Carburetor, Card flats, Carding machines, Carriage warmer, Carriages, making body loops, Carrier, Cartridge loading machine, Cartridge shell, Case, Catheter, Centerboard for vessels.

Table listing inventions with patent numbers and dates. Includes items like Chain links, Chair, Check or card case, Chopper, Churn, Cigar cutter, Cigar machine, Cigar making machine, Cigar wrappers, Cigar wrapping and finishing machine, Cigarette, Cigarettes with tobacco wrappers, Clamp, Cleaner, Clevis, plow, Clock key, Cloth cutting apparatus, Clothes drier, Clutch for working drills, Clutch, spiral friction, Coffee mill, Cork extractor, Cork extractor, C. & E. H. Morgan, Corn drill, Corset, Corset, J. E. Wood, Cotton chopper, Coupling, Crutch attachment, Cuff holder, Cultivator, Cultivator and harrow, Cutter, Date indicator, Digger, Door securer, Draught regulator, Drier, Drill, Drilling machine, Drum, heating, Dust collector, Dust pan, Dynamometrical governor, Eaves trough hanger, Electric current indicator, Electric currents, registering meter, Electric energy, system for the distribution of, Electric machine, dynamo, Electric motor, Electric storage system, Electric wires and street railways, Electrical conductor and insulating conduit, Elevator, Elevator, C. R. Otis, Elevator safety device, Embossing machine, Engine, Engines, cross head for steam, Engines, igniting apparatus for gas or oil motor, Extractor, Fanning mill, Farm gate, Feed water heater, Felt goods, device for hardening, Fence, Fence tightener, Fender and andiron, Fifth wheel, File, bill and letter, File cutting machine, Filter, oil, Fire alarm, Fire extinguisher for the stoves of railway cars, Fireplace and damper, Fire screen, Floor clamp, Folding table, Frame, Fruit box, Fruit gatherer, Fuel, apparatus for burning liquid, Furnace, Galvanometer, Garment stay, Garment supporter, Gas burner, Gas governor or pressure regulator, Gas incandescents, manufacture of, Gate, Gate, W. P. Elliott, Gate, D. E. Heilton, Gearing, Grader, Grain separator, Grate, Guard, Gun, automatic machine, Gun, magazine, Hanger, Harness trimming, Harrow and pulverizer, Harrow, rotary, Harrow tooth, Harvester, Harvester platforms, Hat conformator and stretcher, Hat Lyons, Hat sweat band, Hay loader, Head rest, Heater, Heating apparatus, Heating device, Heel filing machine, Hinge, spring, Holder, Holder, Paper roll holder, Rein holder, Sash holder, Stovepipe and collar holder, Weather-board holder, Hot air and hot water heater, combined, Hot air and hot water heater, combined, D. S. Richardson.

Hot air furnace, C. H. White..... 390,107
Hydraulic motor, N. E. Harris..... 390,077
Ice cream freezer, H. C. Condon..... 390,002
Indicator. See Date indicator. Electric current indicator.

Skate, J. P. Becker, Jr..... 389,998
Sled, K. Wenzel..... 390,048
Sled, bob, T. G. Mandt..... 390,088
Sleigh, A. Berry..... 389,869
Smoke consumer, G. F. Tinkham..... 390,193
Snow guard or fender, A. H. Bower..... 390,061
Soap receptacle, M. V. Koelsch..... 389,930
Soldering tool, C. L. Wagandt..... 390,045
Spark extinguisher and smoke purifier, T. W. Barnes..... 389,916
Spoke socket, G. W. Steele..... 390,144
Spring. See Car spring. Vehicle spring.

Advertisements.
Inside Page, each insertion --- 75 cents a line.
Back Page, each insertion --- \$1.00 a line.
The above are charges per agate line--about eight words per line. This notice shows the width of the line, and is set in agate type.

Patent Foot Power Machinery. Complete Outfits. Wood or Metal workers without steam power, can successfully compete with the large shops, by using our New LA BOR SAVING Machinery latest and most improved for practical shop use, also for Industrial Schools, Home Training, etc. Catalogue free. Seneca Falls Mfg. Co. 686 Water Street, Seneca Falls, N. Y.

SEBASTIAN, MAY & CO'S Improved Screw Cutting Foot & Power LATHES \$60
Drill Presses, Chucks, Drills, Dogs, and machinists' and amateurs' outfits. Lathes on trial. Catalogues mailed on application. 165 W. 2d St., Cincinnati, O.

FOR SALE! THE FACTORIES OF THE HAMPDEN WATCH CO. AT SPRINGFIELD, MASS.,
Covering about one acre of ground, with Engine, Boiler, Shafting, etc., ready for immediate occupancy for light manufacturing. Address Chas. D. Root, Pres., Springfield, Mass., or Hampden Watch Co., Canton, Ohio.

HUDSON RIVER BRIDGE AT Poughkeepsie. A lecture by T. C. Clarke, C. E., in the Sibley College Course. General description, Foundations, Superstructure, Temporary Staging, Trestle Work With 3 engravings. Contained in SCIENTIFIC AMERICAN SUPPLEMENT, No. 646. Price 10 cents. To be had at this office and from all newsdealers.

THE MODERN ICE YACHT. BY Geo. W. Polk. A new and valuable paper, containing full practical directions and specifications for the construction of the fastest and best kinds of Ice Yachts of the latest, most approved forms. Illustrated with engravings drawn to scale, showing the form, position, and arrangement of all the parts. Contained in SCIENTIFIC AMERICAN SUPPLEMENT, No. 624. Price 10 cents. To be had at this office and from all newsdealers.

ARTESIAN Wells, Oil and Gas Wells, drilled by contract to any depth, from 60 to 3000 feet. We also manufacture and furnish everything required to drill and complete same. Portable Horse Power and Mounted Steam Drilling Machines for 100 to 600 ft. Good Catalogue for illustrated catalogue. Pierce Artesian and Oil Well Supply Co., 80 Beaver Street, New York.

DELAFIELD'S PAT. SAW CLAMP
With saw for cutting metals. Saves all the broken back-saw blades. In use over two years in all parts of the country. The new clamps have the edges beveled that hold the saw. By mail, with one blade, 50 cents. Extra blades 8 1/2" x 1/2", "Star," 7 cents each, 70 cents per dozen, by mail. Blades 8" x 1/2", "Stubs," 35 cents each, by mail. Discount to dealers. NOROTON MFG. WORKS, Noroton, Conn.

NEW YORK TRADE SCHOOLS, First Avenue, 67th and 68th Streets. Evening instruction commences October 24th, in bricklaying, plastering, Stone cutting, carpentry, plumbing, house and fresco painting, and blacksmith work. Terms moderate. DAY CLASSES Commence December 3d, in plumbing, and in house, sign and fresco painting. A three months' course in each for \$35. Send postal card for illustrated circular.

CITY OF LONDON AND SOUTHWARK SUBWAY. Description of a new underground railway now in course of construction in London. With 7 figures. Contained in SCIENTIFIC AMERICAN SUPPLEMENT, No. 626. Price 10 cents each. To be had at this office and from all newsdealers.

OIL ENGINES. For Printers, Steam Yachts, pumping water, sawing wood, making ice-cream, Carpenters, Mechanics, 1 to 8 H. P. Fuel, Kerosene, No dust. Automatic fuel and water supply. Illustrated Catalogue free. See illustrated notice in Sci. Am. Aug. 4, 1888. SHIPMAN ENGINE CO. 92 Pearl St., Boston, Mass.

Sectional Steam Engine Model. Goodnow & Wightman BOSTON, MASS. Illustrates the action of slide valve. Length of model 46 inches. Valuable to students and young mechanics. Price \$2.00. Postage 35c. Catalogues Free.

SHIP WAVES. BY SIR WILLIAM THOMSON. A lecture delivered before the Institution of Mechanical Engineers. Definition of wave. The different kinds of waves. Waves produced in water by boats and the wind. How the wave procession is kept up. Effect of a ship's build in causing waves: With eight figures. Contained in SCIENTIFIC AMERICAN SUPPLEMENT No. 615. Price ten cents. To be had at this office and from all newsdealers.

GAS ENGINEERING, RECENT PROGRESS IN. BY A. Macpherson. Regenerative system of retort firing. Improvements in gas purification. Burners and regenerative lamps. The Welsbach gas light, Paraffin as a rival of coal gas, oil in gas making. Prices of residual products. Contained in SCIENTIFIC AMERICAN SUPPLEMENT, No. 601. Price 10 cents. To be had at this office and from all newsdealers.

OIL WELL SUPPLY CO. Ltd. 91 & 92 WATER STREET, Pittsburgh, Pa., Manufacturers of everything needed for ARTESIAN WELLS for either Gas, Oil, Water, or Mineral. Tests, Boilers, Engines, Pipe, Cordage, Drilling Tools, etc. Illustrated catalogue, price lists and discount sheets on request.

GUILD & GARRISON BROOKLYN, N. Y., U. S. A. Builders of Steam Pumps for Liquids or Semi-liquids. High Grade Vacuum Pumps, Filter Press Pumps, Air Compressors, Acid Blowers, Feed Pumps, Agitators, Condensers for Pans, Engines, Steam Pumps, Vacuum Apparatus, etc.

SYSTEMS OF DISTRIBUTION OF Electricity. A lecture by Elihu Thomson, delivered in the Sibley College course. The series, multiple arc, series multiple and multiple series, accumulator and induction systems described, and their advantages and disadvantages discussed. With 18 figures. Contained in SCIENTIFIC AMERICAN SUPPLEMENT, No. 603. Price 10 cents. To be had at this office, and from all newsdealers.

VELOCITY OF ICE BOATS. A COLLECTION of interesting letters to the editor of the SCIENTIFIC AMERICAN on the question of the speed of ice boats, demonstrating how and why it is that these craft sail faster than the wind which propels them. Illustrated with 10 explanatory diagrams. Contained in SCIENTIFIC AMERICAN SUPPLEMENT, No. 614. Price 10 cents. To be had at this office and from all newsdealers.

NEW CATALOGUE OF VALUABLE PAPERS Contained in SCIENTIFIC AMERICAN SUPPLEMENT, sent free of charge to any address. MUNN & CO., 361 Broadway, New York.

CARY & MOEN STEEL WIRE OF EVERY DESCRIPTION & STEEL SPRINGS. NEW YORK CITY

ELECTRIC LIGHT AND POWER. Edison system of Arc and Incandescent Lighting. Direct or in connection with the Storage Batteries of the Electrical Accumulator Co., Dynamoelectric Motors, Lamps, Batteries, and General Electric Supplies. THE ELECTRO DYNAMO COMPANY, 224 Carter Street, Philadelphia, Pa.

DESIGNS. Box, F. Davenport..... 18,623
Braid, V. Schuck..... 18,611
Button, I. L. Goff..... 18,628
Cans, jars, etc., top for, S. G. Curtice..... 18,622
Carpet, E. Fisher..... 18,625
Carpet, H. Horan..... 18,630 to 18,632
Carpet, W. L. Jacobs..... 18,634, 18,635
Carpet, J. McMann..... 18,637, 18,638
Carpet, E. Poole..... 18,639
Carpet, C. W. Swapp..... 18,642
Carpet, G. C. Wright..... 18,643
Glassware, T. A. Baker..... 18,621
Grinding mills, hopper for, P. Hobler..... 18,629
Jewelry, setting for, H. Huestis..... 18,633
Stand, ornamental, J. Ruedeker..... 18,640
Stove, lamp, J. De Mooy, Jr..... 18,624
Table cover, D. B. Kerr..... 18,626
Type, font of printing, F. C. Foster..... 18,623, 18,627

TRADE MARKS. Canned fruits and vegetables, Curtice Brothers Company..... 15,889
Canned lobster and salmon, Delafield, Morgan, Kissel & Co..... 15,891
Cigars, G. Fehl & Co..... 15,893
Coffee, roasted, J. H. Brown..... 15,907
Collars, sweat pads for horse, E. L. McClain..... 15,900
Cordial, kidney, Patton Bros..... 15,902
Cure for seasickness, F. B. Perdomo..... 15,909
Cutlery and edge tools, A. F. Shapleigh Hardware Company..... 15,905
Engraving on metal, tools used in, A. Gardon..... 15,896
Fire extinguishing powder, L. Buchbinder..... 15,897
Fruits, dried or preserved, Delafield, Morgan, Kissel & Co..... 15,890, 15,892
Medical cordials, A. G. Franklin..... 15,819
Medicated waters, M. Gessler..... 15,878
Medicinal spring water, Missisquoi Mineral Springs Company..... 15,901
Medicine, cough, S. D. Vansickle..... 15,906
Medicine for diseases of the blood, nerves, and digestive organs, Rothschild Bros. & Co..... 15,904
Pork and beef products and lard, J. H. Brown..... 15,886
Rubber boots and shoes, Hamilton Brown Shoe Company..... 15,897
Salt, J. Corbett..... 15,888
Soap, laundry and toilet, J. W. Popham & Co..... 15,903
Tableware, metal, Holmes & Edwards Silver Company..... 15,898
Tea, Mutual Benefit Tea Company..... 15,908
Wire rope, A. Leschens & Sons Rope Company..... 15,899

A Great Repository of Practical and Scientific Information.

One of the Fullest, Freshest, and Most Valuable Handbooks of the Age. Indispensable to Every Practical Man.

NOW READY. Price \$2.00. Free of Postage to any Address in the World.

The Techno-Chemical Receipt Book.

Containing Several Thousand Receipts covering the Latest, most important, and most Useful Discoveries in Chemical Technology, and their Practical Application in the Arts and Industries.

Price \$2.00, by mail, free of postage to any address in the world. A circular of 32 pages, showing the full Table of Contents of this important Book, sent by mail free of postage to any one in any part of the World who will furnish his address.

HENRY CAREY BAIRD & CO., INDUSTRIAL PUBLISHERS, BOOKSELLERS & IMPORTERS. S10 Walnut St., Philadelphia, Pa., U. S. A.

HASWELL'S ENGINEERS' POCKET-BOOK

Engineers' Pocket-Book. Mechanics' and Engineers' Pocket-Book of Tables, Rules, and Formulas pertaining to Mechanics, Mathematics, and Physics: including Areas, Squares, Cubes, and Roots, &c.; Logarithms Hydraulics, Hydrodynamics, Steam and the Steam-Engine, Naval Architecture, Masonry, Steam-Vessels, Mills, &c.; Limes, Mortars, Cements, &c.; Orthography of Technical Words and Terms, &c. Fifty-second Edition. By CHAS. H. HASWELL. 12mo, Pocket-Book Form, \$4.00.

Capt. J. ERICSSON to the Author. "I cannot find words to express my admiration of the skill and industry displayed in producing this work. To you belongs the honor of having presented to the world a book containing more positive information than was ever before published. I could with justice say more."

It covers the entire practical field of the mechanic—Chicago Inter-Ocean. No book in the guise of a vade mecum has arrived at such popularity in the United States.—N. Y. Times.

HARPER & BROTHERS, NEW YORK.

The above work is for sale by all booksellers, or will be sent by HARPER & BROTHERS, postage prepaid, to any part of the United States or Canada, on receipt of the price. HARPER'S CATALOGUE sent on receipt of Ten Cents in stamps.

WATER MOTORS.

The most efficient and economical means of obtaining from one-eighth to fifteen horse power and upward. A motor which does the greatest amount of work with the use of the smallest stream of water, specially adapted for running cheaply and efficiently, Printing Presses, Elevators, Church Organs, Coffee Mills, Sewing Machines, Lathes, Dental Contrivances, and in fact, any piece of Mechanism.

Binghamton Hydraulic Power Co., 152 State Street, Binghamton, N. Y.

WATCHMAKERS

Send for REDUCED PRICE LIST of Whitcomb Lathes, date of July 1, 1888. American Watch Tool Co., Waltham, Mass.

THE MIND CURE.—BY MARY J. FINLEY, M.D. A review of the theory of metaphysical healing in its relation to physiology and pathology. Contained in SCIENTIFIC AMERICAN SUPPLEMENT, No. 627. Price 10 cents. To be had at this office and from all newsdealers.

TIGHT & SLACK BARREL MACHINERY

A SPECIALTY OF JOHN GREENWOOD & CO. ROCHESTER N. Y.

PHTHISIS.—A PAPER BY DR. H. C. WOOD, describing in detail the new treatment of consumption by sulphureted hydrogen. Contained in SCIENTIFIC AMERICAN SUPPLEMENT, No. 594. Price 10 cents. To be had at this office and from all newsdealers.

WELLS BROTHERS & CO., GREENFIELD, MASS.

Manufacturers of Screw Cutting Machinery and Tools, Flat Bars, Adjustable Dies, Bolt Cutters and Nut Tappers. New Little Giant Screw Plates, &c., &c.

DUPLIX GAS REGULATOR CO. City, country, and state rights for sale. On exhibition at 105 West 41st Street, New York.

PERFECT NEWSPAPER FILE

The Koch Patent File, for preserving newspapers, Magazines, and pamphlets, has been recently improved and price reduced. Subscribers to the SCIENTIFIC AMERICAN and SCIENTIFIC AMERICAN SUPPLEMENT can be supplied for the low price of \$1.50 by mail, or \$1.25 at the office of this paper. Heavy board sides; inscription "SCIENTIFIC AMERICAN" in red. Necessary for every one who wishes to preserve the paper. Address MUNN & CO., Publishers SCIENTIFIC AMERICAN.

CURE FOR THE DEAF

PECK'S PATENT IMPROVED ORSIGNED EAR DRUMS Perfectly Restore the Hearing, whether deafness is caused by colds, fevers or injuries to the natural drums. Invisible, comfortable, always in position. Music, conversation, and speech heard distinctly. Write to F. HISCOX, 853 Broadway, cor. 14th St., New York, for illustrated book of proofs FREE.

ASBESTOS PIPE COVERINGS

Made entirely of ASBESTOS. Absolutely Fire Proof. BRAIDED PACKING, MILL BOARD, SHEATHING, CEMENT, FIBRE AND SPECIALTIES. CHALMERS-SPENCE CO., FOOT E. 8TH ST., N. Y. BRANCHES: Phila, 24 Strawberry St. Chicago, 86 E. Lake St. Pittsburg, 37 Lewis Block.

HYPNOTISM IN FRANCE.—AN INTERESTING review of the present status of this subject, by Max Dessoir. Contained in SCIENTIFIC AMERICAN SUPPLEMENT, No. 613. Price 10 cents. To be had at this office and from all newsdealers.

Use Adamant Wall Plaster

IT IS Hard, Dense & Adhesive —DOES NOT— CHECK OR CRACK. It is impervious to wind, water, and disease germs. It dries in a few hours. It can be applied in any kind of weather. It is in general use. Licenses granted for the mixing, using, and selling. Address, ADAMANT MFG. CO., 71 E. GENESEE STREET, Syracuse, N. Y.

HOME-MADE INCUBATOR.—PRACTICAL directions for the manufacture of an effective incubator that has been carefully tested and found to perform all that may be reasonably expected; with directions for operating. With 4 figures. Contained in SCIENTIFIC AMERICAN SUPPLEMENT, No. 630. Price 10 cents. To be had at this office and from all newsdealers.

SECTIONAL INSULATED AIR COVERINGS FOR PIPES, BOILERS, DRUMS, AND ALL OTHER HOT & COLD SURFACES. SHIELDS & BROWN CO., 142 WORTH ST., NEW YORK.

NATURAL GAS INDUSTRY AT PITTSBURGH, Pa.—A brief history of the Chartiers Valley Gas Company. With 5 illustrations. Contained in SCIENTIFIC AMERICAN SUPPLEMENT, No. 627. Price 10 cents. To be had at this office and from all newsdealers.

THE PENNA. DIAMOND DRILL & MFG. CO. HIRDSBORO, PA. Builders of High Class Steam Engines, Diamond Drilling and General Machinery. Flour Mill Rolls Ground and Grooved.

HOW TO MAKE AN INCUBATOR.—Full directions, illustrated with 7 figures. Also directions for operating the apparatus. Contained in SCIENTIFIC AMERICAN SUPPLEMENT, No. 612. Price 10 cents. To be had at this office and from all newsdealers.

The TRENTON ENGINE

HARRISON CONVEYOR! For Handling Grain, Coal, Sand, Clay, Tan B.rk, Cinders, Ores, Seeds, &c. BORDEN, SELLECK & CO., Sole Manufacturers, Chicago, Ill.

HOW TO MAKE THE WIMSHURST Influence Machine.—Directions for making a cheap and simple but efficient machine. With one figure. Contained in SCIENTIFIC AMERICAN SUPPLEMENT, No. 646. Price 10 cents. To be had at this office and from all newsdealers.

Woodworking Machinery

FOR Chair, Furniture and Cabinet Mills, Pattern Makers' use etc. Rollstone Machine Co., 48 Water Street, Fitchburg, Mass.

2nd MACHINERY

PNEUMATIC DYNAMITE TORPEDO Gun.—An exhaustive account of this new weapon and of the experiments made with it; along with a description and illustration of a proposed dynamite cruiser, with 6 figures. Contained in SCIENTIFIC AMERICAN SUPPLEMENT, No. 593. Price 10 cents. To be had at this office and from all newsdealers.

WELLS Encyclopedia of 700 Engravings of WELLS TOOLS, Diamond Drills and Lightning Hydraulics. American Well Works, Aurora, Ill. Book free, 25c for mailing it.

PENSIONS \$80,000,000 for Soldiers or parents. PENSIONS INCREASED. Discharges procured. 127 No pension, NO FEE. Latest law pamphlet free! PATRICK O'FARRELL, Att'y, Washington, D.C.

ICE-BOATS — THEIR CONSTRUCTION and management. With working drawings, details, and directions in full. Four engravings showing mode of construction. Views of the two fastest ice-sailing boats used on the Hudson river in winter. By H. A. Horsfall, M.E. Contained in SCIENTIFIC AMERICAN SUPPLEMENT, No. 1. The same number also contains the rules and regulations for the formation of ice-boat clubs, the sailing and management of ice-boats. Price 10 cents.

ASBESTOS FELTING WKS. Hair-Felt Cement Felting Coverings 98 Maiden Lane, N.Y. For Heater, Steam & Water Pipes

CLARK'S NOISELESS RUBBER WHEELS No More Splintered Floors. Different Styles. Catalogue Free. Geo. P. Clark, Box L. Windsor Locks, Ct.

\$10.00 to \$50.00 per night. A light and profitable business. Magic Lanterns and Views of popular subjects. Catalogue on application. Part I Optical, 2 Mathematical, 3 Meteorological, 4 Magic Lanterns, etc. L. MANASSE, 88 Madison Street, Chicago, Ill.

ICE & REFRIGERATING

Machines. York Patent. YORK MFG. CO., York, Pa.

COMPLETE STEAM PUMP ONLY SEVEN DOLLARS DEMAND THIS PUMP OF YOUR DEALER OR WRITE TO US FOR PRICES. VAN DUZEN'S PATENT VANDUZEN & TIFT. SOLE MAKERS CINCINNATI, O.

WOOL HAT MAKING.—FULL DESCRIPTION of the process.—W of washing, carding and forming, setting, pumping and washing out, stretching or stumping, drying, storing and steaming, pulling out, dyeing, blocking, storing, pressing, finishing, rounding, curling and ironing, maring, trimming and shaping, relating to with 30 figures. Contained in SCIENTIFIC AMERICAN SUPPLEMENT, Nos. 626, 628, and 629. Price 10 cents each. To be had at this office and from all newsdealers.

OTTO GAS ENGINES. Over 25,000 Sold. Horizontal Otto Gas Engines. Vertical Otto Gas Engines. Twin Cylinder Otto Gas Engines. Combined Otto Gas Engines and Pumps. Combined Otto Gas Engines and Dynamoes. OTTO GAS ENGINE WORKS, CHICAGO, PHILADELPHIA. New York Agency, 18 Vesey Street.

ALCOHOL SWEET POTATO.—AN account of a new industry recently established at the Azores—that of the distillation of alcohol from raw sweet potatoes. Contained in SCIENTIFIC AMERICAN SUPPLEMENT, No. 572. Price 10 cents. To be had at this office and from all newsdealers.

The CUSHMAN Patent 3 Pinion Geared Scroll Chucks with their latest improvements are unexcelled. Made in all sizes from 2 1/2 inch to 12 inch diameter, and are sold by the trade all over the world. Manufactured by The Cushman Chuck Co., Hartford, Conn.

CAMERA BELLOWS.—FULL DESCRIPTION. With 12 figures, by means of which any amateur can easily make a camera bellows for himself. Contained in SCIENTIFIC AMERICAN SUPPLEMENT, No. 625. Price 10 cents. To be had at this office and from all newsdealers.

AUTOMATIC CUT-OFF BALANCE VALVE Highest duty, economy, and durability guaranteed. Phenix Iron Co., Trenton, N. J., Mfrs. F. VAN WINKLE, Agt., 91 Liberty St., N. Y.

THE ECLIPSE Copying Apparatus One thousand copies in black. No special paper, no stencil, no special pen required. The natural handwriting is so exceeding faithfully reproduced that in most cases "Eclipse" Circulars have been taken for ordinary written letters. Circular and specimen on application. FELIX F. DAUS & CO., 698 Broadway, New York.

IRRIGATING MACHINERY ON THE Pacific Coast.—By John Richards. An elaborate discussion of the modifications that have had to be made in irrigating machinery to meet the requirements of local conditions in California. Contained in SCIENTIFIC AMERICAN SUPPLEMENT, Nos. 624 and 625. Price 10 cents each. To be had at this office and from all newsdealers.

BARREL, KEG, Hogshead, AND STAVE MACHINERY. Over 50 varieties manufactured by E. & B. HOLMES, BUFFALO, N. Y.

GOLD MINING MACHINERY.—DESCRIPTION of some new mining plants constructed in England for use in the Transvaal, Austria and Hungary. With 10 figures. Contained in SCIENTIFIC AMERICAN SUPPLEMENT, No. 593. Price 10 cents. To be had at this office and from all newsdealers.

MODEL and EXPERIMENTAL WORK SPECIALTY. Send for Circulars. C. E. Jones & Bro. CINCINNATI, O. (Mention this Paper.)

FIRE-BRICK.—BY R. A. COOK, A.M. An interesting description of the mining of fire clay and the manufacture of the brick at Mt. Savage, Maryland where is located one of the largest establishments in the country devoted to this industry. Contained in SCIENTIFIC AMERICAN SUPPLEMENT, No. 538. Price 10 cents. To be had at this office and from all newsdealers.

Shepard's New \$60 Screw-Cutting Foot Lathe Foot and Power Lathes, Drill Presses, Scroll Saw Attachments, Chucks, Mandrels, Twist Drills, Dogs, Calipers, etc. Lathes on trial. Lathes on payment. Send for catalogue of Outfits for Amateurs or Artisans. Address H. J. SHEPARD, AGENT, 134 East 4th Street, Cincinnati, Ohio.

VOLNEY W. MASON & CO. FRICTION PULLEYS CLUTCHES and ELEVATORS PROVIDENCE, R. I.

THE TOWN OF LINDSAY

Is desirous of obtaining the services of a good PRACTICAL HYDRAULIC ENGINEER. Must be well acquainted with all the modern principles for supply of water for domestic and fire purposes. Testimonials of efficiency required. All communications addressed to the undersigned. THOMAS WALTERS, Mayor of Lindsay, Ontario, Canada.

PARIS UNIVERSAL EXPOSITION OF 1889.

OFFICE OF THE U. S. COMMISSION, 35 WALL STREET, NEW YORK. All persons, firms, or corporations who desire to make exhibits at the above named Exposition are hereby notified that information and blanks for applications for space will be furnished by the undersigned upon application at the above address. WM. B. FRANKLIN, Com'r General. SOMERVILLE P. THICK, Ass't Com'r General.

ARCHITECTURAL BOOKS.

Useful, Beautiful, and Cheap.

To any person about to erect a dwelling house or stable, either in the country or city, or any builder wishing to examine the latest and best plans for a church, school house, club house, or any other public building of high or low cost, should procure a complete set of the ARCHITECTS' AND BUILDERS' EDITION of the SCIENTIFIC AMERICAN.

The information these volumes contain renders the work almost indispensable to the architect and builder, and to persons about to build for themselves they will find the work suggestive and most useful. They contain colored plates of the elevation, plan, and detail drawings of almost every class of building, with specifications and approximate cost.

Four bound volumes are now ready and may be obtained, by mail, direct from the publishers or from any newsdealer. Price, \$1.00 a volume. Stitched in paper covers. Subscription price, per annum, \$2.50. Address and remit to

MUNN & CO., Publishers, 361 Broadway, New York.

BIBB'S Celebrated Original BALTIMORE FIRE-PLACE HEATERS To warm upper and lower rooms The Handmade and Most Economical Coal-burners in the World. E. O. EIBB & SON Store Founders, Baltimore, Md. MARBLEIZED SLATE MANTELS Now and Beautiful Designs

THE GENERATION OF STEAM.—A lecture by Geo. H. Babcock delivered in the Sibley College Course. II. The production of Heat. Furnaces for burning bituminous and anthracite coal, wood, sawdust, waste gas, natural gas, etc. described. III. The Generation of Steam. General principles to be observed in the construction of boilers. With 14 figures. Contained in SCIENTIFIC AMERICAN SUPPLEMENT, Nos. 624 and 625. Price 10 cents. To be had at this office and from all newsdealers.

TAKE THE MONON ROUTE BETWEEN Chicago and Louisville, Indianapolis, Cincinnati, and all winter cities. E. O. McCormick, Gen. Pass. Agent, Chicago.

To Electro-Platers. THE VICTOR DYNAMO PLATING MACHINES. Three sizes, \$30, \$60, and \$80. All Batteries and material for Gold, Silver, and Nickel Plating. THOMAS HALL, 19 Bromfield St., Boston, Mass. Send for Illustrated Catalogue.

TALCOTT'S COMBINATION PATENT BELT HOOKS, W. O. TALCOTT, Providence, R. I.

Scientific Book Catalogue

RECENTLY PUBLISHED. Our new catalogue containing over 100 pages, including works on more than fifty different subjects. Will be mailed free to any address on application. MUNN & CO., Publishers Scientific American, 361 Broadway, New York.

BEST SHORT TELEPHONES PRICES REDUCED. Ellsworth's "Ei Eco" Telephones For short lines and speaking tube purposes. \$7.50 per pair. Send two 2-cent stamps for illustrated catalogue and circulars. T. G. ELLSWORTH, 177 West St., N. Y. City.

LEAD SMELTING.—A FULL DESCRIPTION of the Lewis Bartlett process, by William Ramsay; illustrated with 9 engravings. Contained in SCIENTIFIC AMERICAN SUPPLEMENT, No. 593. Price 10 cents. To be had at this office and from all newsdealers.

FACTORY TO LET.

A new 6-story brick building, in Boston, covering nearly 10,000 square feet; well lighted, elevators, steam heat and power. Will let it as a whole, or in parts. Apply to JOHN A. EASTON, 36 Temple Place, Boston (over Bank).

TELESCOPE For Sale. Ten inch silver glass equatorial mount. F. M. B., 257 S. Market, Springfield, O.

The Scientific American PUBLICATIONS FOR 1888.

The prices of the different publications in the United States, Canada, and Mexico are as follows: RATES BY MAIL. The Scientific American (weekly), one year \$3.00 The Scientific American Supplement (weekly), one year 5.00 The Scientific American, Export Edition (monthly) one year 5.00 The Scientific American, Architects and Builders Edition (monthly), one year 2.50 COMBINED RATES. The Scientific American and Supplement, \$7.00 The Scientific American and Architects and Builders Edition, 5.00 The Scientific American, Supplement, and Architects and Builders Edition, 9.00 Proportionate Rates for Six Months. This includes postage, which we pay. Remit by postal or express money order, or draft to order of MUNN & CO., 361 Broadway, New York.

Advertisements.

Inside Page, each insertion --- 25 cents a line. Back Page, each insertion --- \$1.00 a line.

The March of Progress! OUR LATEST IMPROVEMENT!

"Competition is the life of trade," and if you have not seen our improved \$1 Shoe, made for the Summer and Fall trade of 1888, you cannot imagine how lively the trade is...

JAMES MEANS' \$3 SHOE UNEXCELLED IN STYLE UNEQUALLED IN DURABILITY AND PERFECTION OF FIT. SEAMLESS \$3 SHOE. JAMES MEANS' \$4 SHOE CANNOT FAIL TO SATISFY THE MOST FASTIDIOUS.

Such has been the recent progress in our branch of industry that we are now able to affirm that the James Means' \$1 Shoe is in every respect equal to the shoes which only a few years ago were retailed at eight or ten dollars.

Barnes' Foot-Power Machinery Complete outfits for Actual Workshop Business. A customer says: "Considering its capacity and the accuracy of work it does, it is not a bad thing that it can be produced at such low cost."

TO BUSINESS MEN.

The value of the SCIENTIFIC AMERICAN as an advertising medium cannot be overestimated. Its circulation is many times greater than that of any similar journal now published.

THE KODAK CAMERA

100 Instantaneous Pictures! Nobody can use it. No knowledge of photography is necessary. The latest and best outfit for amateurs.

The Eastman Dry Plate & Film Co. ROCHESTER, N. Y.

PATENTS.

MESSRS. MUNN & CO., in connection with the publication of the SCIENTIFIC AMERICAN, continue to examine improvements, and to act as Solicitors of Patents for Inventors.

THE GUTTA PERCHA & RUBBER MFG. CO.

The Largest Manufacturers of Mechanical Rubber Goods in the World. ESTABLISHED 1855. Packing, Belting, Hose, Mats, Matting, etc. New York, Chicago, San Francisco, Portland, Oregon.

The "ALLARD" SPIRAL SCREW DRIVER. For Light and Rapid Work. For Machinists, Gun and Locksmiths, Cabinet Makers and others. The greatest labor saving tool extant.

JAMES B. EADS.—AN ACCOUNT OF THE life and labors of this eminent engineer. With a portrait. Contained in SCIENTIFIC AMERICAN SUPPLEMENT, No. 592. Price 10 cents.

JENKINS BROS. VALVES. CALL FOR AND INSIST ON HAVING. 71 JOHN ST. NEW YORK. 21 North 5th St. PHILA. 105 MILK ST. BOSTON. 54 DEARBORN ST. CHICAGO.

THE COPYING PAD.—HOW TO MAKE and how to use; with an engraving. Practical directions how to prepare the gelatine pad, and also the aniline ink by which the copies are made.

COPPER TUBES. SHEET BRASS BRASSWIRE. MENTION THIS PAPER.

ELECTRIC CONVEYERS.—DESCRIPTION of two ingenious systems for the electric carriage of small packages. Illustrated with 13 engravings. Contained in SCIENTIFIC AMERICAN SUPPLEMENT, No. 434. Price 10 cents.

KEUFFEL & ESSER, New York. INDELIBLE DRAWING INKS. Black, Brown, Blue, Green, Scarlet, Carmine, Yellow. The best ever produced.

NEW GAS ENGINE

"The Baldwin" A four horse-power engine in connection with storage battery, running 84 incandescent electric lights (and without battery, 32 lights), giving a perfect light, with all the steadiness that can be obtained from the high-speed steam engines in common use for electric lighting.

NAVAL ARCHITECTURE.—AN interesting review, by Mr. R. Duncan, of the progress that has been made in this branch of science during the last fifty years. Contained in SCIENTIFIC AMERICAN SUPPLEMENT, No. 589. Price 10 cents.

ESTABLISHED HALF A CENTURY. MARVIN'S FIRE & BURGLAR SAFES. HAVE MANY PATENTED IMPROVEMENTS NOT FOUND IN OTHER MAKES THAT WILL WELL REPAY AN INVESTIGATION BY THOSE WHO DESIRE TO SECURE THE BEST SAFE.

THE FORTH BRIDGE.—A PAPER BY A. S. Higgart, describing the method employed in the erection of this great engineering work. With 8 figures. Contained in SCIENTIFIC AMERICAN SUPPLEMENT, No. 624. Price 10 cents.

RUBBER BELTING, PACKING, HOSE. Oldest and Largest Manufacturers in the United States. VULCANIZED RUBBER FABRICS For Mechanical Purposes. Air Brake Hose A SPECIALTY. RUBBER MATS, RUBBER MATTING, AND STAIR TREADS. NEW YORK BELTING & PACKING CO., 15 PARK ROW, N. Y.

STEEL BALLS.

For Anti-Friction Bearings, of Best Cast Steel, Hardened, Ground and Burnished, from 3-16 in. to 2 in. diameter. In quality and density of metal, uniformity of temper, and in accuracy and nicety of finish warranted unequalled.

Simond's Rolling-Machine Co., Fitchburg, Mass.

THE NEW CROTON AQUEDUCT.—Detailed description of the great aqueduct now being constructed to increase the water supply of New York City and also of the great dam which it is proposed to build across the Croton River, at Quaker Bridge.

HARTFORD STEAM BOILER INSPECTION AND INSURANCE CO. CONN. HISTORY OF THE ELECTRICAL ART in the U. S. Patent Office.—By C. J. Kintner. An interesting history of the growth of electrical science in this country.

HISTORY OF THE ELECTRICAL ART in the U. S. Patent Office.—By C. J. Kintner. An interesting history of the growth of electrical science in this country, and notices of some of the more important models in possession of the Patent Office.

THE STANDARD H.W. JOHNS ASBESTOS BOILER COVERINGS. PATENTED. 87 MAIDEN LANE, NEW YORK.

GLACIAL EPOCHS AND THEIR PERIODICITY.—By Adolphe d'Assier. A presentation of the considerations that tend to establish the fact that the progress of the earth must, in the course of ages, have produced circum-polar glaciers, and that the periodic and alternate return of these in the two hemispheres is closely connected with the secular displacement of the perihelion.

LIMITING NUMBERS OF TEETH IN Gear Wheels.—A valuable paper by George B. Grant treating of the different methods of determining the limiting numbers of teeth in gear wheels when small pinions must be used.

MALLEABLE AND FINE GRAY IRON ALSO STEEL CASTINGS FROM SPECIAL PATTERNS. THOMAS DEVLIN & CO. LEHIGH AVE. & AMERICAN ST. PHILA.

PATENT JACKET KETTLES, Plain or Porcelain Lined. Tested to 100 lb. pressure. Send for Lists. H. HAND, BUREAU & CO., 614 and 616 Market St., Philadelphia, Pa.

SYRACUSE MALLEABLE IRON WORKS

QUARANTINE SYSTEM OF LOUISIANA.—By Joseph Holt, M. D. Description of the methods of disinfection practiced. With 4 figures. Contained in SCIENTIFIC AMERICAN SUPPLEMENT, No. 627. Price 10 cents.

AUTOMATIC CUTOFF ENGINES. MANUFACTURED UPON SCIENTIFIC AND PRACTICAL PRINCIPLES. BALL ENGINE CO. ERIE PA.

THE AMERICAN BELL TELEPHONE CO.

This Company owns the Letters Patent granted to Alexander Graham Bell, March 7th, 1876, No. 174,465, and January 30th, 1877, No. 186,787.

The transmission of Speech by all known forms of Electric Speaking Telephones infringes the right secured to this Company by the above patents, and renders each individual user of telephones not furnished by it or its licensees responsible for such unlawful use, and all the consequences thereof, and liable to suit therefor.

TELESCOPES. Spectacles, Barometers, Photographic Outfits for Amateurs, Lantern Slides, Field Glasses, Microscopes, &c. W. H. WALMSLEY & CO., Philadelphia, Pa. Price list free. Send for Special Bargain Lists.

THE Scientific American

ESTABLISHED 1846. The Most Popular Scientific Paper in the World. Only \$3.00 a Year, including Postage. Weekly. 52 Numbers a Year.

This widely circulated and splendidly illustrated paper is published weekly. Every number contains sixteen pages of useful information and a large number of original engravings of new inventions and discoveries representing Engineering Works, Steam Machinery, New Inventions, Novelties in Mechanics, Manufactures, Chemistry, Electricity, Teleggraphy, Photography, Architecture, Agriculture, Horticulture, Natural History, etc.

Terms of Subscription.—One copy of the SCIENTIFIC AMERICAN will be sent for one year—52 numbers—postage prepaid, to any subscriber in the United States or Canada, on receipt of three dollars by the publishers; six months, \$1.50; three months, \$1.00.

The safest way to remit is by Postal Order, Draft, or Express Money Order. Money carefully placed inside of envelopes, securely sealed, and correctly addressed, seldom goes astray, but is at the sender's risk. Address all letters and make all orders, drafts, etc., payable to MUNN & CO., 361 Broadway, New York.

THE Scientific American Supplement.

This is a separate and distinct publication from THE SCIENTIFIC AMERICAN, but is uniform therewith in size, every number containing sixteen large pages full of engravings, many of which are taken from foreign papers, and accompanied with translated descriptions.

The most important Engineering Works, Mechanisms, and Manufactures at home and abroad are illustrated and described in the SUPPLEMENT. Price for the SUPPLEMENT for the United States and Canada, \$5.00 a year, or one copy of the SCIENTIFIC AMERICAN and one copy of the SUPPLEMENT, both mailed for one year for \$7.00.

Builders Edition.

THE SCIENTIFIC AMERICAN ARCHITECTS' AND BUILDERS' EDITION is issued monthly. \$2.50 a year. Single copies, 25 cents. Forty large quarto pages, equal to about two hundred ordinary book pages, forming a large and splendid Magazine of Architecture, richly adorned with elegant plates in colors, and with other fine engravings; illustrating the most interesting examples of modern Architectural Construction and allied subjects.

MUNN & CO., Publishers, 361 Broadway, New York.

PRINTING INKS. THE "Scientific American" is printed with CHAS. T. BENEJOHNSON & CO.'S INK. Tenth and Lombard Sts., Phila., and 47 Rose St., opp. Duane St., N. Y.