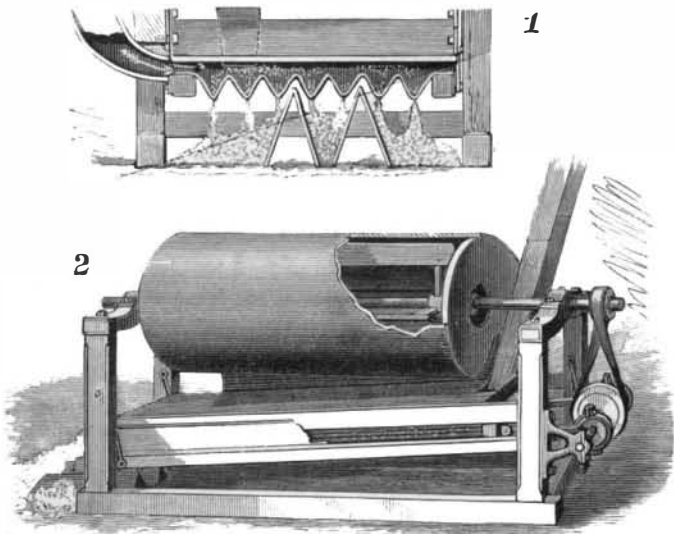

PURIFYING AND SEPARATING MIDLINGS.

The extensive introduction of modern milling machinery has added greatly to the importance of all devices calculated to more thoroughly separate the products at the different stages in the processes of high and low grinding. The illustrations herewith show an improved purifier and separator, Fig. 2 giving a longitudinal sectional elevation, with part of the fan casing broken away, and Fig. 1 showing an end elevation. Beneath the fan, and supported in the same

**HOWARD'S MIDLINGS PURIFIER AND SEPARATOR.**

frame, is a longitudinally corrugated plate, with a downward inclination toward its tail end, and above this plate is another one, which can be adjusted closer to or farther from the corrugated plate, to regulate the effect of the blast of air. As the middlings are passed through the feeder, the corrugated plate is vibrated in connection with the air blast from the blower, spreading the middlings over the surface of the plate, while the vibrations cause the light, fluffy particles and the fine bran to rise to the surface, where they will be blown out by the air blast through the space between the upper and lower plates, while the heavier and more valuable parts will pass down the grooves and escape at their lower ends into any desired receiver, the more valuable portions being in the groove next the fan blower, and becoming less valuable in the grooves toward the other side of the machine. Beneath the lower end of the corrugated plate are placed angular division plates, to separate the products into such degrees of fineness or purity as may be desired.

This invention has been patented by Mr. Edward W. Howard, of Montevideo, Minn.

COTTON CHOPPER ATTACHMENT FOR CULTIVATORS.

Mr. Hans Henriksen, of Duarte, Cal., has patented an improvement in cutting attachments for cultivators which is intended more especially for use in the cotton field, and is so made that it can be adjusted to cultivate the plants and at the same time remove a certain proportion of them, or to be available as a simple cultivator, as may be desired. The mechanism, as will be seen from our engraving, is quite simple. A rod, placed in such a position as to be in line with the axes of the wheels, has the forward ends of the arms of a U-shaped bar pivoted to it in such a manner that the bar can be moved forward or back. At about the center, the bar is bent vertically downward, and, with the aid of the transverse bar joining its two arms, supports the bearings of two vertical shafts.

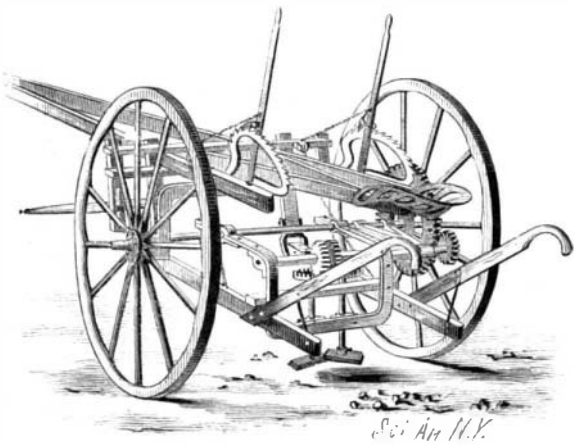
**COTTON CHOPPER ATTACHMENT FOR CULTIVATORS.**

To the upper end of the shafts are attached gear wheels, which engage with pinions on a horizontal shaft supported in bearings at the angles of the U-shaped bar. A pinion on the end of this shaft receives motion from a toothed wheel connected with the right hand wheel of the cultivator. Cutting blades are at-

tached to the lower ends of the vertical shafts at their centers; and the arms of the blades being longer than half the distance between the shafts, will overlap slightly, but as one shaft is shorter than the other, the blades do not interfere. As the blades revolve, a diamond-shaped space is left between the intersections of the paths of each arm, in which the plants are undisturbed. Provision is made for adjusting the position of the vertical shafts and their actuating pinions, so that the blades will intersect more or less as it is desired to remove a greater or less number of plants. When the machine is to be used as a simple cultivator, the blades are replaced by small disks, which leave the plants undisturbed along the whole row.

Both blades and disks operate under the surface to loosen the soil, and the depth to which they penetrate is regulated by the two levers shown on top of the machine. The arrangement of the device makes it both simple and effective.

White Herons.

Among the entertaining features of the State carp ponds are two white herons under domestication. Mr. Logan Terrell winged two of these snow white creatures, and has for some days kept them tied to a pole with a small cord. At times he takes the birds upon his arm, and conveys them to the edge of the large pond. Then, throwing in bits of cracker, he attracts myriads of shiners and roaches near the feet of the birds, who immediately begin to feed. One fish after another is caught between the beak and swallowed head foremost. It is strange that, as slick as a fish is, they never drop one. Each bird takes forty-five fish per day, the minnows being 4 inches long. Mr. Terrell wonders why any fish exist when such greedy foes beset them every day.—*Raleigh Register.*

CUTTING NIPPERS.

In the common nippers, where the rivet or wire to be cut cannot be passed between the sides of the jaws,

**BROADBROOKS' CUTTING NIPPERS.**

the cut is diagonal, and must be made at the ends of the cutting edges. The accompanying engraving represents nippers, the invention of Mr. Peter Broadbrooks, of Batavia, N. Y., which overcome this objection. The two jaw levers have their upper ends forked, and the prongs of one lever pass between the prongs of the other. The prongs are pivoted together by two rivets, one in each pair of prongs, or by a single rivet passing through all four prongs. The cutting blades are held by screws in recesses formed in the upper ends of the levers. In one lever is arranged a stop screw. As the pivoted ends of the levers are forked, an opening is formed between the sides at the pivots, thus permitting of passing a wire between the cutting blades and between the sides of the levers. The wire can thus be cut at the centers of the cutting edges and at right angles to the length of the wire.

REVOLVING CULTIVATOR.

The object of the invention herewith illustrated, which has been recently patented by Mr. John T. Campbell, of Rockville, Ind., is to facilitate and promote thoroughness in cultivating small plants, loosening the soil, and covering grain. The inner ends of eight radial arms are attached to a hub pivoted to the lower end of a short vertical shaft attached to the frame of the machine. The outer ends of the arms are bent upward at right angles and then inward, and in the ends are pivoted steel teeth whose lower parts are bent to the rearward and widened vertically. The sections of the teeth that pass through the upper and lower parts of the outer ends of the arms are made round, so that they will turn freely; and the sections between the upper and lower parts are made square, to correspond with

the square eyes of short bars which are fitted loosely upon the square sections. To the radial arms are attached pins in such positions that the bars will strike against them when the teeth have turned so far in one direction as to bring the blades into radial positions, but will allow the teeth to turn freely in the other direction until the bars come in contact with the edges of the upright parts of the radial arms. When it is desired to have the frame revolve in the other direction, the bars are raised, swung over the pins, and

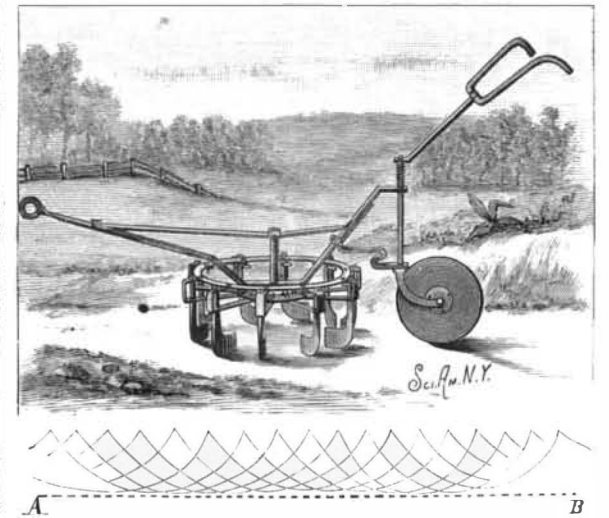
**CAMPBELL'S REVOLVING CULTIVATOR.**

dropped at the other side. The cultivator is made to move forward in a straight line by a circular rudder attached to a vertical rod, the lower end of which is pivoted in the rear end of a bracket secured to the rear inclined bar of the main frame. The handles by which the rudder is controlled, and the machine thereby guided, are attached to the upper end of the vertical rod. When the cultivator is drawn forward, that side upon which the blades are held from swinging back by the rods and pins will be held by the blades from moving forward, while the other side will move forward more quickly, the teeth describing curved lines (the diagram shows clearly the track made by the cultivator, the dotted line A B representing the row of plants, and the curved lines the paths of the blades), and their blades swinging back, and offering less resistance to the advance of that side. The curved forward sweep of the blades causes them to push all clods and lumps away from the plants and at the same time to thoroughly loosen the soil.

IMPROVED TRUNK.

This trunk is so constructed that it can be erected and adapted for use as a wardrobe, desk—as shown in Fig. 2—or table, or can be adjusted as a support for a mattress or other bedding. The trunk is formed of two sections, shown clearly in Fig. 2, hinged to each other; the plane on which the two sections are divided is diagonal, so that when the front section is swung up on the rear one, a wardrobe or box is formed, which increases in width and thickness from top to bottom, and is closed by lids hinged to each other. The rear section is provided with a horizontal partition dividing it into two compartments, and the front or upper section has two horizontal partitions. Vertical partitions form a

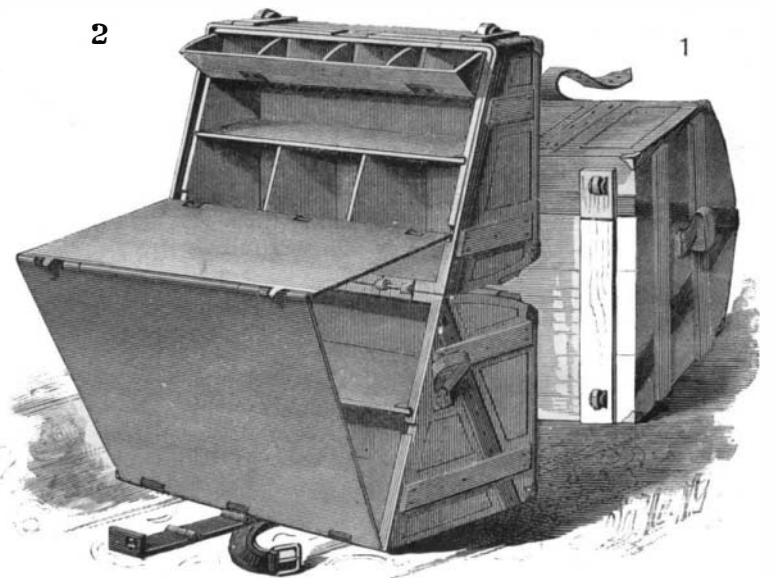
**WULFF'S IMPROVED TRUNK.**

series of compartments in the lower part of the upper section, for holding hats, shirts, or other articles. The upper part of the section is divided into pigeon holes, which can be closed by a swinging leaf formed with partitions corresponding with those making the pigeon holes, and dropping within them when the leaf is closed. The two lower horizontal partitions are hinged

so that they can be folded down against the backs of the compartments when they are not needed. The sections are furnished with lids hinged to each other, the lower one being hinged to the front edge of the bottom of the rear section. By placing the lower lid against its own section and swinging the free end of the upper lid downward and outward, when it may be held at any desired inclination by suitably ar-

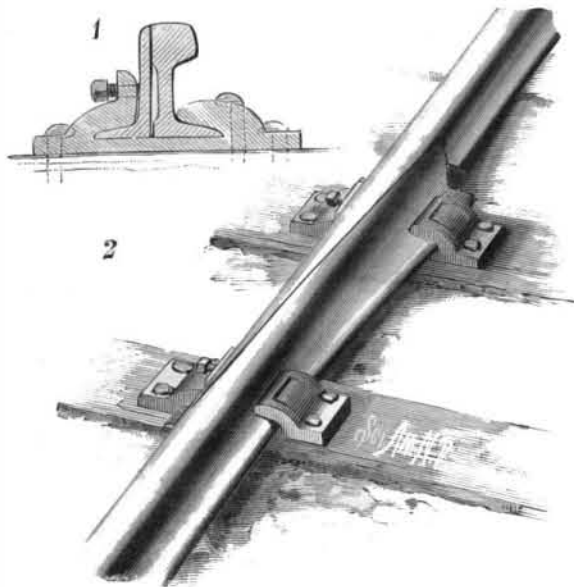

LARKIN'S RAILROAD RAIL JOINT.

ranged straps, a table may be formed. When the lids are on their respective sections, the trunk may be laid down so as to rest on the back of the lower and front of the upper section, thus forming a support for mattresses or bedding. As trunks, in Mexico, are used extensively as furniture, this one ought to prove a good article of manufacture for that country.

This trunk is the invention of Mr. Henry F. Wulff, of San Antonio, Tex.

IMPROVED CAR COUPLER.

The engraving represents a car coupler that will take up the link as it hangs from the mouth of the drawhead to be coupled, and securely couple the same by pressure of the cars in coming together, without the aid or supervision of an attendant. It can be uncoupled at any time, whether the cars are at rest or in motion, from the platform, top, or side of the car; the uncoupling can be performed under any strain or tension, thus avoiding the necessity of "backing up" the engine for the purpose. It can be uncoupled without immediately separating the cars, and so left, when the cars can be drawn apart at any time thereafter, the coupler always assuming at the instant its position for uncoupling automatically. It may be made to couple to heights varying six inches or more.

As the drawhead is moved inward by the cars coming together, the outer end is raised by a bevel formed on its under side sliding upon a flat crosspiece extending across the lower side of the drawhead opening. A flange projecting downward from the crosspiece is pro-

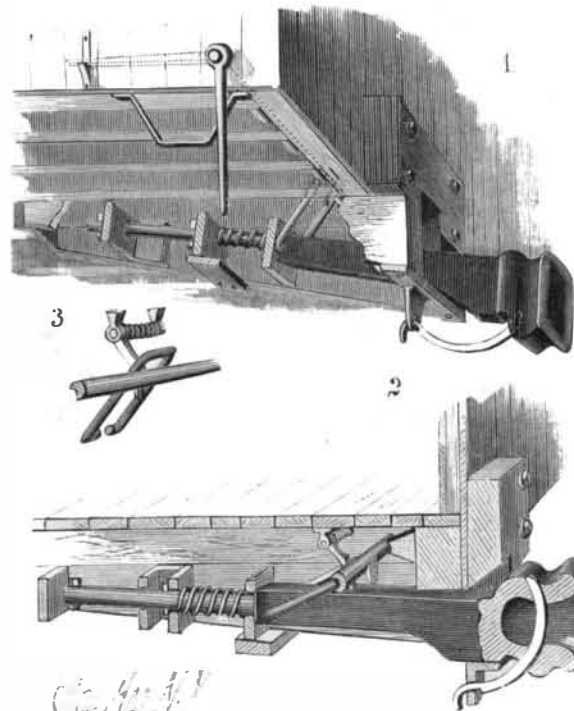

BUCKMAN'S IMPROVED CAR COUPLER.

vided with an aperture, through which a hook on the lower inner end of the curved coupling pin is passed; as the drawhead moves inward, this pin enters suitable openings in the head and holds the link, as will be understood from Fig. 2. The drawhead is held securely in its inner position by a rectangular frame (Fig. 3), whose lower end is pivoted to the rear part of the draw-

head, and whose upper end rests, when coupled, in a longitudinal groove formed in a rod extending across the car, and provided at each end with a handle for turning it, as shown in Fig. 1. The locking link is held securely in place by a cam arm, whose spring presses it against the link. On the cross rod is an arm, which acts, as the rod is turned, to free the end of the locking link when the cars are to be uncoupled. Upon releasing this link, the drawhead can be pulled out a certain distance, and will rest in position (Fig. 1) for coupling.

This invention has been patented by Mr. Thomas E. Buckman, of Jacksonville, Fla.

RAILROAD RAIL JOINT.

Fig. 2 is a perspective view and Fig. 1 a cross section through the joint and one of the chairs of a rail joint invented by Mr. John C. Larkin, of Whitefield, N. H. This joint is designed especially to prevent switch rails from binding, so that they can be set at any time without cutting the ends of the rails. The joint can also be used at any part of the track where it is desired to make allowance for the expansion or creeping of the rails. The rails are by preference made 8 feet long, and the adjacent ends are beveled for a distance of 4 feet, and are placed with their beveled sides overlapping each other. The base flanges of the beveled parts are widened from the beginning of the bevels to the ends of the rails, so that the edges of the flanges will be parallel with the beveled sides of the rails. The beveled parts are placed in chairs firmly spiked to the ties. The rail adjacent to the switch rails is held securely in place by spikes driven through holes in the chairs and recesses in the rails into the ties; this rail is always in such a position as to form a proper joint with the switch rail and allow the latter to be easily set at any time, the movement being wholly confined to the other rail. The arms of the chairs at the side of the movable rail are extended upward along the web of the rail and are provided with set screws, the forward ends of which rest against the rail, so that the wear of the rails can be taken up. The rails are made exactly alike, so that their positions can be reversed when necessary to equalize the wear upon each.

The Change of Foliage.

The immediate cause of the change in the foliage during the fall lies in the lessened action of the breathing organs or pores of the leaves, resulting from a loss of warmth and light due to the shorter days. The natural stimulants to vegetation are withdrawn. Shortly before the fall of the leaf, a very delicate layer of cells starts from the side of the stem and grows downward, completely separating the leaf from any participation in the life circulation of the plant. This explains the smooth surface exposed on separating a mature leaf from its branch. With the cessation of the circulation of the sap, the leaves no longer absorb carbonic acid gas and give off oxygen. The great natural process of deoxidation is arrested, and finally reversed—oxygen is absorbed. The chlorophyl, or leaf green, which gave color to the leaves during the earlier part of the season, is now oxidized and changed to xanthophyl, or leaf yellow, and erethrophyl, or leaf red.

These new salts contribute nothing to the nourishment of the leaf. No carbonic acid is absorbed from the atmosphere, and the leaf soon dies and falls to the ground. The difference in the coloring of the leaves depends upon the local conditions, which hasten, modify, or retard this chemical reaction. In the so-called evergreens, no transverse cell formation takes place, and the leaf is never separated from the circulation of the main tree. They also evaporate less in proportion to their leaf surface than ordinary trees. Their more sluggish circulation is less dependent upon climatic influences.

Right and Left Handed.

A right-handed man is a man who takes hold of a hoe, a rake, a spade, or a fork, with the right hand down and the left hand up, or nearest the body. A man who habitually puts his left hand down, or, for instance, the man who places his right hand on the top of a spade, and grasps the handle or shake with his left hand, is a left-handed man. And so with an ax. A right-handed man and left-handed man can work together in chopping down a tree. If they were both right-handed or both left-handed, they could not do this unless one chopped on one side of the tree and the other on the other side. And so it is in loading earth into a wagon. If the men stand face to face, one should be left-handed and the other right-handed. In hoeing a row of corn, the right-handed man will walk on the left side of the row, while the left-handed man will walk on the right side of it.

DUMPING CAR.

The improved dumping car herewith illustrated unloads either sidewise or endwise, and is so constructed that the car and load cannot be thrown off the track when running on an uneven surface. The truck bed is provided with a pin projecting into the bed plate, and with friction rollers on which a disk, projecting a short distance beyond the bed plate, rests. One side of

the bedplate is inclined, as shown in both drawings. To facilitate unloading, the front end of the car is a trifle wider than the rear. The car body is attached to a frame consisting of side and end beams and a center beam; the latter is hinged to the upper edge of the incline, and the side beams rest on the end beams of the truck frame, as shown in the sectional view, Fig. 1. At the front end of the body is a hinged door, which can be locked or unlocked from the rear by a bent rod. Secured to either the side or rear is a handle, by which the body can be turned on the pin. The brake shoes are operated by cams placed on the ends of a central rod moved by a lever.

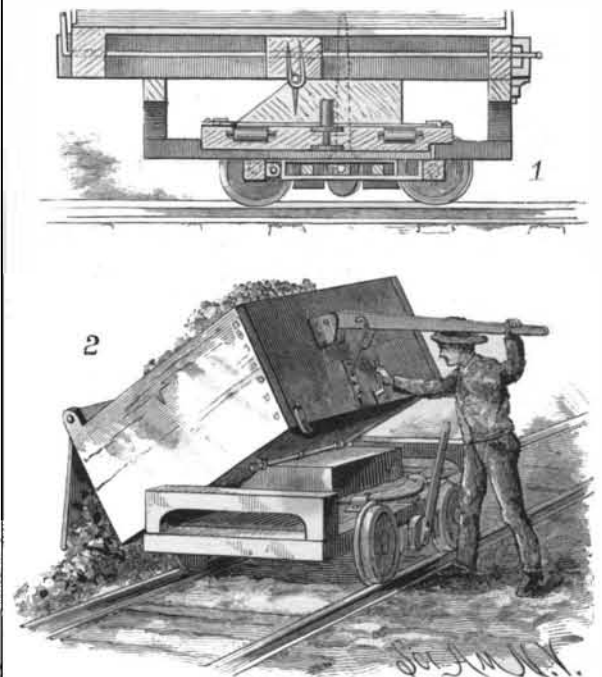

COOK & SUMMERS' DUMPING CAR.

The load is dumped sidewise by unlocking the car frame, unfastening the hinged door by turning the bent rod downward, and then swinging the car body at right angles—to the position shown in Fig. 1—by means of the handle. As soon as the car frame has cleared the end beams of the truck frame, it will tip over on to the incline, as shown in Fig. 2. The load can be dumped endwise by lifting the rear end of the car upward, using the front axle as the pivotal center; the rear wheels remain on the track, as the rear axle is hinged to the front one by a frame. By removing the car body, frame, and bed plate, the truck can be used as a timber car.

This invention has been patented by Mr. S. W. Cook and Henry Summers, of Bozeman, Montana.

THE "MONARCH" CHURN.

The operation of this churn will be readily understood by reference to the accompanying illustration, by which it will be seen that, on simply drawing it across the floor or the ground, motion is communicated to cog wheels operating the dasher. The blades of the dasher are set at an angle, to effect a thorough agitation of the cream, and the lower edges of the lower blades are made to conform to a conical shape of the bottom, formed around the step in which the upright dasher shaft rests. The body of the churn, which is preferably of sheet metal, is so supported that but-



PHILLIPS' IMPROVED CHURN.

termilk can be conveniently drawn off at a stopper in the bottom, and it is so hung that it may be readily swung and locked in place for churning, or readily thrown out of such position, to facilitate filling with cream or removing the butter.

This invention has been patented by Mr. Ezra O. Phillips, of Coopersville, Mich.